

Piranha Color PC-30

Line Scan Cameras



Overview

Dream in color—high speed, high resolution, high fidelity color.

The Piranha Color cameras deliver superb color fidelity at the fastest line rates and highest resolutions in the industry. The RGB trilinear sensor eliminates artifacts associated with prism cameras by placing a separate row of pixels for each color on a single sensor die. Our advanced design minimizes distance between rows (equivalent to three pixels center-to-center) to minimize image artifacts due to synchronization.

The result is higher quality images at higher speed. With a single power supply and Camera Link interface, the camera is both easy to use and powerful, offering programmable gains and offsets for each color.

If you're dreaming in color, take a look at a Piranha color camera. Dreams do come true.

Key Features

- 2k or 4k color trilinear sensor
- 3 pixel center-to-center spacing between pixel rows
- Spatially corrected output
- Forward and reverse scanning
- 32.3 kHz (2k) or 17.6 kHz (4k) maximum line rates
- Base or Medium Camera Link

Programmability

- Programmable flat field correction and white balancing
- Programmable gain and offset
- 8 or 12 bit output
- Adjustable integration time and line rate
- Test pattern, line statistics, and camera diagnostics

Typical Applications

- 100% print inspection
- Electronic manufacturing inspection
- Postal/parcel sorting
- High performance document scanning/image lift
- Full web inspection
- High-end industrial inspection
- Food inspection

Specifications

Resolution	2048 pixels / 4096 pixels
Data Rate	3 x 60 MHz or 80 MHz
Max. Line/Frame Rate	32.3 kHz / 17.6 kHz
Pixel Size	14 μm x 14 μm (2k) 10 μm x 10 μm (4k)
Data Format	8 bit, 12 bit selectable
Output	Base or Medium Camera Link
Lens Mount	F mount or M72 x 0.75
Responsivity	see graph
Dynamic Range	> 50 dB
Nominal Gain Range	± 10 dB
Size	76 mm x 105 mm x 50 mm
Mass	< 450 g
Operating Temp	0 °C to 50 °C
Power Supply	12 V to 15 V
Power Dissipation	12 W
Regulatory Compliance	CE
Control	MDR26 Camera Link
Data	Shared with Control
Power	Hirose HR10 6 pin
Example Part Number	PC-30-04K80

Piranha Color PC-30

Line Scan Cameras

The Piranha Color camera uses a trilinear CCD sensor with 3 lines of pixels: one blue, one red and one green.

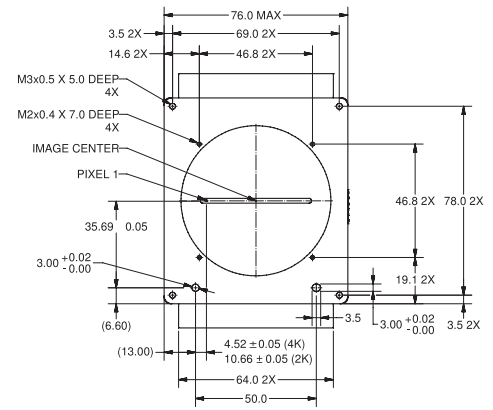
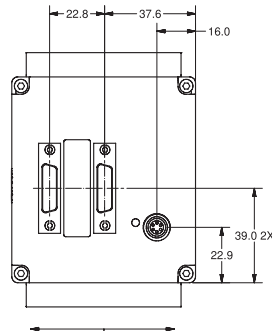
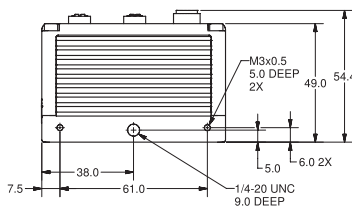
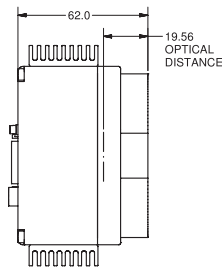
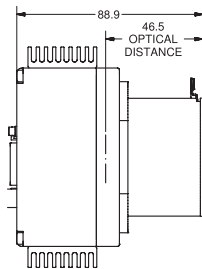
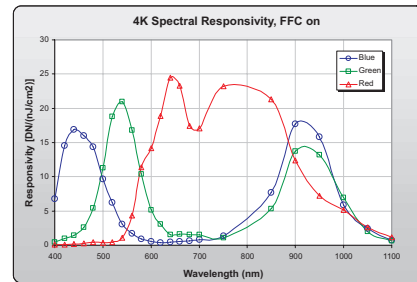
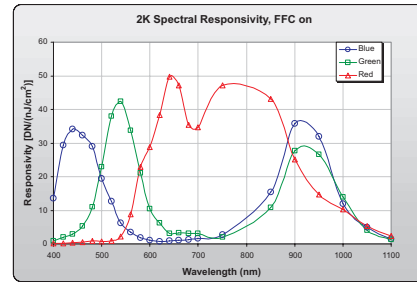

NOTES:
 1) TOLERANCE (UNLESS OTHERWISE SPECIFIED)
 .XX ±.30
 .X ±.5
 2) ROTATION WRT CAMERA EDGE IS 2 MAX

UNITS: MM

www.teledynedalsa.com

Americas

Boston, USA
 Tel: +1 978-670-2000
sales.americas@teledynedalsa.com

Europe

Munich, Germany
 Tel: +49 8142-46770
sales.europe@teledynedalsa.com

Asia Pacific

Tokyo, Japan
 +81 3-5960-6353
sales.asia@teledynedalsa.com

TeledyneDALSA is an international leader in digital imaging and semiconductors and has its corporate offices in Waterloo, Ontario, Canada.

