

# PRECISION Cable Assemblies

2009 Edition

Analog  
Page 4

Camera Link  
Page 15

Gig E  
Page 32

IEEE1394  
Page 35

USB  
Page 44

Remote Head Cables  
Page 46

Power Supplies  
Page 47

Custom Assemblies  
Page 52

Index  
Page 62



**Intercon 1**  
A Division of Nortech Systems

# CONTENTS

<u>PART NUMBER</u>	<u>PAGE</u>	<u>PART NUMBER</u>	<u>PAGE</u>
<a href="#"><u>ABOUT US 1</u></a>	2	<a href="#"><u>POCLP*-xx-P</u></a>	28
<a href="#"><u>ABOUT US 2</u></a>	3	<a href="#"><u>POCLP-xx-PL</u></a>	29
<a href="#"><u>BVCP-xx-P</u></a>	4	<a href="#"><u>POMCLP-xx-P</u></a>	30
<a href="#"><u>SVCP-xx-P</u></a>	5	<a href="#"><u>POMCLP-xx-MP</u></a>	31
<a href="#"><u>SVCP*-xx-P</u></a>	6	<a href="#"><u>F-GEVPT-xx-P</u></a>	32
<a href="#"><u>MCS-xx-P</u></a>	7	<a href="#"><u>F-GEVVPT-xx-P</u></a>	33
<a href="#"><u>MVCP-xx-S</u></a>	8	<a href="#"><u>F-GEVP-xx-P</u></a>	34
<a href="#"><u>PVCS-xx-P</u></a>	9	<a href="#"><u>MIDAP-xx-PA</u></a>	35
<a href="#"><u>VCP-xx-S</u></a>	10	<a href="#"><u>MIDAP-xx-PB</u></a>	36
<a href="#"><u>VCS*-xx-P</u></a>	11	<a href="#"><u>MIDBP-xx-PB</u></a>	37
<a href="#"><u>VCS*2-xx-P</u></a>	12	<a href="#"><u>IF-MIDAPC-xx-PAC</u></a>	38
<a href="#"><u>VCXS-xx-PJB</u></a>	13	<a href="#"><u>IF-MIDAPT-xx-PAT</u></a>	39
<a href="#"><u>VCS-xx-B*</u></a>	14	<a href="#"><u>IF-MIDAP-xx-PA</u></a>	40
<a href="#"><u>CLCP-xx-P</u></a>	15	<a href="#"><u>F-FWBPT-xx-PA6</u></a>	41
<a href="#"><u>CLCP*-xx-P</u></a>	16	<a href="#"><u>F-FWBPT-xx-PB</u></a>	42
<a href="#"><u>CLCP-xx-PLx</u></a>	17	<a href="#"><u>F-FWBPT-xx-PBT</u></a>	43
<a href="#"><u>CLCP-xx-R</u></a>	18	<a href="#"><u>IF-B2PA-xx-PA</u></a>	44
<a href="#"><u>IF-CLCP-xx-P</u></a>	19	<a href="#"><u>GPIO-xx-PS</u></a>	45
<a href="#"><u>CLFP*-xx-R</u></a>	20	<a href="#"><u>RHC*P-**-P</u></a>	46
<a href="#"><u>CLCP3-xx-P3</u></a>	21	<a href="#"><u>WIPS-xxx-xx</u></a>	47
<a href="#"><u>CLOL-xxx*</u></a>	22	<a href="#"><u>PSI-xxx-xx</u></a>	48
<a href="#"><u>ECLP-xx-P</u></a>	23	<a href="#"><u>DPS-xxx-xx</u></a>	49
<a href="#"><u>MCLCP-xx-MP</u></a>	24	<a href="#"><u>IPS-xxx-xx</u></a>	50
<a href="#"><u>MCLCP-xx-P</u></a>	25	<a href="#"><u>Termination options</u></a>	51
<a href="#"><u>MCLCP*-xx-MP</u></a>	26	<a href="#"><u>Custom Capabilities</u></a>	52
<a href="#"><u>POCL-xx-P</u></a>	27		

## Reference Information

<a href="#"><u>Cable Guide</u></a>	54	<a href="#"><u>Cable Track Installation</u></a>	60
<a href="#"><u>Fire/Flame Tests and Ratings</u></a>	56	<a href="#"><u>Index</u></a>	
<a href="#"><u>Flex Testing</u></a>	57		

# About Us

## Intercon 1, a Division of Nortech Systems

Intercon 1, a division of Nortech Systems specializes in machine vision technology and is the premier producer of camera cable and assemblies in the United States. Since 1988 it has led the market in serving machine vision customers providing sophisticated engineering, specialized tools, and methodologies to support groundbreaking vision technology. By helping to develop critical commercial standards it has also remained a conceptual leader within its industry.

Augusta, WI: Nortech's Augusta facility is the manufacturing location for the majority of Intercon 1 products. The Augusta operation builds a wide array of wire and cable assemblies in volumes as small as one and offers rapid response times to satisfy the demands of its customers.



Fairmont and Blue Earth, Mn: Nortech's Aerospace Systems contributes 40 years of specialized experience in Military & Defense projects to Nortech's range of capabilities. Aerospace Systems manufactures military cable assemblies, largely for communications, ground support, testing and training applications.

**Custom variations available. Please contact customer service for additional information.**  
**Intercon 1** A Division of Nortech Systems, Inc. - 7746 Goedderz Road - Baxter, MN USA 56425  
P 218.828.3157 - Toll Free in US 800.237.9576 - FAX 218.828.1096 - [intercon@nortechsys.com](mailto:intercon@nortechsys.com)

# About Us

## Intercon 1, a Division of Nortech Systems

Nortech Systems is a full-service EMS provider of wire and cable assemblies, printed circuit board assemblies, diagnostic repair and integration services including, higher-level box builds for a wide range of industries. Markets served include medical, automotive, aerospace, computer peripheral, commercial, telecom, government and consumer. Nortech Systems has a range of specialized, high-tech facilities used for customized design, manufacture, testing and repair of its solutions.



Bemidji, Mn: Nortech Systems Bemidji specializes in complex wire harness and cable assemblies. They are a provider of innovative ideas and solutions and offer a full breadth of services. The Bemidji, MN operation has experience building applications in a broad range of industries including medical and industrial markets.

Merrifield, MN and Garner, IA: From the design phase through order fulfillment we specialize in printed circuit card assembly, final box assembly, and a full suite of test services for a diverse customer base. Our capabilities include fully automated SMT and PTH, semi automated through hole, and special lines using both technologies. We have a broad range of experience building applications in various industries including aerospace / defense, agriculture, oil / gas as well as medical and industrial markets.



Monterey, Mexico: This low cost alternative for high volume cable assemblies allows Nortech Systems the versatility needed to offer competitive solutions in a global market. This manufacturing location works hand in hand with our Bemidji and Augusta factories.

**Custom variations available. Please contact customer service for additional information.**  
**Intercon 1** A Division of Nortech Systems, Inc. - 7746 Goedderz Road - Baxter, MN USA 56425  
P 218.828.3157 - Toll Free in US 800.237.9576 - FAX 218.828.1096 - [intercon@nortechsys.com](mailto:intercon@nortechsys.com)

# Analog Video

## BNC Video Cable – BVCP-xx-P

### Product Outline

This high performance 75 Ohm BNC cable uses a robust RG59, controlled impedance cable to provide quality video images even at greater distances.

Overmolding provides superior strain relief and minimizes shorts and stress at the terminations through repeated installations or motion and vibration.

Assemblies are also available with a mini coax, RG174, or with multiple BNC breakouts for carrying full RGBS signals in one assembly. Please contact customer service for details.



### Main Product Specifications

#### Features

- Non contaminating PVC jacket
- Rugged high performance cable
- 75 Ohm signal +/- 3 Ohms
- Overmolded connectors

#### Cable Specifications

Cable Specifications	
Overall Diameter	.270 Inches
Max Temperature	80 Degrees C
Jacket Color	Black
UL/CSA Rated	Yes
Min. Bend Radius	4.05 Inches
Flame Rating	VW-1

#### Primary Components

Primary Components	
Cable	4 Coax conductors, 4 Discrete wires
Connector A	80 Degrees C
Connector B	Black
UL/CSA Rated	Yes
Min. Bend Radius	4.05 Inches

### Ordering Information

#### Length

Order Number	Length		Description
	Meters	Feet	
VCP-1.0-S	1.0	3.28	Analog CCXC Style
VCP-2.0-S	2.0	6.58	Analog CCXC Style
VCP-3.0-S	3.0	9.84	Analog CCXC Style
VCP-5.0-S	5.0	16.94	Analog CCXC Style
VCP-10-S	10	32.81	Analog CCXC Style

[Return to Top](#)

**Custom variations available. Please contact customer service for additional information.**

**Intercon 1** A Division of Nortech Systems, Inc. - 7746 Goedderz Road - Baxter, MN USA 56425  
P 218.828.3157 - Toll Free in US 800.237.9576 - FAX 218.828.1096 - [intercon@nortechsys.com](mailto:intercon@nortechsys.com)

# Analog Video

## High Performance S-Video – SVCP-xx-P

### Product Outline

This dual, side by side, 75 Ohm controlled impedance coaxial cable assemblies provides accurate signal transmission with a tolerance of +/- 4 ohms to ensure high-quality video images.

The flat cable design allows for both pliability and high flex life.

Overmolded connectors increase the rugged durability with superior strain relief.

Assemblies are also available with right angle overmolds.



### Main Product Specifications

#### Features

- Industrial overmolded interfaces
- Flexible YC cable
- Precision 75 Ohm video conductors
- Right angle interfaces available

#### Cable Specifications

Cable Specifications	
Overall Diameter	.270 Inches
Max Temperature	80 Degrees C
Jacket Color	Black
UL/CSA Rated	Yes
Min. Bend Radius	4.05 Inches
Flame Rating	VW-1

#### Primary Components

Primary Components	
Cable	4 Coax conductors, 4 Discrete wires
Connector A	80 Degrees C
Connector B	Black
UL/CSA Rated	Yes
Min. Bend Radius	4.05 Inches

### Ordering Information

#### Length

Order Number	Length		Description
	Meters	Feet	
SVCP-0.31-P	0.31	1	High Performance Flat S-Video
SVCP-0.92-P	0.92	3	High Performance Flat S-Video
SVCP-1.8-P	1.8	6	High Performance Flat S-Video
SVCP-3.05-P	3.05	10	High Performance Flat S-Video
SVCP-4.6-P	4.6	15	High Performance Flat S-Video

[Return to Top](#)

**Custom variations available. Please contact customer service for additional information.**

**Intercon 1** A Division of Nortech Systems, Inc. - 7746 Goedderz Road - Baxter, MN USA 56425  
P 218.828.3157 - Toll Free in US 800.237.9576 - FAX 218.828.1096 - [intercon@nortechsys.com](mailto:intercon@nortechsys.com)

# Analog Video

## High Performance Right Angle S-Video – SVCP\*-xx-P

### Product Outline

This dual, side by side, 75 Ohm controlled impedance coaxial cable provides accurate signal transmission with a tolerance of +/- 4 ohms to ensure high-quality video images.

The flat cable design allows for both pliability and high flex life.

Overmolded connectors increase the rugged durability with superior strain relief.

The unique right angle overmold reduces stress and increases durability in space restricted applications.



### Main Product Specifications

#### Features

- Industrial overmolded interfaces
- Flexible YC cable
- Precision 75 Ohm video conductors
- Right angles available in Up, Down, Left, or Right

#### Cable Specifications

Cable Specifications	
Overall Diameter	.270 Inches
Max Temperature	80 Degrees C
Jacket Color	Black
UL/CSA Rated	Yes
Min. Bend Radius	4.05 Inches
Flame Rating	VW-1

#### Primary Components

Primary Components	
Cable	4 Coax conductors, 4 Discrete wires
Connector A	80 Degrees C
Connector B	Black
UL/CSA Rated	Yes
Min. Bend Radius	4.05 Inches

### Ordering Information

#### Length

Order Number	Length		Description
	Meters	Feet	
SVCP*-0.31-P	0.31	1	High Performance Flat S-Video RA
SVCP*-0.92-P	0.92	3	High Performance Flat S-Video RA
SVCP*-1.8-P	1.8	6	High Performance Flat S-Video RA
SVCP*-3.05-P	3.05	10	High Performance Flat S-Video RA
SVCP*-4.6-P	4.6	15	High Performance Flat S-Video RA

Please replace \* with "U" for up, "D" for down, "R" for right, or "L" for left.

[Return to Top](#)

**Custom variations available. Please contact customer service for additional information.**

**Intercon 1** A Division of Nortech Systems, Inc. - 7746 Goedderz Road - Baxter, MN USA 56425  
P 218.828.3157 - Toll Free in US 800.237.9576 - FAX 218.828.1096 - [intercon@nortechsys.com](mailto:intercon@nortechsys.com)

# Analog Video

## CCXC Style Cable – MCS-xx-P

### Product Outline

This cable assembly was designed for use with Sony medical cameras. They are capable of transmitting high quality video signals through tough, demanding environments where failures are unacceptable.

Rugged TPE overmolding provides the best strain relief to ensure continued performance through repeated motion, vibration, or installations.

This assembly is available in several cable options as well as right angle overmolding. Please contact customer service.



### Main Product Specifications

#### Features

- Overmolded strain relief
- 75 Ohm video signals
- High Flex and Teflon versions are available
- Right angle overmolds are available

#### Cable Specifications

Cable Specifications	
Overall Diameter	.270 Inches
Max Temperature	80 Degrees C
Jacket Color	Black
UL/CSA Rated	Yes
Min. Bend Radius	4.05 Inches
Flame Rating	VW-1

#### Primary Components

Primary Components	
Cable	4 Coax conductors, 4 Discrete wires
Connector A	80 Degrees C
Connector B	Black
UL/CSA Rated	Yes
Min. Bend Radius	4.05 Inches

### Ordering Information

#### Length

Order Number	Length		Description
	Meters	Feet	
MCS-2.0-P	2.0	6.56	Analog CCXC Style
MCS-3.0-P	3.0	9.84	Analog CCXC Style
MCS-5.0-P	5.0	16.4	Analog CCXC Style
MCS-10-P	10	32.8	Analog CCXC Style
MCS-15-P	15	49.21	Analog CCXC Style

Custom variations are available. Please contact customer service for additional information.

[Return to Top](#)

**Custom variations available. Please contact customer service for additional information.**

**Intercon 1** A Division of Nortech Systems, Inc. - 7746 Goedderz Road - Baxter, MN USA 56425  
P 218.828.3157 - Toll Free in US 800.237.9576 - FAX 218.828.1096 - [intercon@nortechsys.com](mailto:intercon@nortechsys.com)



# Analog Video

## High Flex CCXC Style Cable – MVCP-xx-S

### Product Outline

These high flex cable assemblies offer an industrial solution for motion applications requiring a robust CCXC style cable. The combination of a high flex cable and overmolded interfaces offer a durable solution designed to sustain abuse while transmitting high quality 75 Ohm video signals.

These assemblies can be produced in a variety of options including standard and Teflon cable types to best fit your application.

Right angle and low profile right angle assemblies are also available.



### Main Product Specifications

#### Features

- High Flex cable
- Overmolded connectors
- Controlled Impedance
- Superior long length performance
- RoHS Compliant versions are available
- Standard lengths are available
- Right angle molds are available

#### Cable Specifications

Cable Specifications	
Overall Diameter	.270 Inches
Max Temperature	80 Degrees C
Jacket Color	Black
UL/CSA Rated	Yes
Min. Bend Radius	4.05 Inches
Flame Rating	VW-1

#### Primary Components

Primary Components	
Cable	4 Coax conductors, 4 Discrete wires
Connector A	80 Degrees C
Connector B	Black
UL/CSA Rated	Yes
Min. Bend Radius	4.05 Inches

### Ordering Information

#### Length

Order Number	Length		Description
	Meters	Feet	
MVCP-1.0-S	1.0	3.28	High Flex Analog CCXC Style
MVCP-2.0-S	2.0	6.58	High Flex Analog CCXC Style
MVCP-3.0-S	3.0	9.84	High Flex Analog CCXC Style
MVCP-5.0-S	5.0	16.94	High Flex Analog CCXC Style
MVCP-10-S	10	32.81	High Flex Analog CCXC Style

Custom variations are available. Please contact customer service for additional information.

[Return to Top](#)

**Custom variations available. Please contact customer service for additional information.**

**Intercon 1** A Division of Nortech Systems, Inc. - 7746 Goedderz Road - Baxter, MN USA 56425  
P 218.828.3157 - Toll Free in US 800.237.9576 - FAX 218.828.1096 - [intercon@nortechsys.com](mailto:intercon@nortechsys.com)

# Analog Video

## CCXC Style Video Cable – PVCS-xx-P

### Product Outline

This CCXC style cable was designed for use with Pulnix cameras. Utilizing our standard CCXC style bulk cable, 89238A, these dependable assemblies have successfully transmitted high quality video images at lengths up to 65 meters.

With an exclusive industrial overmold from Intercon 1, these assemblies are a proven robust solution.

Assemblies are also available in high flex and Teflon versions.



### Main Product Specifications

#### Features

- Overmold connectors
- 75 Ohm video conductors
- Exceptional quality over long distances
- RoHS Compliant versions are available
- High flex versions are available
- Right angle overmolds are available

#### Cable Specifications

Cable Specifications	
Overall Diameter	.270 Inches
Max Temperature	80 Degrees C
Jacket Color	Black
UL/CSA Rated	Yes
Min. Bend Radius	4.05 Inches
Flame Rating	VW-1

#### Primary Components

Primary Components	
Cable	4 Coax conductors, 4 Discrete wires
Connector A	12 Pos Circular Plug W / Sockets
Connector B	12 Pos Circular Plug W / Pins

### Ordering Information

Order Number	Length		Description
	Meters	Feet	
PVCS-2.0-P	2.0	6.5	Analog CCXC Style
PVCS-3.0-P	3.0	9.8	Analog CCXC Style
PVCS-5.0-P	5.0	16.4	Analog CCXC Style
PVCS-10-P	10	32.8	Analog CCXC Style
PVCS-15-P	15	49.2	Analog CCXC Style

Custom variations are available. Please contact customer service for additional information.

[Return to Top](#)

**Custom variations available. Please contact customer service for additional information.**

**Intercon 1** A Division of Nortech Systems, Inc. - 7746 Goedderz Road - Baxter, MN USA 56425  
P 218.828.3157 - Toll Free in US 800.237.9576 - FAX 218.828.1096 - [intercon@nortechsys.com](mailto:intercon@nortechsys.com)

# Analog Video

## CCXC Style – VCP-xx-S

### Product Outline

These robust camera interface assemblies incorporate a controlled impedance 75 Ohm video cable, precision assembly techniques, and resilient industrial grade TPE overmolding to provide the ultimate in dependable CCXC connections.

These assemblies can be produced in a variety of options including high flex and Teflon cable types to best fit your application.

Right angle and low profile right angle assemblies are also available.



### Main Product Specifications

#### Features

- Overmolded connectors
- Controlled Impedance 75 Ohm video conductors
- Superior long length performance
- RoHS Compliant versions are available
- Standard lengths are available

#### Cable Specifications

Cable Specifications	
Overall Diameter	.270 Inches
Max Temperature	80 Degrees C
Jacket Color	Black
UL/CSA Rated	Yes
Min. Bend Radius	4.05 Inches
Flame Rating	VW-1

#### Primary Components

Primary Components	
Cable	4 Coax conductors, 4 Discrete wires
Connector A	12 Pos Circular Plug W / Sockets
Connector B	12 Pos Circular Plug W / Pins

### Ordering Information

Order Number	Length		Description
	Meters	Feet	
VCP-1.0-S	1.0	3.28	Analog CCXC Style
VCP-2.0-S	2.0	6.58	Analog CCXC Style
VCP-3.0-S	3.0	9.84	Analog CCXC Style
VCP-5.0-S	5.0	16.94	Analog CCXC Style
VCP-10-S	10	32.81	Analog CCXC Style

Custom variations are available. Please contact customer service for additional information.

[Return to Top](#)

**Custom variations available. Please contact customer service for additional information.**  
**Intercon 1** A Division of Nortech Systems, Inc. - 7746 Goedderz Road - Baxter, MN USA 56425  
 P 218.828.3157 - Toll Free in US 800.237.9576 - FAX 218.828.1096 - [intercon@nortechsys.com](mailto:intercon@nortechsys.com)

# Analog Video

## Right Angle CCXC Style – VCS\*-xx-P

### Product Outline

These industrial CCXC style assemblies offer a unique right angle overmold for applications requiring an immediate turn behind the interface. The common configuration consists of a right angle on the camera (socket) end and an overmolded straight connector on the equipment end. However both connectors are available with a right angle.

These assemblies can be produced in a variety of options including high flex and Teflon cable types to best fit your application.

Orientations are available in up, down, left, and right.



### Main Product Specifications

#### Features

- Right angle overmolded connectors
- Controlled Impedance 75 Ohm video conductors
- Superior long length performance
- RoHS Compliant versions are available

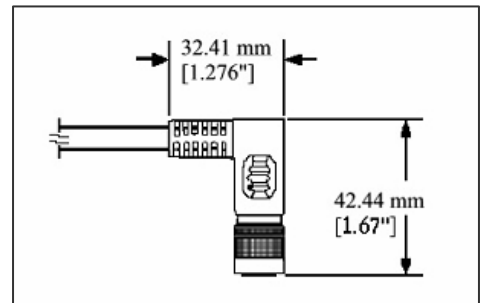

#### Cable Specifications

Cable Specifications	
Overall Diameter	.270 Inches
Max Temperature	80 Degrees C
Jacket Color	Black
UL/CSA Rated	Yes
Min. Bend Radius	4.05 Inches
Flame Rating	VW-1

#### Primary Components

Primary Components	
Cable	4 Coax conductors, 4 Discrete wires
Connector A	12 Pos Circular Plug W / Sockets
Connector B	12 Pos Circular Plug W / Pins

### Ordering Information

Order Number	Length		Description
	Meters	Feet	
VCS*-1.0-P	1.0	3.28	Right Angle Analog CCXC Style
VCS*-2.0-P	2.0	6.58	Right Angle Analog CCXC Style
VCS*-3.0-P	3.0	9.84	Right Angle Analog CCXC Style
VCS*-5.0-P	5.0	16.94	Right Angle Analog CCXC Style
VCS*-10-P	10	32.81	Right Angle Analog CCXC Style

Please replace \* with "U" for up, "D" for down, "R" for right, or "L" for left.

[Return to Top](#)

**Custom variations available. Please contact customer service for additional information.**

**Intercon 1** A Division of Nortech Systems, Inc. - 7746 Goedderz Road - Baxter, MN USA 56425  
P 218.828.3157 - Toll Free in US 800.237.9576 - FAX 218.828.1096 - [intercon@nortechsys.com](mailto:intercon@nortechsys.com)

# Analog Video

## Low Profile Right Angle CCXC Style – VCS\*2-xx-P

### Product Outline

These industrial CCXC style assemblies offer a unique low profile right angle overmold for applications requiring an immediate turn behind the interface. The low profile overmold allows for a robust solution for space restricted applications eliminating the need for tight bends which can lead to failure.

These assemblies can be produced in a variety of options including high flex, and Teflon cable types to best fit your application.

Orientations are available in up, down, left, and right.



### Main Product Specifications

#### Features

- Low profile right angle overmolded connectors
- Controlled Impedance 75 Ohm video conductors
- Superior long length performance
- RoHS Compliant versions are available

#### Cable Specifications

Cable Specifications	
Overall Diameter	.270 Inches
Max Temperature	80 Degrees C
Jacket Color	Black
UL/CSA Rated	Yes
Min. Bend Radius	4.05 Inches
Flame Rating	VW-1

#### Primary Components

Primary Components	
Cable	4 Coax conductors, 4 Discrete wires
Connector A	12 Pos Circular Plug W / Sockets
Connector B	12 Pos Circular Plug W / Pins

### Ordering Information

Order Number	Length		Description
	Meters	Feet	
VCS*2-1.0-P	1.0	3.28	Analog CCXC Style
VC S*2-2.0-P	2.0	6.58	Analog CCXC Style
VC S*2-3.0-P	3.0	9.84	Analog CCXC Style
VC S*2-5.0-P	5.0	16.94	Analog CCXC Style
VC S*2-10-P	10	32.81	Analog CCXC Style

Please replace \* with "U" for up, "D" for down, "R" for right, or "L" for left.

[Return to Top](#)

**Custom variations available. Please contact customer service for additional information.**  
**Intercon 1** A Division of Nortech Systems, Inc. - 7746 Goedderz Road - Baxter, MN USA 56425  
 P 218.828.3157 - Toll Free in US 800.237.9576 - FAX 218.828.1096 - [intercon@nortechsys.com](mailto:intercon@nortechsys.com)

## CCXC Style Extension Cable Flange Mount – VCXS-xx-PJB

### Product Outline

These assemblies allow the mounting of a 12 position circular connector on a panel from either the front or from the inside of the equipment. The bracket is mountable on either the socket end or the pin end of the cable depending upon your specific needs.

Assemblies are also available with a mini coax, RG174, or with multiple BNC breakouts for carrying full RGBS signals in one assembly. Please contact customer service for details.

Intercon 1 quality is maintained with the use of our high performance 75 ohm CCXC cable and custom overmolded connectors. Assemblies are available without the bracket and with high flex or Teflon cables.



### Main Product Specifications

#### Features

- Bracket for easy mounting
- Overmolded connectors
- RoHS Compliant versions are available
- Superior long length performance

#### Cable Specifications

Cable Specifications	
Overall Diameter	.270 Inches
Max Temperature	80 Degrees C
Jacket Color	Black
UL/CSA Rated	Yes
Min. Bend Radius	4.05 Inches
Flame Rating	VW-1

#### Primary Components

Primary Components	
Cable	4 Coax conductors, 4 Discrete wires
Connector A	12 Pos Circular Plug
Connector B	12 Pos Circular Jack

### Ordering Information

#### Length

Order Number	Length		Description
	Meters	Feet	
VCP-1.0-S	1.0	3.28	Analog CCXC Style
VCP-2.0-S	2.0	6.58	Analog CCXC Style
VCP-3.0-S	3.0	9.84	Analog CCXC Style
VCP-5.0-S	5.0	16.94	Analog CCXC Style
VCP-10-S	10	32.81	Analog CCXC Style

Custom variations are available. Please contact customer service for additional information.

[Return to Top](#)

**Custom variations available. Please contact customer service for additional information.**

**Intercon 1** A Division of Nortech Systems, Inc. - 7746 Goedderz Road - Baxter, MN USA 56425  
P 218.828.3157 - Toll Free in US 800.237.9576 - FAX 218.828.1096 - [intercon@nortechsys.com](mailto:intercon@nortechsys.com)

# Analog Video

## CCXC Style – VCS-xx-B\*

### Product Outline

This video breakout cable consists of a standard 12 pos circular connector with BNC video output connectors, DC power leads, and chassis ground.

In addition to the overmolded connectors, the breakout junction is also overmolded. This provides both a clean, professional appearance as well as eliminates the potential failure point with increased strain relief.

Configurations are available with 1-5 BNC's, S-Video, or RCA breakouts. High flex, double shielded, and Teflon versions are available.

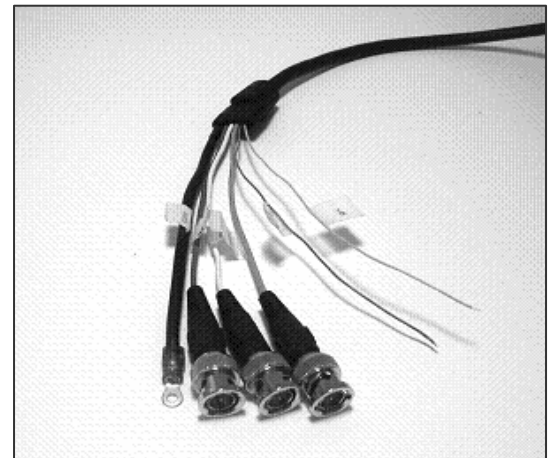

### Main Product Specifications

#### Features

- Overmolded connectors
- Overmolded breakouts
- Multiple breakout variations
- 75 Ohm video
- Multiple jacketing options to fit your application

#### Cable Specifications

Cable Specifications	
Overall Diameter	.270 Inches
Max Temperature	80 Degrees C
Jacket Color	Black
UL/CSA Rated	Yes
Min. Bend Radius	4.05 Inches
Flame Rating	VW-1

#### Primary Components

Primary Components	
Cable	75 Ohm coax , 24 AWG discrete wires
Connector A	12 Position Circular
Connector B	75 Ohm BNC

### Ordering Information

#### Length

Order Number	Length		Description
	Meters	Feet	
VCS-XX-B1			12 Pos. Breakout to 1 BNC, PWR
VCS-XX-B2			12 Pos. Breakout to 2 BNC, PWR
VCS-XX-B3			12 Pos. Breakout to 3 BNC, PWR
VCS-XX-B4			12 Pos. Breakout to 4 BNC, PWR
VCS-XX-B5			12 Pos. Breakout to 5 BNC, PWR

XX- is replaced by the length in Meters.

Custom variations are available. Please contact customer service for additional information.

[Return to Top](#)

**Custom variations available. Please contact customer service for additional information.**

**Intercon 1** A Division of Nortech Systems, Inc. - 7746 Goedderz Road - Baxter, MN USA 56425  
P 218.828.3157 - Toll Free in US 800.237.9576 - FAX 218.828.1096 - [intercon@nortechsys.com](mailto:intercon@nortechsys.com)

## Certified High Flex Camera Link – Straight – CLCP-xx-P

### Product Outline

These molded InterFlex assemblies are Certified to Camera Link Committee Standards.

By combining the most advanced materials and sophisticated building techniques, Intercon 1 provides the most robust industrial assemblies available. These assemblies are designed to function within a broad range of temperature and environmental conditions and may be used in either static or flex applications.

Intercon 1 high-flex cable construction adheres with the Camera Link specifications and performs past 1 million flex cycles.



### Main Product Specifications

#### Features

- Overmolded
- Thumbscrew locking
- Designed to surpass 1 million flex cycles
- Camera Link Certified



#### Cable Specifications

Cable Specifications	
Overall Diameter	.375 Inches
Max Temperature	80 Degrees C
Jacket Color	Black
UL/CSA Rated	Yes
Min. Bend Radius	3.75 Inches
Flame Rating	FT-1

#### Primary Components

Primary Components	
Cable	11 Individually Shielded Twisted Pairs
Connector A	26 Pos MDR
Connector B	26 Pos MDR

### Ordering Information

Order Number	Description
CLCP-xx-P	High Flex Camera Link

Replace xx with length in meters  
For cables longer than 10 meters contact customer service

[Return to Top](#)

**Custom variations available. Please contact customer service for additional information.**  
**Intercon 1** A Division of Nortech Systems, Inc. - 7746 Goedderz Road - Baxter, MN USA 56425  
 P 218.828.3157 - Toll Free in US 800.237.9576 - FAX 218.828.1096 - [intercon@nortechsys.com](mailto:intercon@nortechsys.com)



## High Flex Right Angle Certified Camera Link – CLCP\*-xx-P

### Product Outline

Intercon 1's high performance right angle Camera Link cable increases versatility and resilience in restricted space applications.

The unique right angle overmolding available in up, down, left and right orientations allows for immediate turns behind the interface that are specific to your application needs eliminating the need for minimum bend radius concerns.

The high flex cable construction adheres to the Camera Link specifications and performs with a projected flex life of over 1 million flex cycles. Independent testing of the assembly has surpassed 5 million flex cycles.



### Main Product Specifications

#### Features

- Robust high flex cable
- 360 degree shielding
- Durable overmolding
- Right angle interface in up, down, left, and right configurations
- RoHS Compliant



#### Cable Specifications

Cable Specifications	
Overall Diameter	.375 Inches
Max Temperature	80 Degrees C
Jacket Color	Black
UL/CSA Rated	Yes
Min. Bend Radius	3.75 Inches
Flame Rating	FT-1

#### Primary Components

Primary Components	
Cable	11 Individually Shielded Twisted Pairs
Connector A	26 Pos MDR
Connector B	26 Pos MDR

### Ordering Information

Order Number	Description
CLCP*-xx-P	High Flex Camera Link

Replace xx with length in meters  
 Replace \* with "U" for up, "D" for down, "R" for right or "L" for left  
 For cables longer than 10 meters contact customer service

[Return to Top](#)

**Custom variations available. Please contact customer service for additional information.**  
**Intercon 1** A Division of Nortech Systems, Inc. - 7746 Goedderz Road - Baxter, MN USA 56425  
 P 218.828.3157 - Toll Free in US 800.237.9576 - FAX 218.828.1096 - [intercon@nortechsys.com](mailto:intercon@nortechsys.com)

## Certified Low Profile Right Angle Camera Link – CLCP-xx-PLx

### Product Outline

This high flex Camera Link cable features a low profile right angle overmold for superior strain relief in restricted space applications.

Fabricated with Intercon 1 high performance Camera Link cable, these assemblies offer the same dependability and robustness of our straight configurations in a unique design that allows for immediate turns and offers increased versatility. The height of the overmold is a small .67 inches, allowing for use in the most restricted spaces.

Configurations are available with the right angle orientated up or down



### Main Product Specifications

#### Features

- Low Profile right angle overmolded strain relief
- Thumbscrew locking
- High Flex cable design
- Certified Camera Link product
- RoHS Compliant

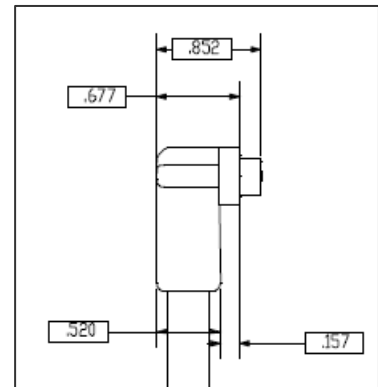

Cable Specifications	
Overall Diameter	.375 Inches
Max Temperature	80 Degrees C
Jacket Color	Black
UL/CSA Rated	Yes
Min. Bend Radius	3.75 Inches
Flame Rating	FT-1

Primary Components	
Cable	11 Individually Shielded Twisted Pairs
Connector A	26 Pos MDR
Connector B	26 Pos MDR

### Ordering Information

Order Number	Description
CLCP-xx-PLx	High Flex Camera Link

Replace xx with length in meters  
 Replace \* with "U" for up, "D" for down  
 For cables longer than 10 meters contact customer service

[Return to Top](#)

**Custom variations available. Please contact customer service for additional information.**  
**Intercon 1** A Division of Nortech Systems, Inc. - 7746 Goedderz Road - Baxter, MN USA 56425  
 P 218.828.3157 - Toll Free in US 800.237.9576 - FAX 218.828.1096 - [intercon@nortechsys.com](mailto:intercon@nortechsys.com)

## High Flex Camera Link Extension Cables – Straight– CLCP-xx-R

### Product Outline

This High Flex extension cable offers system versatility and convenience when required to extend your current cable length.

Both the plug and the receptacle connectors feature durable overmolded strain reliefs. The receptacle end is completed with 4/40 jacknuts to ensure locking and proper, constant connection through motion and vibration.

Right angle and low profile right angle assemblies are also available in the extension format. Please contact customer service.



### Main Product Specifications

#### Features

- Overmolded
- Thumbscrew locking
- Designed to surpass 1 million flex cycles
- RoHS Compliant

Cable Specifications	
Overall Diameter	.375 Inches
Max Temperature	80 Degrees C
Jacket Color	Black
UL/CSA Rated	Yes
Min. Bend Radius	3.75 Inches
Flame Rating	FT-1

Primary Components	
Cable	11 Individually Shielded Twisted Pairs
Connector A	26 Pos MDR Plug
Connector B	26 Pos MDR Receptacle

### Ordering Information

Order Number	Description
CLCP-xx-R	High Flex Camera Link

Replace xx with length in meters  
 Also available in RA configuration for male side  
 For cables longer than 10 meters contact customer service

[Return to Top](#)

**Custom variations available. Please contact customer service for additional information.**  
**Intercon 1** A Division of Nortech Systems, Inc. - 7746 Goedderz Road - Baxter, MN USA 56425  
 P 218.828.3157 - Toll Free in US 800.237.9576 - FAX 218.828.1096 - [intercon@nortechsys.com](mailto:intercon@nortechsys.com)

## Infini-Flex Camera Link – IF-CLCP-xx-P



### Product Outline

Designed specifically for cable carrier systems these High Flex cable assemblies provide the ultimate in dependability, electrical and mechanical performance through millions of flex cycles.

Featuring unique characteristics such as low particulation and a tight bend radius, this cable is engineered for a variety of environments.

Available as standard products or in custom configurations.



### Main Product Specifications

#### Features

- Overmolded interface with thumbscrew locking
- Low particulation for clean room applications
- High Flex cable designed to surpass 5 million flexes
- RoHS Compliant
- Unique Quad construction

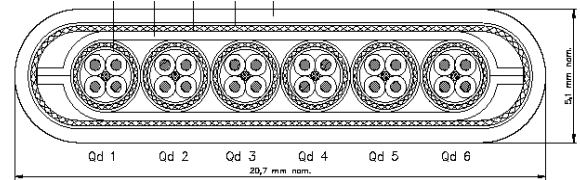

Cable Specifications	
Overall Diameter	5.1mm x 20.7mm
Jacket Color	White
UL/CSA Rated	21090
Min. Bend Radius	50mm
Flame Rating	Retardant

Primary Components	
Cable	Quad Construction
Connector A	26 Pos MDR Plug
Connector B	26 Pos MDR Plug

### Ordering Information

Order Number	Description
IF-CLCP-xx-P	High Flex Camera Link

Replace xx with length in meters  
For cables longer than 10 meters contact customer service

[Return to Top](#)

**Custom variations available. Please contact customer service for additional information.**  
**Intercon 1** A Division of Nortech Systems, Inc. - 7746 Goedderz Road - Baxter, MN USA 56425  
 P 218.828.3157 - Toll Free in US 800.237.9576 - FAX 218.828.1096 - [intercon@nortechsys.com](mailto:intercon@nortechsys.com)

## Low Profile Right Angle Feed Thru Internal Assembly – CLFP\*-xx-R

### Product Outline

These overmolded low profile assemblies have been designed and tested for internal camera to panel use.

The unique 'feed thru' assembly design reduces the space needed behind the camera for mounting in tight spaces or inside cabinets. The standard 8 inch cable length is available from stock and is perfect for most applications. Stainless steel thumbscrews ensure positive retention between the connector and the camera.



### Main Product Specifications

#### Features

- Lowest profile right angle Camera Link available
- Overmolded plug interface
- Pliable ribbon style for flexibility
- Receptacle jacknuts for easy mounting
- RoHS Compliant

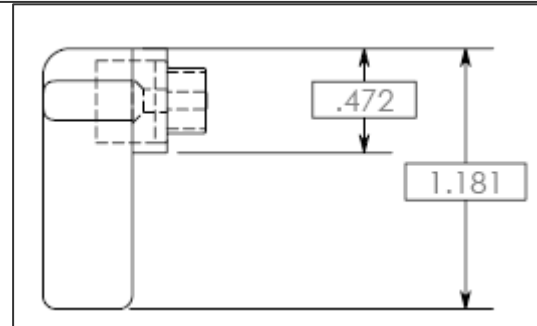
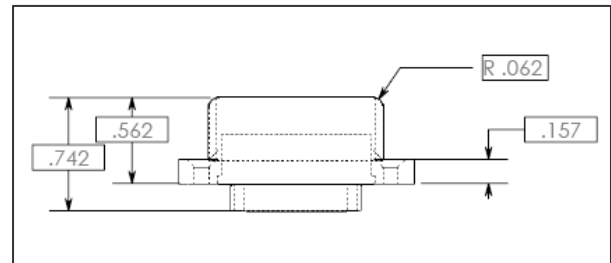

#### Primary Components

Primary Components	
Cable	Shielded Ribbon
Connector A	26 Pos MDR Plug
Connector B	26 Pos MDR Receptacle

### Ordering Information

Order Number	Length		Description
	Meters	Feet	
CLFPU-0.2-R	0.2	0.66	CL Feed Thru RA Up
CLFPD-0.2-R	0.2	0.66	CL Feed Thru RA Down
CLFPU-0.2-RE	0.2	0.66	CL Feed Thru RA Up w/Epoxy
CLFPD-0.2-RE	0.2	0.66	CL Feed Thru RA Down w/Epoxy

[Return to Top](#)

**Custom variations available. Please contact customer service for additional information.**  
**Intercon 1** A Division of Nortech Systems, Inc. - 7746 Goedderz Road - Baxter, MN USA 56425  
 P 218.828.3157 - Toll Free in US 800.237.9576 - FAX 218.828.1096 - [intercon@nortechsys.com](mailto:intercon@nortechsys.com)

## Certified High Flex Camera Link– Latch Style – CLCP3-xx-P3

### Product Outline

These high flex Camera Link cable assemblies are constructed utilizing a latching backshell.

The latch style locking offers a quicker connect/disconnect time than standard thumbscrews.

Cables are available with latches on both ends and with latches on one end and thumbscrews on the other.



### Main Product Specifications

#### Features

- Quick Latch style locking
- Designed to surpass 1 Million Flex Cycles
- RoHS Compliant
- Camera Link Certified



Cable Specifications	
Overall Diameter	.375 Inches
Max Temperature	80 Degrees C
Jacket Color	Black
UL/CSA Rated	Yes
Min. Bend Radius	3.75 Inches
Flame Rating	FT-1

Primary Components	
Cable	11 Individually Shielded Twisted Pairs
Connector A	26 Pos MDR
Connector B	26 Pos MDR

### Ordering Information

Order Number	Description
CLCP3-xx-P3	High Flex Camera Link

Replace xx with length in meters

For cables longer than 10 meters contact customer service

For latches on one end only remove "3" from the end of the part number

[Return to Top](#)

**Custom variations available. Please contact customer service for additional information.**  
**Intercon 1** A Division of Nortech Systems, Inc. - 7746 Goedderz Road - Baxter, MN USA 56425  
 P 218.828.3157 - Toll Free in US 800.237.9576 - FAX 218.828.1096 - [intercon@nortechsys.com](mailto:intercon@nortechsys.com)

## OptiLink – Fiber Optic Extension System – CLOL-xxx\*

### Product Outline

OptiLink is a fiber optic extension system that allows Camera Link signals to be passed beyond the standard's maximum lengths.

Lengths of up to 300 meters can be achieved with a standard fiber optic cable. With a special extended system, signals can be successfully transmitted up to 10 kilometers.

This allows for incredible versatility for unique applications.

A variety of fiber optic cables are available including standard, high flex and outdoor rated.



### Main Product Specifications

#### Features

- Extended length for Camera Link signals
- Multiple fiber optic variations
- Standard LC duplex connections
- Attached directly to camera and framegrabber
- Base, Medium, and Full Modes available

#### Primary Components

Primary Components	
Cable	Fiber Optic
Connector A	LC Duplex
Connector B	LC Duplex
Power Adapter	Wall Mount Transformer

### Ordering Information

Order Number	Description
CLOL-XXXS	OptiLink System with Standard LC Cable
CLOL-XXXI	OptiLink System with Rugged Outdoor LC Cable
CLOL-XXXH	OptiLink System with High Flex LC Cable

To insure proper configuration please provide camera and frame grabber model numbers at time of quote. Part numbers listed are for base mode. Medium and full mode configurations also available  
Please replace XX with the desired length in Meters

[Return to Top](#)

**Custom variations available. Please contact customer service for additional information.**  
**Intercon 1** A Division of Nortech Systems, Inc. - 7746 Goedderz Road - Baxter, MN USA 56425  
 P 218.828.3157 - Toll Free in US 800.237.9576 - FAX 218.828.1096 - [intercon@nortechsys.com](mailto:intercon@nortechsys.com)

## Economy Camera Link – ECLP-xx-P

### Product Outline

Designed as an alternative for static ( non-flexing ) applications, these low cost cables offer the dependability of Intercon 1 Camera Link at an economical price.

This series features overmolded connectors for high quality strain relief as well as thumbscrew locking.

Standard lengths of these assemblies are in stock and available to ship.



### Main Product Specifications

#### Features

- Low cost alternative to high flex assemblies
- Overmolded strain relief
- 4/40 Thumbscrews
- Assemblies available from stock.



#### Cable Specifications

Cable Specifications	
Overall Diameter	.352 Inches
Max Temperature	80 Degrees C
Jacket Color	Black
UL/CSA Rated	Yes
Min. Bend Radius	5.28 Inches
Flame Rating	vw-1

#### Primary Components

Primary Components	
Cable	11 Individually Shielded Twisted Pairs
Connector A	26 Pos MDR
Connector B	26 Pos MDR

### Ordering Information

Order Number	Length		Description
	Meters	Feet	
ECLP-1.0-P	1.0	3.28	Economy Camera Link
ECLP-2.0-P	2.0	6.56	Economy Camera Link
ECLP-3.0-P	3.0	9.84	Economy Camera Link
ECLP-4.0-P	4.0	14.76	Economy Camera Link
ECLP-5.0-P	5.0	16.4	Economy Camera Link

Additional lengths are available in stock. Please contact customer service for details.

[Return to Top](#)

**Custom variations available. Please contact customer service for additional information.**

**Intercon 1** A Division of Nortech Systems, Inc. - 7746 Goedderz Road - Baxter, MN USA 56425  
P 218.828.3157 - Toll Free in US 800.237.9576 - FAX 218.828.1096 - [intercon@nortechsys.com](mailto:intercon@nortechsys.com)



## Mini Camera Link – MCLCP-xx-MP

### Product Outline

Mini Camera Link offers a smaller interface without sacrificing performance and quality.

This high performance cable is capable of withstanding extreme outside stress such as flexing, high temperatures, outdoor elements, and electrical noise without exhibiting electrical degradation.

The rugged overmold offers additional benefits for added strain relief and durability under motion, installations, and vibration. The thumbscrews ensure proper mating and constant connectivity.



### Main Product Specifications

#### Features

- 1 million + flex life design
- Overmolded connectors
- Robust jacket capable of outdoor use
- 360 degree shielding
- RoHS Compliant
- Right angle configurations available



#### Cable Specifications

Cable Specifications	
Overall Diameter	.270 Inches
Max Temperature	80 Degrees C
Jacket Color	Black
UL/CSA Rated	Yes
Min. Bend Radius	2.70 Inches
Flame Rating	vw-1 / FT-1

#### Primary Components

Primary Components	
Cable	11 Individually Shielded Twisted Pairs
Connector A	26 Pos SDR (HDR)
Connector B	26 Pos SDR (HDR)

### Ordering Information

Order Number	Length		Description
	Meters	Feet	
MCLCP-1.0-MP	1.0	3.28	Mini CL to Mini CL High Flex
MCLCP-2.0-MP	2.0	6.56	Mini CL to Mini CL High Flex
MCLCP-3.0-MP	3.0	9.84	Mini CL to Mini CL High Flex
MCLCP-4.0-MP	4.0	14.76	Mini CL to Mini CL High Flex
MCLCP-5.0-MP	5.0	16.4	Mini CL to Mini CL High Flex

Custom variations are available. Please contact customer service for additional information.

[Return to Top](#)

**Custom variations available. Please contact customer service for additional information.**

**Intercon 1** A Division of Nortech Systems, Inc. - 7746 Goedderz Road - Baxter, MN USA 56425  
 P 218.828.3157 - Toll Free in US 800.237.9576 - FAX 218.828.1096 - [intercon@nortechsys.com](mailto:intercon@nortechsys.com)

## Mini Camera Link to Standard Camera Link – MCLCP-xx-P

### Product Outline

Mini Camera Link offers a smaller interface without sacrificing performance and quality.

Both standard and mini CL interface with the same pin configuration allowing cables to convert between both CL styles. This enables the use of a CL system that fits your specific needs.

Mini CL features an overmolded connector for the best strain relief. The high flex cable and locking thumbscrews add additional benefits when used in a motion application.

Durability is ensured with a unique jacket consisting of a blend of Teflon and Dacron creating a tough material that is both flexible and robust.



### Main Product Specifications

#### Features

- 1 million + flex life design
- Overmolded connectors
- Robust jacket capable of outdoor use
- 360 degree shielding
- RoHS Compliant



Cable Specifications	
Overall Diameter	.270 Inches
Max Temperature	80 Degrees C
Jacket Color	Black
UL/CSA Rated	Yes
Min. Bend Radius	2.70 Inches
Flame Rating	vw-1 / FT-1

Primary Components	
Cable	11 Individually Shielded Twisted Pairs
Connector A	26 Pos SDR (HDR)
Connector B	26 Pos MDR

### Ordering Information

Order Number	Length		Description
	Meters	Feet	
MCLCP-1.0-P	1.0	3.28	Mini CL to Standard CL High Flex
MCLCP-2.0-P	2.0	6.56	Mini CL to Standard CL High Flex
MCLCP-3.0-P	3.0	9.84	Mini CL to Standard CL High Flex
MCLCP-4.0-P	4.0	14.76	Mini CL to Standard CL High Flex
MCLCP-5.0-P	5.0	16.4	Mini CL to Standard CL High Flex

Custom variations are available. Please contact customer service for additional information.

[Return to Top](#)

**Custom variations available. Please contact customer service for additional information.**  
**Intercon 1** A Division of Nortech Systems, Inc. - 7746 Goedderz Road - Baxter, MN USA 56425  
 P 218.828.3157 - Toll Free in US 800.237.9576 - FAX 218.828.1096 - [intercon@nortechsys.com](mailto:intercon@nortechsys.com)

## MCLCP\*-xx-P & MCLCP\*-xx-MP

### Product Outline

Mini Camera Link offers a smaller interface without sacrificing the performance and quality that Intercon 1 brings to Camera Link products.

This assembly offers a unique right angle overmold that provides durable functionality in tight space constrictions. The overmold also features thumbscrew interlocking for dependable mating even through motion and vibration.

Because both standard and Mini Camera Link interface with the same pin configuration, cables are available that convert Mini to Standard. This enables the use of a Camera Link system that fits your specific needs. Both Mini and Standard Camera Link products are available with right angles

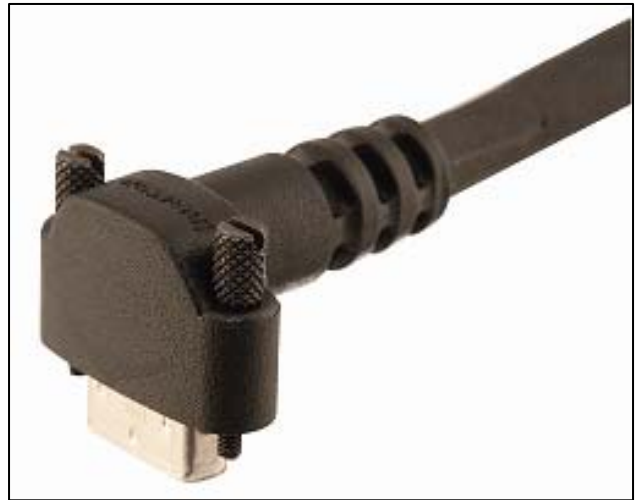

### Main Product Specifications

#### Features

- 1 million + flex life design
- Overmolded connectors
- Robust jacket capable of outdoor use
- Thumbscrew locking
- 360 degree shielding
- RoHS Compliant



#### Cable Specifications

Cable Specifications	
Overall Diameter	.270 Inches
Max Temperature	80 Degrees C
Jacket Color	Black
UL/CSA Rated	Yes
Min. Bend Radius	2.70 Inches
Flame Rating	vw-1 / FT-1

#### Primary Components

Primary Components	
Cable	11 Individually Shielded Twisted Pairs
Connector A	26 Pos SDR (HDR)
Connector B	26 Pos MDR or SDR (HDR)

### Ordering Information

Order Number	Description
MCLCP*-xx-P	Mini CL to Standard CL High Flex
MCLCP*-xx-MP	Mini CL to Standard CL High Flex

\* is replaced with either a "U" for Up or a "D" for Down  
 xx represents the cable length in meters (maximum 5 meters)

[Return to Top](#)

**Custom variations available. Please contact customer service for additional information.**  
**Intercon 1** A Division of Nortech Systems, Inc. - 7746 Goedderz Road - Baxter, MN USA 56425  
 P 218.828.3157 - Toll Free in US 800.237.9576 - FAX 218.828.1096 - [intercon@nortechsys.com](mailto:intercon@nortechsys.com)

## High Flex Power Over Camera Link – Standard – POCLP-xx-P

### Product Outline

This new Camera Link assembly is capable of transmitting power directly to the camera from a PC framegrabber while transmitting exceptional Camera Link signals, eliminating the need for a separate power supply at the camera.

The unique POCL marked overmold ensures that POCL will not be confused with a standard Camera Link assembly in the field.

The robust high flex cable along with overmolded interfaces, thumbscrew locking, and superior assembly techniques ensure that this cable will continue to perform in extreme industrial applications.



### Main Product Specifications

#### Features

- POCL marked Overmolding for easy identification
- Durable High Flex Cable
- Thumbscrew Locking
- Camera Link Certified
- 360 degree shielding
- RoHS Compliant



Cable Specifications	
Overall Diameter	.385 Inches
Max Temperature	80 Degrees C
Jacket Color	Black
UL/CSA Rated	20276 AWM I/II
Min. Bend Radius	3.85 Inches
Flame Rating	FT-1

Primary Components	
Cable	11 Individually Shielded Twisted Pairs
Connector A	26 Pos MDR
Connector B	26 Pos MDR

### Ordering Information

Order Number	Description
POCLP-xx-P	Industrial Power Over Camera Link

Replace xx with length in meters  
For cables longer than 10 meters contact customer service

[Return to Top](#)

**Custom variations available. Please contact customer service for additional information.**  
**Intercon 1** A Division of Nortech Systems, Inc. - 7746 Goedderz Road - Baxter, MN USA 56425  
 P 218.828.3157 - Toll Free in US 800.237.9576 - FAX 218.828.1096 - [intercon@nortechsys.com](mailto:intercon@nortechsys.com)

## High Flex Power Over Camera Link – Standard R/A – POCLP\*-xx-P

### Product Outline

This new Camera Link assembly is capable of transmitting power directly to the camera from a PC framegrabber while transmitting exceptional Camera Link signals, eliminating the need for a separate power supply at the camera.

The unique POCL marked overmold ensures that POCL will not be confused with a standard Camera Link assembly in the field.

Right angle Plug increases versatility in tight space applications by absorbing the strain of an immediate bend behind the camera interface.



### Main Product Specifications

#### Features

- POCL marked Overmolding for easy identification
- Durable High Flex Cable
- Right Angle Plug
- 360 degree shielding
- RoHS Compliant

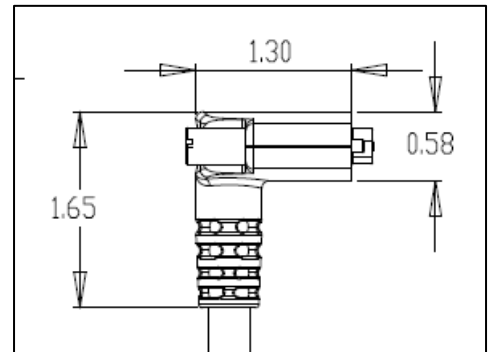

Cable Specifications	
Overall Diameter	.385 Inches
Max Temperature	80 Degrees C
Jacket Color	Black
UL/CSA Rated	20276 AWM I/II
Min. Bend Radius	3.85 Inches
Flame Rating	FT-1

Primary Components	
Cable	11 Individually Shielded Twisted Pairs
Connector A	26 Pos RA MDR
Connector B	26 Pos MDR

### Ordering Information

Order Number	Description
POCLP*-xx-P	Industrial Power Over Camera Link RA

Replace xx with length in meters  
 For cables longer than 10 meters contact customer service  
 Please replace the \* with a "U" for Up, a "D" for Down, an "R" for Right, or an "L" for Left.

[Return to Top](#)

**Custom variations available. Please contact customer service for additional information.**  
**Intercon 1** A Division of Nortech Systems, Inc. - 7746 Goedderz Road - Baxter, MN USA 56425  
 P 218.828.3157 - Toll Free in US 800.237.9576 - FAX 218.828.1096 - [intercon@nortechsys.com](mailto:intercon@nortechsys.com)

## High Flex Power Over Camera Link – Low Profile R/A – POCLP-xx-PL\*

### Product Outline

This new Camera Link assembly is capable of transmitting power directly to the camera from a PC framegrabber while transmitting exceptional Camera Link signals, eliminating the need for a separate power supply at the camera.

The POCL marked overmold ensures that POCL will not be confused with a standard Camera Link assembly in the field.

A low profile right angle plug increases versatility in tight space applications by absorbing the strain of an immediate bend behind the camera interface. The reduced height allows this cable to perform in even the tightest of applications.



### Main Product Specifications

#### Features

- POCL marked Overmolding for easy identification
- Durable High Flex Cable
- Low Profile Right Angle Plug
- 360 degree shielding
- RoHS Compliant

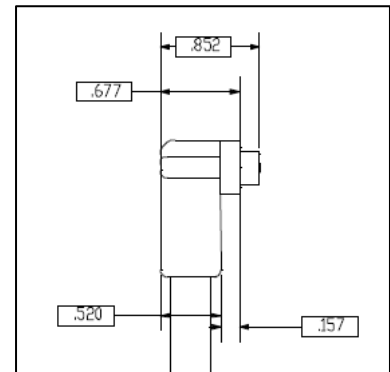

Cable Specifications	
Overall Diameter	.385 Inches
Max Temperature	80 Degrees C
Jacket Color	Black
UL/CSA Rated	20276 AWM I/II
Min. Bend Radius	3.85 Inches
Flame Rating	FT-1

Primary Components	
Cable	11 Individually Shielded Twisted Pairs
Connector A	26 Pos RA MDR
Connector B	26 Pos MDR

### Ordering Information

Order Number	Description
POCLP-xx-PL*	Industrial Power Over Camera Link LPRA

Replace xx with length in meters

For cables longer than 10 meters contact customer service

Please replace the \* with a "U" for Up, a "D" for Down.

[Return to Top](#)

**Custom variations available. Please contact customer service for additional information.**

**Intercon 1** A Division of Nortech Systems, Inc. - 7746 Goedderz Road - Baxter, MN USA 56425  
 P 218.828.3157 - Toll Free in US 800.237.9576 - FAX 218.828.1096 - [intercon@nortechsys.com](mailto:intercon@nortechsys.com)

## High Flex Power Over Mini Camera Link – POMCLP-xx-P

### Product Outline

This new Camera Link assembly is capable of transmitting power directly to the camera from a PC framegrabber while transmitting exceptional Camera Link signals, eliminating the need for a separate power supply at the camera.

The POCL marked overmold ensures that POCL will not be confused with a standard Camera Link assembly in the field.

The mini CL interface offers the same performance of standard CL in a compact size. This assembly allows for use between standard CL and Mini CL cameras and framegrabbers.

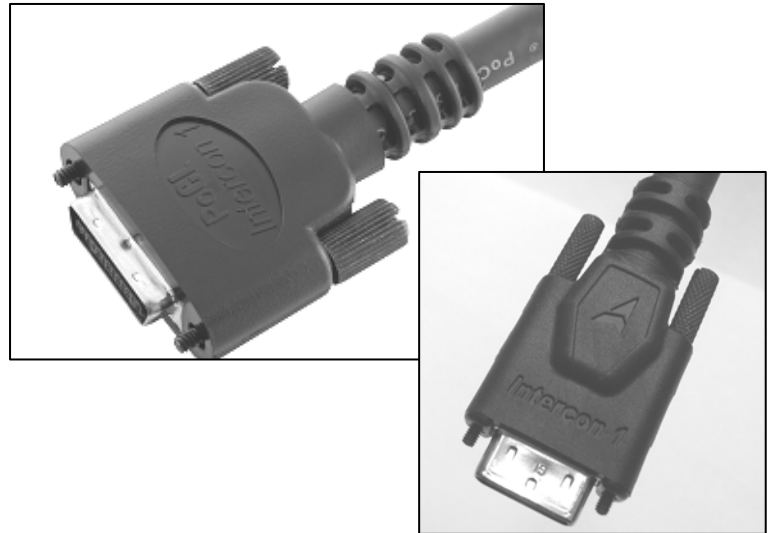

### Main Product Specifications

#### Features

- POCL marked Overmolding for easy identification
- Durable High Flex Cable
- Thumbscrew Locking
- 360 degree shielding
- RoHS Compliant

#### Cable Specifications

Cable Specifications	
Overall Diameter	.385 Inches
Max Temperature	80 Degrees C
Jacket Color	Black
UL/CSA Rated	20276 AWM I/II
Min. Bend Radius	3.85 Inches
Flame Rating	FT-1

#### Primary Components

Primary Components	
Cable	11 Individually Shielded Twisted Pairs
Connector A	26 Pos MDR
Connector B	26 Pos MDR

### Ordering Information

Order Number	Description
POMCLP-xx-P	Industrial Power Over Camera Link

Replace xx with length in meters  
For cables longer than 10 meters contact customer service

[Return to Top](#)

**Custom variations available. Please contact customer service for additional information.**  
**Intercon 1** A Division of Nortech Systems, Inc. - 7746 Goedderz Road - Baxter, MN USA 56425  
 P 218.828.3157 - Toll Free in US 800.237.9576 - FAX 218.828.1096 - [intercon@nortechsys.com](mailto:intercon@nortechsys.com)

## High Flex Power Over Mini Camera Link – POMCLP-xx-MP

### Product Outline

This new Camera Link assembly is capable of transmitting power directly to the camera from a PC framegrabber while transmitting exceptional Camera Link signals, eliminating the need for a separate power supply at the camera.

The POCL marked overmold ensures that POCL will not be confused with a standard Camera Link assembly in the field.

The mini CL interface offers the same performance of standard CL in a compact size. Combined with a high flex cable and durable overmolding, this offers the most versatile and robust Camera Link assembly.



### Main Product Specifications

#### Features

- POCL marked Overmolding for easy identification
- Durable High Flex Cable
- Thumbscrew Locking
- 360 degree shielding
- RoHS Compliant

#### Cable Specifications

Overall Diameter	.385 Inches
Max Temperature	80 Degrees C
Jacket Color	Black
UL/CSA Rated	20276 AWM I/II
Min. Bend Radius	3.85 Inches
Flame Rating	FT-1

#### Primary Components

Cable	11 Individually Shielded Twisted Pairs
Connector A	26 Pos MDR
Connector B	26 Pos MDR

### Ordering Information

Order Number	Description
POMCLP-xx-MP	Industrial Power Over Mini CL

Replace xx with length in meters  
For cables longer than 10 meters contact customer service

[Return to Top](#)

**Custom variations available. Please contact customer service for additional information.**  
**Intercon 1** A Division of Nortech Systems, Inc. - 7746 Goedderz Road - Baxter, MN USA 56425  
 P 218.828.3157 - Toll Free in US 800.237.9576 - FAX 218.828.1096 - [intercon@nortechsys.com](mailto:intercon@nortechsys.com)



## Industrial High Flex Gig E Assemblies Horizontal – F-GEVPT-xx-P

### Product Outline

Industrial High Flex Gig E cables are designed to interface Gig E and Gig E Vision cameras directly to a computer, eliminating the need for frame grabbers.

F-GEVPT is the solution for brutal applications that require more than the traditional CAT 5 cable can offer. Our unique overmold design provides increased strain relief. The thumbscrew locking feature ensures that the interface will remain secure despite motion and vibration. The double shielded design offers superior protection and performance.

The high flex cable is designed to withstand 12 million + flex cycles. The durable TPE jacket provides additional protection from elements such as water, oil, and abrasion.

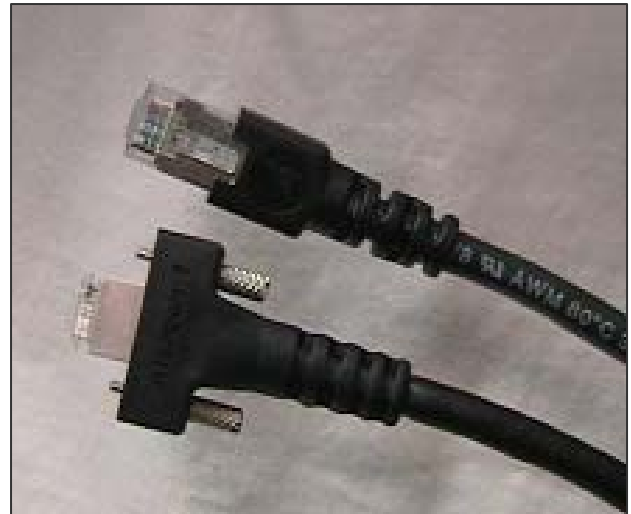

### Main Product Specifications

#### Features

- Low profile overmolded strain relief
- Thumbscrew locking
- High flex cable
- Robust TPE jacket
- RoHS Compliant
- Short strain relief available for thumbscrew end

#### Cable Specifications

Overall Diameter	.245 Inches
Max Temperature	80 Degrees C
Jacket Color	Black
UL/CSA Rated	Yes
Min. Bend Radius	2.45 Inches
Flame Rating	FT-1

#### Primary Components

Cable	4 Twisted Pairs
Connector A	Honda RJ45
Connector B	Standard RJ45

### Ordering Information

Order Number	Description
F-GEVPT-xx-P	High Flex Gig E Horizontal Overmold

Replace xx with length in meters

[Return to Top](#)

**Custom variations available. Please contact customer service for additional information.**  
**Intercon 1** A Division of Nortech Systems, Inc. - 7746 Goedderz Road - Baxter, MN USA 56425  
 P 218.828.3157 - Toll Free in US 800.237.9576 - FAX 218.828.1096 - [intercon@nortechsys.com](mailto:intercon@nortechsys.com)

# Gig E Vision

## Industrial High Flex Gig E Assemblies – Vertical - F-GEVVPT-xx-P

### Product Outline

Industrial High Flex Gig E cables are designed to interface Gig E and Gig E Vision cameras directly to a computer, eliminating the need for frame grabbers.

F-GEVVPT is the solution for brutal applications that require more than the traditional CAT 5 cable can offer. Our unique overmold design provides increased strain relief. The thumbscrew locking feature ensures that the interface will remain secure despite motion and vibration. The double shielded design offers superior protection and performance.

The high flex cable is designed to withstand 12 million + flex cycles. The durable TPE jacket provides additional protection from elements such as water, oil, and abrasion.



### Main Product Specifications

#### Features

- Overmolded strain relief
- Thumbscrew locking
- High flex cable
- Robust TPE jacket
- Double shielded
- RoHS compliant

#### Cable Specifications

Overall Diameter	.245 Inches
Max Temperature	80 Degrees C
Jacket Color	Black
UL/CSA Rated	Yes
Min. Bend Radius	2.45 Inches
Flame Rating	FT-1

#### Primary Components

Cable	4 Twisted Pairs
Connector A	Standard RJ45
Connector B	Standard RJ45

### Ordering Information

Order Number	Description
F-GEVVPT-xx-P	High Flex Gig E Horizontal Overmold

Replace xx with length in meters

[Return to Top](#)

**Custom variations available. Please contact customer service for additional information.**  
**Intercon 1** A Division of Nortech Systems, Inc. - 7746 Goedderz Road - Baxter, MN USA 56425  
P 218.828.3157 - Toll Free in US 800.237.9576 - FAX 218.828.1096 - [intercon@nortechsys.com](mailto:intercon@nortechsys.com)

# Gig E Vision

## Industrial High Flex Gig E Assemblies – F-GEVP-xx-P

### Product Outline

Industrial High Flex Gig E cables are designed to interface Gig E and Gig E Vision cameras directly to a computer, eliminating the need for frame grabbers.

F-GEVP is the solution for brutal applications that require more than the traditional CAT 5 cable can offer. Double shielded cable ensures the best electrical performance. Our unique overmold design provides increased strain relief.

The high flex cable is designed to withstand 12 million + flex cycles. The durable TPE jacket provides additional protection from elements such as water, oil, and abrasion.



### Main Product Specifications

#### Features

- Overmolded strain relief
- High flex cable
- Robust TPE jacket
- Double shielded
- RoHS Compliant

#### Cable Specifications

Cable Specifications	
Overall Diameter	.245 Inches
Max Temperature	80 Degrees C
Jacket Color	Black
UL/CSA Rated	Yes
Min. Bend Radius	2.45 Inches
Flame Rating	FT-1

#### Primary Components

Primary Components	
Cable	4 Twisted Pairs
Connector A	Standard RJ45
Connector B	Standard RJ45

### Ordering Information

Order Number	Description
F-GEVP-xx-P	High Flex Gig E

Replace xx with length in meters

[Return to Top](#)

**Custom variations available. Please contact customer service for additional information.**  
**Intercon 1** A Division of Nortech Systems, Inc. - 7746 Goedderz Road - Baxter, MN USA 56425  
P 218.828.3157 - Toll Free in US 800.237.9576 - FAX 218.828.1096 - [intercon@nortechsys.com](mailto:intercon@nortechsys.com)

# IEEE 1394a

## IEEE 1394a Type A to Type A – MIDAP-xx-PA

### Product Outline

These standard IEEE 1394 interface assemblies, also referred to as FireWire or i.Link, use precision computer quality cable and rugged molded connector hoods to ensure durability and high quality video image transmission. Precision assembly and resilient industrial-grade PVC compounds in the overmolding material provide dependable operation.

This compact and inexpensive cable provides a high speed industry standard serial bus with data transfer rates of 100, 200, or 400 Mbps.



### Main Product Specifications

#### Features

- Low cost IEEE 1394a
- Industrial design
- Supports Plug and Play
- High data transfer rates
- Supports multiple devices

#### Cable Specifications

Cable Specifications	
Overall Diameter	.22 Inches
Max Temperature	60 Degrees C
Jacket Color	Black
UL/CSA Rated	Yes
Data Transfer Rate	100 / 200 / 400 Mps
Min. Bend Radius	3.30 Inches

#### Primary Components

Primary Components	
Cable	IEEE 1394a Cable
Connector A	6 Pos Type A
Connector B	6 Pos Type A

### Ordering Information

Order Number	Length		Description
	Meters	Feet	
MIDAP-1.9-PA	1.9	6.0	Type A to Type A
MIDAP-3.05-PA	3.05	10.0	Type A to Type A
MIDAP-4.6-PA	4.6	15.0	Type A to Type A

[Return to Top](#)

**Custom variations available. Please contact customer service for additional information.**  
**Intercon 1** A Division of Nortech Systems, Inc. - 7746 Goedderz Road - Baxter, MN USA 56425  
P 218.828.3157 - Toll Free in US 800.237.9576 - FAX 218.828.1096 - [intercon@nortechsys.com](mailto:intercon@nortechsys.com)

# IEEE 1394a

## IEEE 1394a Type A to Type B – MIDAP-xx-PB

### Product Outline

These standard IEEE 1394 interface assemblies, also referred to as FireWire or i.Link, use precision computer quality cable and rugged molded connector hoods to ensure durability and high quality video image transmission. Precision assembly and resilient industrial-grade PVC compounds in the overmolding material provide dependable operation.

This compact and inexpensive cable provides a high speed industry standard serial bus with data transfer rates of 100, 200, or 400 Mbps.



### Main Product Specifications

#### Features

- Low cost IEEE 1394a
- Industrial design
- Supports Plug and Play
- High data transfer rates
- Supports multiple devices

#### Cable Specifications

Cable Specifications	
Overall Diameter	.22 Inches
Max Temperature	60 Degrees C
Jacket Color	Black
UL/CSA Rated	Yes
Data Transfer Rate	100 / 200 / 400 Mps
Min. Bend Radius	3.30 Inches

#### Primary Components

Primary Components	
Cable	IEEE 1394a Cable
Connector A	6 Pos Type A
Connector B	6 Pos Type B

### Ordering Information

Order Number	Length		Description
	Meters	Feet	
MIDAP-1.9-PB	1.9	6.0	Type A to Type B
MIDAP-3.05-PB	3.05	10.0	Type A to Type B
MIDAP-4.6-PB	4.6	15.0	Type A to Type B

[Return to Top](#)

**Custom variations available. Please contact customer service for additional information.**  
**Intercon 1** A Division of Nortech Systems, Inc. - 7746 Goedderz Road - Baxter, MN USA 56425  
P 218.828.3157 - Toll Free in US 800.237.9576 - FAX 218.828.1096 - [intercon@nortechsys.com](mailto:intercon@nortechsys.com)

# IEEE 1394a

## IEEE 1394a Type B to Type B – MIDBP-xx-PB

### Product Outline

These standard IEEE 1394 interface assemblies, also referred to as FireWire or i.Link, use precision computer quality cable and rugged molded connector hoods to ensure durability and high quality video image transmission. Precision assembly and resilient industrial-grade PVC compounds in the overmolding material provide dependable operation.

This compact and inexpensive cable provides a high speed industry standard serial bus with data transfer rates of 100, 200, or 400 Mbps.



### Main Product Specifications

#### Features

- Low cost IEEE 1394a
- Industrial design
- Supports Plug and Play
- High data transfer rates
- Supports multiple devices

#### Cable Specifications

Cable Specifications	
Overall Diameter	.22 Inches
Max Temperature	60 Degrees C
Jacket Color	Black
UL/CSA Rated	Yes
Data Transfer Rate	100 / 200 / 400 Mps
Min. Bend Radius	3.30 Inches

#### Primary Components

Primary Components	
Cable	IEEE 1394a Cable
Connector A	6 Pos Type B
Connector B	6 Pos Type B

### Ordering Information

#### Length

Order Number	Length		Description
	Meters	Feet	
MIDBP-1.9-PB	1.9	6.0	Type B to Type B
MIDBP-3.05-PB	3.05	10.0	Type B to Type B
MIDBP-4.6-PB	4.6	15.0	Type B to Type B

[Return to Top](#)

**Custom variations available. Please contact customer service for additional information.**  
**Intercon 1** A Division of Nortech Systems, Inc. - 7746 Goedderz Road - Baxter, MN USA 56425  
P 218.828.3157 - Toll Free in US 800.237.9576 - FAX 218.828.1096 - [intercon@nortechsys.com](mailto:intercon@nortechsys.com)

# IEEE 1394a



<http://www.intercon-1.com>

## InfiniFlex IEEE 1394a Type A – A w/ Latches – IF-MIDAPC-xx-PAC

### Product Outline

These high flex IEEE 1394a type interface assemblies use a proprietary industrial grade Intercon 1 InfiniFlex cable integrated with squeeze latch connector hoods to ensure secure, easy locking through motion and vibration. InfiniFlex products are designed to surpass 10 million flex cycles in demanding industrial applications, ensuring years of uninterrupted performance.

The exceptional cable design transmits data at rates up to 400 Mbps. This high performance FireWire cable has performed at lengths exceeding the IEEE 1394 standards in a variety of applications.



### Main Product Specifications

#### Features

- InfiniFlex – 10 million + flex cable
- Quick latch locking
- Superior Performance at long lengths
- Supports Plug and Play
- Compatible with IEEE 1394a

#### Cable Specifications

Overall Diameter	.320 Inches
Max Temperature	80 Degrees C
Jacket Color	Violet
UL/CSA Rated	Yes
Min. Bend Radius	3.20 Inches
Flame Rating	VW-1 / FT-1

#### Primary Components

Cable	IEEE 1394a type
Connector A	6 Pos IEEE 1394 Plug
Connector B	6 Pos IEEE 1394 Plug

### Ordering Information

Order Number	Length		Description
	Meters	Feet	
IF-MIDAPC-1.0-PAC	1.0	3.28	InfiniFlex Firewire Type A-A w/ Latches
IF-MIDAPC-2.0-PAC	2.0	6.56	InfiniFlex Firewire Type A-A w/ Latches
IF-MIDAPC-3.0-PAC	3.0	9.84	InfiniFlex Firewire Type A-A w/ Latches
IF-MIDAPC-4.0-PAC	4.0	13.12	InfiniFlex Firewire Type A-A w/ Latches
IF-MIDAPC-5.0-PAC	5.0	16.40	InfiniFlex Firewire Type A-A w/ Latches

Custom variations are available. Please contact customer service for additional information.

[Return to Top](#)

**Custom variations available. Please contact customer service for additional information.**

**Intercon 1** A Division of Nortech Systems, Inc. - 7746 Goedderz Road - Baxter, MN USA 56425  
P 218.828.3157 - Toll Free in US 800.237.9576 - FAX 218.828.1096 - [intercon@nortechsys.com](mailto:intercon@nortechsys.com)

# IEEE 1394a

## InfiniFlex IEEE 1394a Type A – A w/ Thumbscrews – IF-MIDAPT-xx-PAT

### Product Outline

These high flex IEEE 1394a type interface assemblies use a proprietary industrial grade Intercon 1 InfiniFlex cable integrated with overmolded thumbscrew locking to ensure a constant secure connection through motion and vibration. InfiniFlex products are designed to surpass 10 million flex cycles in demanding industrial applications, ensuring years of uninterrupted performance.

The exceptional cable design transmits data at rates up to 400 Mbps. This high performance FireWire cable has performed at lengths exceeding the IEEE 1394 standards in a variety of applications.



### Main Product Specifications

#### Features

- InfiniFlex – 10 million + flex cable
- Thumbscrew locking
- Superior Performance at long lengths
- Supports Plug and Play
- Compatible with IEEE 1394a

#### Cable Specifications

Cable Specifications	
Overall Diameter	.320 Inches
Max Temperature	80 Degrees C
Jacket Color	Violet
UL/CSA Rated	Yes
Min. Bend Radius	3.20 Inches
Flame Rating	VW-1 / FT-1

#### Primary Components

Primary Components	
Cable	IEEE 1394a type
Connector A	6 Pos IEEE 1394 Plug
Connector B	6 Pos IEEE 1394 Plug

### Ordering Information

Order Number	Length		Description
	Meters	Feet	
IF-MIDAPT-1.0-PAT	1.0	3.28	InfiniFlex Firewire Type A-A w/ Thumbscrews
IF-MIDAPT-2.0-PAT	2.0	6.56	InfiniFlex Firewire Type A-A w/ Thumbscrews
IF-MIDAPT-3.0-PAT	3.0	9.84	InfiniFlex Firewire Type A-A w/ Thumbscrews
IF-MIDAPT-4.0-PAT	4.0	13.12	InfiniFlex Firewire Type A-A w/ Thumbscrews
IF-MIDAPT-5.0-PAT	5.0	16.40	InfiniFlex Firewire Type A-A w/ Thumbscrews

Custom variations are available. Please contact customer service for additional information.

[Return to Top](#)

**Custom variations available. Please contact customer service for additional information.**

**Intercon 1** A Division of Nortech Systems, Inc. - 7746 Goedderz Road - Baxter, MN USA 56425  
P 218.828.3157 - Toll Free in US 800.237.9576 - FAX 218.828.1096 - [intercon@nortechsys.com](mailto:intercon@nortechsys.com)



# IEEE 1394a

## InfiniFlex IEEE 1394a Type A – Type A – IF-MIDAP-xx-PA

### Product Outline

These high flex IEEE 1394a type interface assemblies use a proprietary industrial grade Intercon 1 InfiniFlex cable integrated with overmolded thumbscrew locking to ensure a constant secure connection through motion and vibration. InfiniFlex products are designed to surpass 10 million flex cycles in demanding industrial applications, ensuring years of uninterrupted performance.

The exceptional cable design transmits data at rates up to 400 Mbps. This high performance FireWire cable has performed at lengths exceeding the IEEE 1394 standards in a variety of applications.



### Main Product Specifications

#### Features

- InfiniFlex – 10 million + flex cable
- Robust overmolded interfaces
- Superior Performance at long lengths
- Supports Plug and Play
- Compatible with IEEE 1394a

#### Cable Specifications

Cable Specifications	
Overall Diameter	.320 Inches
Max Temperature	80 Degrees C
Jacket Color	Violet
UL/CSA Rated	Yes
Min. Bend Radius	3.20 Inches
Flame Rating	VW-1 / FT-1

#### Primary Components

Primary Components	
Cable	IEEE 1394a type
Connector A	6 Pos IEEE 1394 Plug
Connector B	6 Pos IEEE 1394 Plug

### Ordering Information

Order Number	Length		Description
	Meters	Feet	
IF-MIDAP-1.0-PA	1.0	3.28	InfiniFlex Firewire Type A-A
IF-MIDAP-2.0-PA	2.0	6.56	InfiniFlex Firewire Type A-A
IF-MIDAP-3.0-PA	3.0	9.84	InfiniFlex Firewire Type A-A
IF-MIDAP-4.0-PA	4.0	13.12	InfiniFlex Firewire Type A-A
IF-MIDAP-5.0-PA	5.0	16.40	InfiniFlex Firewire Type A-A

Custom variations are available. Please contact customer service for additional information.

[Return to Top](#)

**Custom variations available. Please contact customer service for additional information.**

**Intercon 1** A Division of Nortech Systems, Inc. - 7746 Goedderz Road - Baxter, MN USA 56425  
P 218.828.3157 - Toll Free in US 800.237.9576 - FAX 218.828.1096 - [intercon@nortechsys.com](mailto:intercon@nortechsys.com)

# IEEE 1394b

## High Flex IEEE 1394b - Bilingual – F-FWBPT-xx-PA6

### Product Outline

IEEE 1394b allows for data transfer rates up to 800 Mbps while maintaining signal integrity.

The combination of a high flex cable, durable overmolded strain reliefs, and thumbscrew locking delivers reliable performance in the most demanding applications.

These bilingual cables are designed to interface between 1394a and 1394b equipment.



### Main Product Specifications

#### Features

- High flex cable designed to surpass 11 million cycles
- Thumbscrew locking to ensure secure connection
- Overmolded interfaces for superior strain relief
- RoHS Compliant
- Double shielded to maximize performance

#### Cable Specifications

Overall Diameter	.230 Inches
Max Temperature	80 Degrees C
Jacket Color	Green
UL/CSA Rated	Yes
Min. Bend Radius	2.30 Inches
Flame Rating	FT-1

#### Primary Components

Cable	2 Shielded Twisted Pairs - 2 Discrete Wires
Connector A	9 position 1394b bilingual plug
Connector B	6 Position 1394a plug (also available with thumbscrews)

### Ordering Information

#### Length

Order Number	Length		Description
	Meters	Feet	
F-FWBPT-1.0-PA6	1.0	3.28	IEEE 1394 Bilingual Cable
F-FWBPT-2.0-PA6	2.0	6.56	IEEE 1394 Bilingual Cable
F-FWBPT-3.0-PA6	3.0	9.84	IEEE 1394 Bilingual Cable
F-FWBPT-4.0-PA6	4.0	13.12	IEEE 1394 Bilingual Cable
F-FWBPT-5.0-PA6	5.0	16.40	IEEE 1394 Bilingual Cable

Custom variations are available. Please contact customer service for additional information.

[Return to Top](#)

**Custom variations available. Please contact customer service for additional information.**

**Intercon 1** A Division of Nortech Systems, Inc. - 7746 Goedderz Road - Baxter, MN USA 56425  
 P 218.828.3157 - Toll Free in US 800.237.9576 - FAX 218.828.1096 - [intercon@nortechsys.com](mailto:intercon@nortechsys.com)

# IEEE 1394b

## High Flex IEEE 1394b - Beta – F-FWBPT-xx-PB

### Product Outline

IEEE 1394b allows for data transfer rates up to 800 Mbps while maintaining signal integrity.

The combination of a high flex cable, durable overmolded strain reliefs, and thumbscrew locking delivers reliable performance in the most demanding applications.

Beta cables interface between 1394b equipment while bilingual cables interface 1394b to 1394a. Both versions are available.

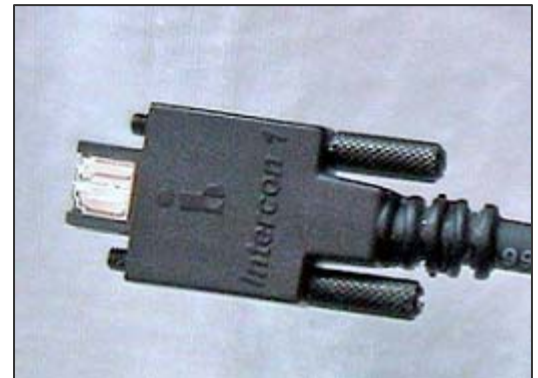

### Main Product Specifications

#### Features

- High flex cable designed to surpass 11 million cycles
- Thumbscrew locking to ensure secure connection in one end
- Overmolded interfaces for superior strain relief
- Supports Plug and Play
- RoHS Compliant
- Double shielded to maximize performance

#### Cable Specifications

Cable Specifications	
Overall Diameter	.230 Inches
Max Temperature	80 Degrees C
Jacket Color	Green
UL/CSA Rated	Yes
Min. Bend Radius	2.30 Inches
Flame Rating	FT-1

#### Primary Components

Primary Components	
Cable	2 Shielded Twisted Pairs - 2 Discrete Wires
Connector A	9 position 1394b beta plug
Connector B	9 position 1394b beta plug

### Ordering Information

#### Length

Order Number	Length		Description
	Meters	Feet	
F-FWBPT-1.0-PB	1.0	3.28	IEEE 1394 Beta Cable
F-FWBPT-2.0-PB	2.0	6.56	IEEE 1394 Beta Cable
F-FWBPT-3.0-PB	3.0	9.84	IEEE 1394 Beta Cable
F-FWBPT-4.0-PB	4.0	13.12	IEEE 1394 Beta Cable
F-FWBPT-5.0-PB	5.0	16.40	IEEE 1394 Beta Cable

Custom variations are available. Please contact customer service for additional information.

[Return to Top](#)

**Custom variations available. Please contact customer service for additional information.**

**Intercon 1** A Division of Nortech Systems, Inc. - 7746 Goedderz Road - Baxter, MN USA 56425  
P 218.828.3157 - Toll Free in US 800.237.9576 - FAX 218.828.1096 - [intercon@nortechsys.com](mailto:intercon@nortechsys.com)

# IEEE 1394b

## High Flex IEEE 1394b - Beta – F-FWBPT-xx-PBT

### Product Outline

IEEE 1394b allows for data transfer rates up to 800 Mbps while maintaining signal integrity.

The combination of a high flex cable, durable overmolded strain reliefs, and thumbscrew locking delivers reliable performance in the most demanding applications.

Beta cables interface between 1394b equipment while bilingual cables interface 1394b to 1394a. Both versions are available.

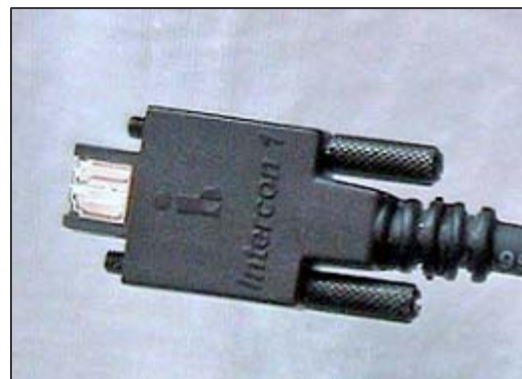

### Main Product Specifications

#### Features

- High flex cable designed to surpass 11 million cycles
- Thumbscrew locking to ensure secure connection on both ends
- Overmolded interfaces for superior strain relief
- Supports Plug and Play
- RoHS Compliant
- Double shielded to maximize performance

#### Cable Specifications

Overall Diameter	.230 Inches
Max Temperature	80 Degrees C
Jacket Color	Green
UL/CSA Rated	Yes
Min. Bend Radius	2.30 Inches
Flame Rating	FT-1

#### Primary Components

Cable	2 Shielded Twisted Pairs - 2 Discrete Wires
Connector A	9 position 1394b beta plug
Connector B	9 position 1394b beta plug

### Ordering Information

Order Number	Length		Description
	Meters	Feet	
F-FWBPT-1.0-PBT	1.0	3.28	IEEE 1394 Beta Cable
F-FWBPT-2.0-PBT	2.0	6.56	IEEE 1394 Beta Cable
F-FWBPT-3.0-PBT	3.0	9.84	IEEE 1394 Beta Cable
F-FWBPT-4.0-PBT	4.0	13.12	IEEE 1394 Beta Cable
F-FWBPT-5.0-PBT	5.0	16.40	IEEE 1394 Beta Cable

Custom variations are available. Please contact customer service for additional information.

[Return to Top](#)

**Custom variations available. Please contact customer service for additional information.**

**Intercon 1** A Division of Nortech Systems, Inc. - 7746 Goedderz Road - Baxter, MN USA 56425  
P 218.828.3157 - Toll Free in US 800.237.9576 - FAX 218.828.1096 - [intercon@nortechsys.com](mailto:intercon@nortechsys.com)

## InfiniFlex USB 2.0 – IF-B2PA-xx-PA

### Product Outline

Designed to surpass 10 million flex cycles in the most extreme conditions, this unique cable continues to transmit high quality USB 2.0 signals through bending, torsion, and pulling, creating the perfect solution for industrial USB applications.

The rugged overmold offers additional strain relief and increases the assembly's ability to perform with dependability.

The small cable OD allows continued performance and reliability at a tight bend radius.



### Main Product Specifications

#### Features

- 10 million + flex design
- Overmolded interfaces
- Small bend radius
- Dual shielding
- Double shielded to maximize performance

#### Cable Specifications

Cable Specifications	
Overall Diameter	.117 Inches
Max Temperature	80 Degrees C
Jacket Color	Violet
UL/CSA Rated	Yes
Min. Bend Radius	1.77 Inches
Flame Rating	VW-1

#### Primary Components

Primary Components	
Cable	1 Twisted Pair - 2 Discrete Wires
Connector A	USB 2.0 Type A Plug
Connector B	USB 2.0 Type A Plug

### Ordering Information

Order Number	Length		Description
	Meters	Feet	
IF-B2PA-1.0-PA	1.0	3.28	Infiniflex USB 2.0 Type A to Type A
IF-B2PA-2.0-PA	2.0	6.56	Infiniflex USB 2.0 Type A to Type A
IF-B2PA-3.0-PA	3.0	9.84	Infiniflex USB 2.0 Type A to Type A
IF-B2PA-4.0-PA	4.0	13.12	Infiniflex USB 2.0 Type A to Type A
IF-B2PA-5.0-PA	5.0	16.40	Infiniflex USB 2.0 Type A to Type A

Custom variations are available. Please contact customer service for additional information.

[Return to Top](#)

**Custom variations available. Please contact customer service for additional information.**

**Intercon 1** A Division of Nortech Systems, Inc. - 7746 Goedderz Road - Baxter, MN USA 56425  
P 218.828.3157 - Toll Free in US 800.237.9576 - FAX 218.828.1096 - [intercon@nortechsys.com](mailto:intercon@nortechsys.com)

# GPIO

## GPIO Control Cables – GPIO-xx-PS

### Product Outline

Designed for use with GeviCam Gig E cameras, this General Purpose Input/ Output cable provides a variety of functions including external trigger, strobe, RS-485, Audio I/O, and temperature sensing.

This industrial assembly features an overmolded strain relief for maximum stress dispersion. The overmold allows for the use of thumbscrews to secure the interface.

A high flex cable ensures that this robust assembly will continue to perform even in rigorous motion applications.



### Main Product Specifications

#### Features

- High flex cable
- Overmolded strain relief
- Thumbscrew locking

Pin Configuration

1	12VDC Gnd	8	12 VDC+
2	Gnd	9	Trigger In
3	Strobe Out	10	RS-485
4	RS 485 +	11	Opto D1 in -
5	Opto D1 in +	12	Opto D2 out -
6	Opto D2 out +	13	Audio out
7	Gnd	14	Audio in

#### Cable Specifications

Overall Diameter	.250 Inches
Max Temperature	80 Degrees C
Jacket Color	Black
Min. Bend Radius	1.77 Inches

#### Primary Components

Cable	4TW PR, 2 Discrete, 4 Coaxes
Connector A	14 Pos MDR Plug
Connector B	14 Pos MDR Plug

### Ordering Information

#### Length

Order Number	Length		Description
	Meters	Feet	
GPIO-2.0-PS	1.0	3.28	Infiniflex USB 2.0 Type A to Type A
IF-B2PA-2.0-PA	2.0	6.56	Infiniflex USB 2.0 Type A to Type A
IF-B2PA-3.0-PA	3.0	9.84	Infiniflex USB 2.0 Type A to Type A
IF-B2PA-4.0-PA	4.0	13.12	Infiniflex USB 2.0 Type A to Type A
IF-B2PA-5.0-PA	5.0	16.40	Infiniflex USB 2.0 Type A to Type A

Custom variations are available. Please contact customer service for additional information.

[Return to Top](#)

**Custom variations available. Please contact customer service for additional information.**

**Intercon 1** A Division of Nortech Systems, Inc. - 7746 Goedderz Road - Baxter, MN USA 56425  
P 218.828.3157 - Toll Free in US 800.237.9576 - FAX 218.828.1096 - [intercon@nortechsys.com](mailto:intercon@nortechsys.com)

# Remote Head Cross List

## Camera Head to Control Unit Assemblies

### Product Outline

Intercon 1 offers a variety of Remote Head cables to interface between camera heads and control units.

Most configurations are available in high flex, Teflon, and right angle versions.

In addition, we offer custom lengths as well as extension cables and couplers.



### Cross List to Camera Model

Intercon 1 Part Number	Camera Model	Cable Number
RHC1P-8.0-SJ	GP-CD-1	CP-CA31
RHC2P-**-SJ	GP-MF200	WV-CS**
RHC3S-**-P	IK-C40, IK-M40, IK-M41	EXC-4**M
RHC3S-**-P	CN-401E, MP-481PAL, ME-411E, ME-421	EMC-**-A
RHC4P-**-P	IK-M30, IK-C30, EC-202, EM102	EXC-3**M
RHC5P-**-P	IK-M30, IK-C30, EC-202II, EM102II	EXC-3**M Screw lock
RHC6S-**-P	GP-KS102	GP-CA44, GP-CA45, GP-CA46, GP-CA48, GP-CA49
RHC7P-**-DS	4980	8358-**-
RHC8S-**-P	GP-KS162	GPCA-162/*
RHC9P-**-P	IK-TU40A	EXC-T4**
RHC10S-**-P	M10000K	CV-M1200K, CV-M1250K
RHC11S-**-P	IK-M43, IK-CU34A, MN-42H, CN-42H	EXC-43**
RHC12S-**-P	KP-C230	EMC-**H
RHC13S-**-P	IK-UM42A, UN411E	C**2KAC
RHC14S-**-P	GP-KS1000	GP-CAK/*
RHC15S-**-P	HV-D27, HV-D37	C**KAJ/T
RHC17S-**-P	XC-55BB, XC-333	CCXC-T20P02, CCXC-T20P05, CCXC-T20P10
RHC18S-**-P	CS5131-01	CPC5131M-**J
RHC19S-**-P	GPKS-532	GP-CA522/4
RHC20XSJ-**-P	IK-7XD	Extension
RHC22S-**-P	GP-US502	GP-CA63
RHC23P-**-P	IK-TU51	T503, T506, T510
RHC24S-**-P	DXC-C33, DXC-C33P	CCMC-

Custom variations are available. Please contact customer service for additional information.

[Return to Top](#)

# Power Supplies

## North American Wall Mount Transformer – WIPS

### Product Outline

These low cost Intercon 1 AC adapters have proven reliability over years of continued performance.

The lightweight design increases usability on the line and in the field.

The 22AWG cord features a flat Siamese design that separates easily with minimal residue for clean power lead applications



### Main Product Specifications

#### Features

- 22AWG output chord
- Low cost
- RoHS Compliant versions available
- 15ft output cord for longer length assemblies without splicing

#### Power Supply Specifications

Watts	15.5 W
Voltage In	120 VAC
Voltage Out	12 VDC
Amperage Out	800 mA
Regulated	No
Ratings	Class II

### Ordering Information

WIPS  
(Transformer Unit)           Series\*    ----           Length in feet\*\*

\* See Page 52

\*\* 6ft, 10ft, 15ft standard

Custom variations are available. Please contact customer service for additional information.

[Return to Top](#)



# Power Supplies

## International Wall Mount Transformer – PSI

### Product Outline

The PSI transformer is designed for North American and international use. The unique switchable blades allow this power transformer to perform globally without the need for additional cord sets.

This regulated light weight, compact model offers additional benefits for ease of use and space restricted applications.

Overload and short circuit protection provide excellent safeguards for your equipment.



### Main Product Specifications

#### Features

- Convenient switchable blade unit
- Switching input
- Regulated
- 20 AWG output cord
- RoHS Compliant

#### Power Supply Specifications

Power Supply Specifications	
Watts	15 W
Voltage In	100-240 VAC
Voltage Out	12 VDC
Amperage Out	1.25 A
Regulated	Yes
Ratings	CE Class II

### Ordering Information

PSI \_\_\_\_\_ ---- \_\_\_\_\_ Length in feet\*\*  
(Transformer Unit) Series\*

\* See Page 52

\*\* 6ft, 10ft, 15ft standard

Custom variations are available. Please contact customer service for additional information.

[Return to Top](#)

# Power Supplies

## Desktop Style for North American Use - DPS

### Product Outline

This light weight desktop offers high performance in a compact size.

The large output capabilities enable this unit to be used in a variety of applications including powering multiple cameras.

The LED indicator offers a quick reference for ease of use.

IEC 320 cordsets are included.



### Main Product Specifications

#### Features

- Small compact enclosure
- Regulated
- Short Circuit/ Overload Protection
- Switching input
- RoHS Compliant

#### Power Supply Specifications

Watts	30 W
Voltage In	100-240 VAC
Voltage Out	9-12 VDC
Amperage Out	3 A
Regulated	Yes
Ratings	UL, CUL, TUV, CE, BSMI

### Ordering Information

DPS  
(Transformer Unit)      Series\*      Length in feet\*\*

\* See Page 52

\*\* 6ft, 10ft, 15ft standard

Custom variations are available. Please contact customer service for additional information.

[Return to Top](#)

# Power Supplies

## Desktop Style for International Use – IPS

### Product Outline

This light weight desktop offers high performance in a compact size.

The large output capabilities enable this unit to be used in a variety of applications including powering multiple cameras.

The LED indicator offers a quick reference for ease of use.

This unit ships with the international cordset or your choice.



### Main Product Specifications

#### Features

- Small compact enclosure
- Regulated
- Short Circuit/ Overload Protection
- Switching input
- RoHS Compliant

#### Power Supply Specifications

Watts	30 W
Voltage In	100-240 VAC
Voltage Out	9-12 VDC
Amperage Out	3 A
Regulated	Yes
Ratings	UL, CUL, TUV, CE, BSMI

### Ordering Information

IPS  
(Transformer Unit)      Series\*      Length in feet\*\*

\* See Page 52

\*\* 6ft, 10ft, 15ft standard

Custom variations are available. Please contact customer service for additional information.

[Return to Top](#)

# Power Supplies

## Termination Options

<u>Series</u>	<u>Description</u>
100	4 Position Circular Connector
200	3 Position Mini Din Plug
300	4 Position Circular Connector for Toshiba Cameras
400	6 Position Circular Connector for Hitachi and Elmo Cameras
500	3 Position Tajimi Connector for Hitachi Cameras
600	6 Position Circular Connector for Costar and JAI Cameras
601	6 Position Circular Connector for Dalsa Cameras (To determine proper series, provide customer service with Dalsa Camera model number.)
650	
700	8 Position Mini Din Plug
800	3 Position Circular Connector for Hitachi Cameras
900	9 Position D-Subminiature for Dalsa Cameras
950	4 Position Neutrix Connector
1000	3 Position Switchcraft
3200	9 Position D-Subminiature for Costar Cameras
SL	Spade Lugs
SP	12 Position Circular Connector for Monochrome Cameras
XC	12 Position Circular Connector for Color Cameras



## Video Breakout Options

Most assemblies are also available with BNC or S-Video breakouts. Please contact customer service for additional details.

## Ordering Information

Transformer Unit    Series\*    Length in feet\*\*

\* See Page 52

\*\* 6ft, 10ft, 15ft standard



[Return to Top](#)

## Custom Capabilities

Intercon 1 offers custom cable capabilities for a wide variety of industries and applications. We have the resources to bring your new project through from design assistance to production. Our in house R&D allows us to identify the best solution for unique requirements.



Intercon 1 understands that time is of the essence for new projects. When using standard stock components, we are often able to provide custom first articles for your approval within 3-5 days.

In addition to custom assemblies, we offer custom bulk cables including jacket variations, shielding variations, and custom conductor counts and styles. Cables are also available for flexing and torsion applications.



We also offer the benefits of custom mold tooling including solid works design capabilities.

Our in house machine shop provides the ability for us to quickly modify connectors or backshells when necessary.

- Custom bulk cable
- Custom mold tools
- Design assistance
- Low Smoke/ Halogen Free
- Water tight
- Medical grade
- Military style
- Custom power supplies



## Major Tooling

Molex	Hirose	Acon
Amp	Military	Honda
3M	Amphenol	Solder

## Major Test Equipment

High Point  
Continuity  
Resistance  
Digital Sampling Oscilloscope with TDR modules  
High Frequency Signal Generator



[Return to Top](#)

# Reference Section

## Conductors

There are many components in a cable that are important to consider when specifying a cable. Besides the outer jacket, there are: [conductors](#), [insulations](#), [fillers](#), [binders](#), [identification](#), and [shields](#). While some cables are designed for specific applications, others may give acceptable performance for general use. [To determine durability and flex-life of a cable, it is important to understand cable construction.](#) If you are unsure please consult our customer service professionals. [This way, you may avoid repetitive and unnecessary cable replacements.](#) Here are some basic features to keep in mind.

## Conductors

Conductors come in various gages and construction. Although there are many materials used in conductors, copper and aluminum are the two most common. Copper has better conductivity, but in larger gages it becomes less cost effective to use. Stranded construction is most commonly used because of its better flexibility.

## Insulations

Insulations come in many different materials. Many will work in most applications while others are specific to the environment it will be used in. Be sure to reference the typical insulation characteristics in this catalog.

## Fillers

Fillers are generally used for adding strength, creating and maintaining a sequence within the cable, and filling gaps for a more uniform round appearance.

### Types of fillers

- **Cotton or Rayon** is most commonly used because of the relatively low cost.
- **Paper** is mainly used in power cables because of the ability to get it in flame and moisture resistant properties.
- **Polypropylene** is fairly common with its ability to mold to the shape of gap to be filled.
- **Solid Plastic** is sometimes used because it can be extruded in any shape or diameter.
- **Kevlar** is usually used when strength is important. It has an excellent longitudinal strength but can be expensive to use. This is normally used in fiber optic applications.

## Binders

Binders are generally used to bundle specific conductors or isolate certain conductors and shields. The most common used material is nylon and textile.

### Types of binders

- **Nylon/textile** is usually used when flexibility of a cable is required. These can be braided or wrapped.
- **Tapes** are generally a type of plastic like polyester or polypropylene.

## Identification

Identification can be used to identify: manufacturer, cable type, UL/CSA certification, temp, volt, or fire rating, as well as others. Most companies refer to this information as the 'legend'. The five most used methods in identification are explained below.

### Types of identification

- **ID Threads** – Each manufacturing company has identification threads which can be placed inside the cable should the need arise to identify the manufacturer.
- **Surface Ink** - This is when the information is inked on the surface of the jacket.
- **Sequential Printing** – This method prints an ascending numerical number usually every foot.
- **Indent Printing** – An impression of the information is put on the cable jacket.
- **Embossed Legend** – This is when the manufacturer will have raised lettering on the jacket. This is not common as this procedure is a more expensive operation.

[Return to Top](#)

## Shielding

Shielding provides an efficient way to manage electromagnetic interference. When a shielded cable is present in an ambient electromagnetic field, interference current is induced in the shield. The incident energy is partially reflected from the shield and partially absorbed by the shield, and a small amount penetrates through the shield into the cable. The small amount of energy that makes it all the way through the shield generates an interference voltage in the signal carrying conductors of the cable. The smaller the interference voltage, the better the shield is working.

In addition to shielding effectiveness, electronic cable shields must satisfy a long list of electrical, mechanical, chemical, and cost requirements. As a result, a diversified line of shield designs has evolved in the wire and cable industry.

There are three general types of common shielding.

## Braided

Braided is the most common method of shielding. It is comprised of interweaving layers of individual metal strands over cable or insulated conductors. Its consistent coverage remains so as the cable is flexed. The braiding material is normally a metal such as copper or aluminum but can also be other types of material plated with a conductive material. Typical wire size used is 32 to 40 AWG. Braid coverage can range from 70% to 95%. Generally more coverage equals better shielding. This type of shielding is ideal for minimizing low frequency interference and has a lower DC resistance than that of foil shielding. General uses for this type of shielding are low speed communication, good mechanical strength, or when increased flex life is needed. Drawbacks of the braided shield include high manufacturing costs due to the relatively slow speed at which the shield-braiding machinery forms the braid. Braided shields are usually bulkier, heavier and in some cases it may be harder to terminate because the braid has to be either combed out and pig tailed or combed out equally around the OD of the cable.

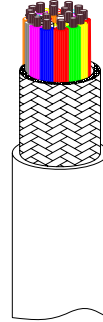

## Foil

Foil can be constructed in single layer aluminum, conductive nylon, or two layers of aluminum with polyester backing. These types of shields are generally used for individually shielding multi-pair data cables. Foil shielding is the only commonly available shield that can give you 100% coverage. Although it is cheap, it severely limits flexibility and indeed breaks down under repeated flexing. Drain wires are normally used with this type of shield to make termination easier. Although this cable is generally more flexible than braided, it has a much shorter flex life because of its thin mechanical strength and the possibility of separation. Twisting of the conductor pairs with foil shielding can reduce cross talk, which provides the best electrical isolation between adjacent pairs.

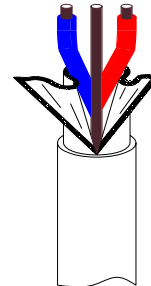

## Spiral/Serve

Spiral/Serve consists of 32 to 40 AWG copper strands (bare or tinned) in a helical shape around the cable or insulated conductors in a flat ribbon configuration. This type of shielding can give you up to 97 percent coverage. The advantage of this type of shielding is its superior flexibility, flex life, and ease of termination. Although it does not have the tensile strength of braid, the benefits are less copper, much faster to manufacturer, and can give you a smaller cable diameter. Generally spiral shields are not used above audio frequencies because of coil effect produced by the inductance or retractile cables.

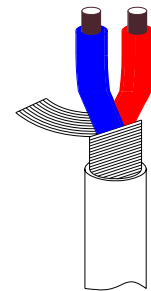

[Return to Top](#)



# Fire / Flame Tests and Ratings

Customers of wire and cable should be aware of the latest regulations and the products that meet these standards. Many tests have been developed to measure the flame resistance of wire and cable products. Flame resistance of a cable is frequently defined as the ability to stop burning once the source of heat is removed. Here is a brief summary of the most widely used North American fire tests and ratings.

## Vertical Tray Flame Test

### UL 1581 / IEEE 383

This test is performed on cables attached to a 1ft wide and 8 ft tall vertical metal ladder tray. The source of combustion is a 10 inch ribbon burner with an air/propane mixture which will supply approximately 70,000 BTU's per hour. The flame is applied for 20 minutes, 24 inches from the bottom of the cable. This rating requires the cable to self-extinguish prior to reaching the top of the tray.

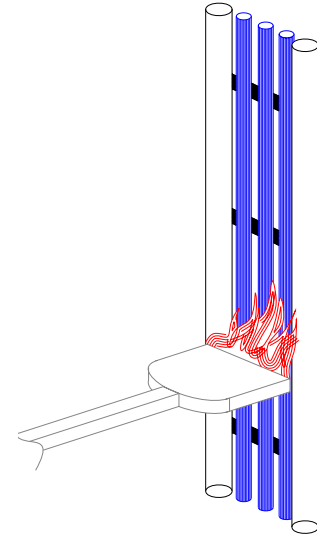

### CSA FT-4

This test is a later generation of the IEEE 383 test and is generally considered more stringent. To pass this test the resulting char distance must not be greater than 1.5 meters.

### IEEE 1202

The IEEE 1202 flame test is the newest version of the original IEEE 383 Flame Test. It is practically identical to the CSA FT-4 test

### UL 1685

The UL 1685 is fundamentally the UL 1581 test with smoke emission requirements. A cable passing this test can be given a 'Limited Smoke listing'.

### ICEA T-29-520

This is another variation of the UL 1581 / IEEE 383 except the BTU value is 210,000 instead of 70,000 and cable spacing increases.

## Vertical-Wire Flame Test

### UL 1581 VW-1

This was the first flame test developed for studying flame spread on wire and cable. The test is performed with a 24 inch wire or cable and a Tirrill burner. Two clamps hold the single sample vertically. The burner is mounted at a 20° angle and the inner flame can touch the samples surface. Flame is applied for 15 seconds and is then reapplied 4 more times each time the wire ceases to burn. If the sample does not burn longer than 60 seconds after any application, or if less than 25% of the indicator flag burns, or the cotton batting is ignited during the test, the cable passes. A "tray rated" cable must meet this test as well.

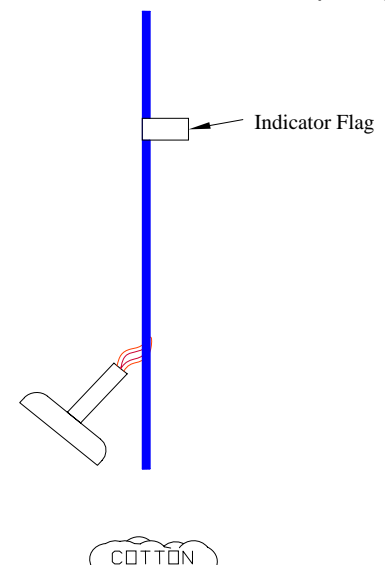

### CSA FT-1

This is the Canadian version of the VW-1 test.

[Return to Top](#)

## Reliability Tests for 4 basic kinds of flexing

High performance cable should be considered when specifying a cable for automation. Conductors under constant motion can break due to heat generated from friction. Just because a cable is very flexible does not mean it will have a long life. In some cases, a more rigid outer cable jacket allows the conductors to move more freely inside resulting in less friction. The outer jacket not only needs to withstand constant flexing but provide protection against mechanical abrasion and environmental conditions like: chemical, moisture, and temperature. If the cables components have been designed for increased flexibility, jacket material can be determined respective to these environmental conditions. There are four basic types of flexing that most cables experience, they are: Bending, Rolling, Torsional, and Variable. These tests are basic guidelines to help with cable design associated to its function. Many cable manufactures have specific testing for their products. These examples are meant for a general understanding of basic flex testing

### Bend

Bend flexing is when the cable is flexed back and forth in one general place. This can come from many applications. Motion cameras are a very popular in this type of flexing. The cable is usually stationary while just behind the camera the cable will flex at the same place every time. This type of test is commonly referred to as "Tick Tock test" and "Flex test".

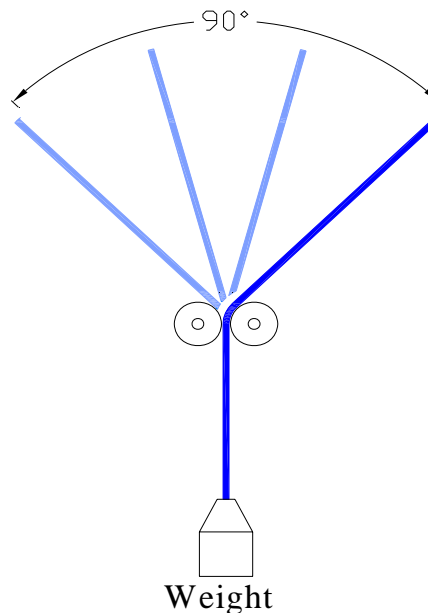

## Bend testing guidelines

The cable is affixed to a pendulum type device and weighted. The amount of weight and size of the bend radii is dependant on the size of cable and its inner conductors. Every conductor is monitored and in the event of a failure, the test automatically stops. The cable is then flexed back and forth and counted until there is a failure within the cable.

[Return to Top](#)

## Roll

Roll flexing is most common in automated equipment. The cable is harnessed in a flexible cable track and moved in a linear direction. This type of application will usually have an abrasion resistant jacket because of the constant rubbing against other wires, cables as well as the cable track itself. It is important to specify the correct cable to the bend radius of the cable track. A larger radius on the cable track can result in longer cable life.

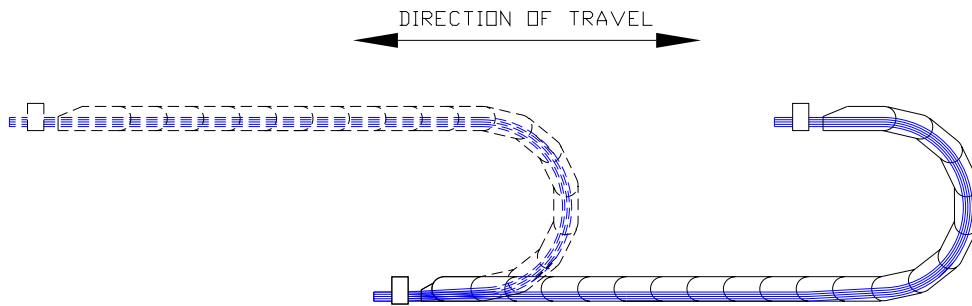

## Roll testing guidelines

The cable is installed and anchored within the cable track. Every conductor is monitored and in the event of failure, the test will stop. The cable track will be operated back and forth and counted until there is a failure within the cable.

## Torsional

Torsional flexing is when a cable twists around its axis'. This is common to robotic applications and hand held devices with a cord. It is one of the more demanding mechanical stresses. The strain created by the twisting motion is different than that of a bend or roll flex. Because of this, standard high flex cables may not be suitable for these applications. For maximum performance, a cable designed specifically for torsion should be utilized.

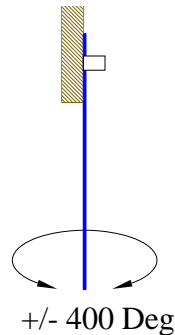

## Torsional testing guidelines

The cable is anchored to a surface and then twisted 400 degrees in each direction from its relaxed state. Test requirements may change slightly for cable design and function. Some alterations may include: adding weight, length of cable, or amount of twist. Every conductor is monitored and in the event of failure the test will stop.

[Return to Top](#)

## Variable

Variable flexing is when the cable is fixed in two positions and has the freedom to bend and move in any direction. This is usually found in robotic applications. With this freedom of movement, cable selection is critical.

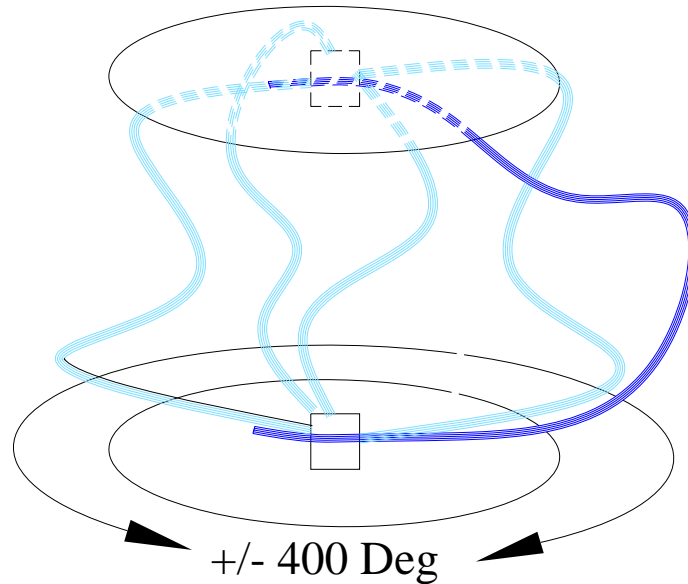

## Variable testing guidelines

The cable is anchored in two separate places and then one end is rotated 400 degrees in each direction from its relaxed state. Test requirements may change slightly for specific cable design. Some alterations may include: length of cable or amount of twist. Every conductor is monitored and in the event of failure the test will stop.

---

### General guidelines

Consider the applications voltage, current, bend radius, physical location, environmental conditions, and flex cycle when choosing a cable. This can increase the life cycle which results in less downtime and longer maintenance intervals.

When troubleshooting a deteriorated cable, there are a few general things to look for.

**Twisted Cable Jacket-** The outside jacket generally starts to twist when the internal conductors have begun to unwind due to improper cable selection, installation, or shielding

**Outer Jacket Wear-** Many times this is due to incorrect cable selection or installation. If the cable can contact any other surface while in motion, it will give opportunity for abrasion wear.

**General Cable Failure-** This happens most often because of harsh environmental conditions. The introduction to hazards like: moisture, welding spatter, oils, chemicals, temperature, and sunlight can degrade a cable assembly prematurely if it is not specified for the correct conditions.

[Return to Top](#)

# Installation Data for High-Flex Cable in a Cable Track

When selecting cable for cable track the following criteria should be taken into consideration:

## Environmental Conditions

Different materials are designed for different environmental conditions. The following list is some of the most common environmental conditions to be considered:

- Abrasives
- Acids
- Alcohols
- Alkali'
- Cold/Hot Temperatures
- Flame
- Indoor/Outdoor use
- Moisture
- Petroleum Products/Gasoline
- Oxidation
- Oils
- Ozone
- Sunlight

## Other Factors to Consider

- Traveling Speed and Distance
- Frequency of Operation
- Minimum Bend Radius
- Shielding

## Successful installation will greatly increase by following these guidelines:

1. Do not exceed the recommended minimum bend radius of the cable. This is based on a general application at a normal operating temperature. Many times a larger bend radius than the minimum will increase the service life of the cable.
2. Prepare the cable for torsion-free installation without twists, bends or kinks. Always unwind the cable from the outside layer of the reel or spool. Never pull a cable from a coil. Lay out the cable or hang it for 24 hours prior to installation. This will relax any remaining stresses resulting from production, transit, or storage. If the cable cannot be unstressed and still maintains a 'coil memory', shake it out by grasping the cable at its middle and vigorously shake the cable as you move to each end.
3. Once the cable is ready, wrap each end of the cable with non-residue producing identification tape and indicate the top of each cable end. Maintain this alignment throughout installation. This reduces the possibility of twist in the cable during installation.
4. Evaluate the weight and size of each cable. The cables, by weight, must be evenly distributed in the track. Place the heavier cables toward the outside of the track and the lighter ones toward the center. For a cable track that is side mounted, always place the larger cables toward the outside and the smaller cables toward the inside of the track.

[Return to Top](#)

5. Place the cables in the track in a 'working position' and loosely side by side. As a rule, allow at least 10% more of the cables diameter within the internal dimensions of the cable track. Do not weave the cables between or around other cables in the track. If spacers are provided in the track, separate the larger cables from smaller cables.

**Important** - Cables must not push tightly against the inner or outer curve of the track and never fasten cables to the track or each other.

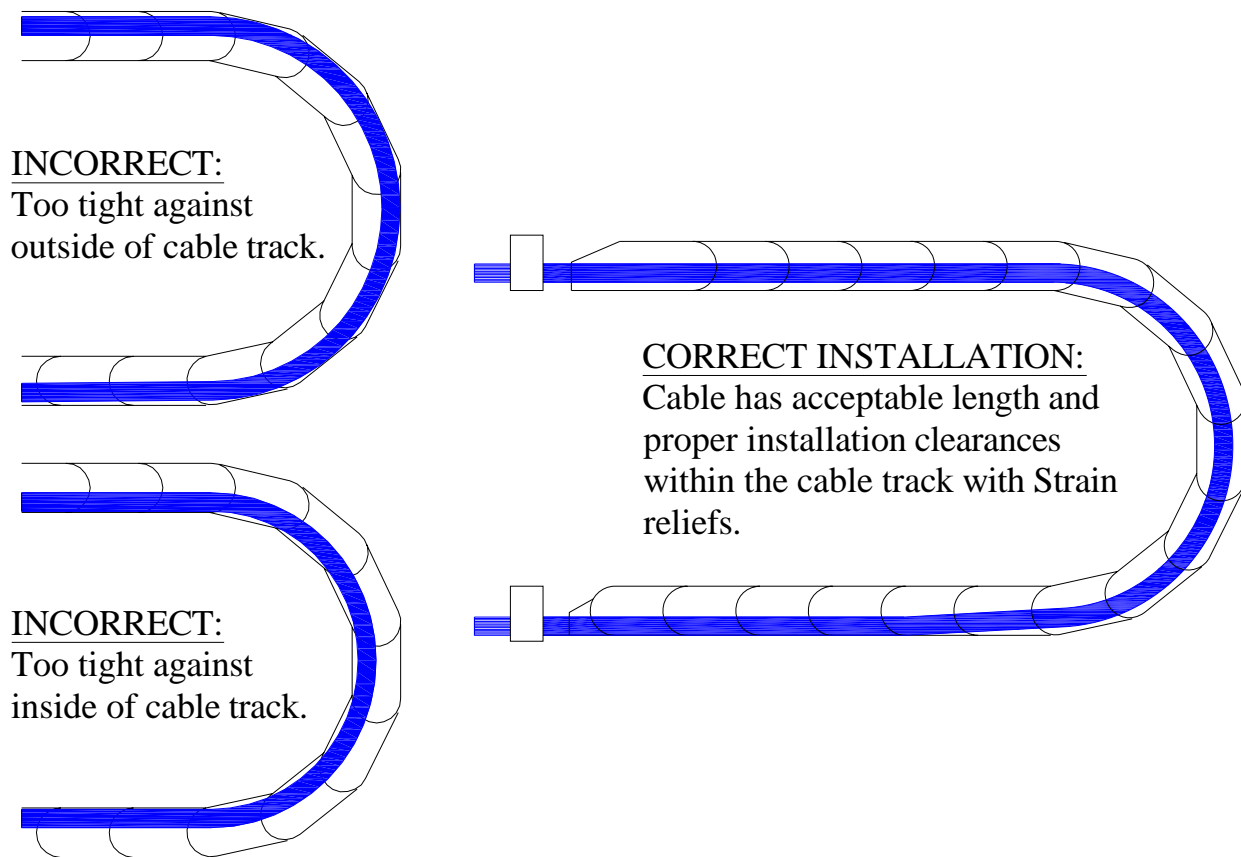

6. Locate the proper attachment points for saddle clamps and affix at both ends of the cable track. Do not over tighten. The purpose for saddle clamps is to distribute the pressure evenly over a larger area of the jacket which reduces the possibility of crushing the conductors.
7. After the cable is installed, it should be cycled through several flex operations. During these initial flex operations observe cable movement and check for freedom from binding, rubbing, and pulling. It is critical that all cables move with complete freedom, throughout the cable track.

[Return to Top](#)

# Index



<http://www.intercon-1.com>

## Index

<u>PART NUMBER</u>	<u>PAGE</u>	<u>PART NUMBER</u>	<u>PAGE</u>
<a href="#">ABOUT US 1</a>	2	<a href="#">POMCLP-xx-P</a>	30
<a href="#">ABOUT US 2</a>	3	<a href="#">POMCLP-xx-MP</a>	31
<a href="#">BVCP-xx-P</a>	4	<a href="#">F-GEVPT-xx-P</a>	32
<a href="#">SVCP-xx-P</a>	5	<a href="#">F-GEVVPT-xx-P</a>	33
<a href="#">SVCP*-xx-P</a>	6	<a href="#">F-GEVP-xx-P</a>	34
<a href="#">MCS-xx-P</a>	7	<a href="#">MIDAP-xx-PA</a>	35
<a href="#">MVCP-xx-S</a>	8	<a href="#">MIDAP-xx-PB</a>	36
<a href="#">PVCS-xx-P</a>	9	<a href="#">MIDBP-xx-PB</a>	37
<a href="#">VCP-xx-S</a>	10	<a href="#">IF-MIDAPC-xx-PAC</a>	38
<a href="#">VCS*-xx-P</a>	11	<a href="#">IF-MIDAPT-xx-PAT</a>	39
<a href="#">VCS*2-xx-P</a>	12	<a href="#">IF-MIDAP-xx-PA</a>	40
<a href="#">VCXS-xx-PJB</a>	13	<a href="#">F-FWBPT-xx-PA6</a>	41
<a href="#">VCS-xx-B*</a>	14	<a href="#">F-FWBPT-xx-PB</a>	42
<a href="#">CLCP-xx-P</a>	15	<a href="#">F-FWBPT-xx-PBT</a>	43
<a href="#">CLCP*-xx-P</a>	16	<a href="#">IF-B2PA-xx-PA</a>	44
<a href="#">CLCP-xx-PLx</a>	17	<a href="#">GPIO-xx-PS</a>	45
<a href="#">CLCP-xx-R</a>	18	<a href="#">RHC*P-**-P</a>	46
<a href="#">IF-CLCP-xx-P</a>	19	<a href="#">WIPS-xxx-xx</a>	47
<a href="#">CLFP*-xx-R</a>	20	<a href="#">PSI-xxx-xx</a>	48
<a href="#">CLCP3-xx-P3</a>	21	<a href="#">DPS-xxx-xx</a>	49
<a href="#">CLOL-xxx*</a>	22	<a href="#">IPS-xxx-xx</a>	50
<a href="#">ECLP-xx-P</a>	23	<a href="#">Termination options</a>	51
<a href="#">MCLCP-xx-MP</a>	24	<a href="#">Custom Capabilities</a>	52
<a href="#">MCLCP-xx-P</a>	25	<a href="#">Cable Guide</a>	54
<a href="#">MCLCP*-xx-MP</a>	26	<a href="#">Fire/Flame Tests and Ratings</a>	56
<a href="#">POCL-xx-P</a>	27	<a href="#">Flex Testing</a>	57
<a href="#">POCLP*-xx-P</a>	28	<a href="#">Cable Track Installation</a>	60
<a href="#">POCLP-xx-PL</a>	29	<a href="#">Index</a>	

Custom variations available. Please contact customer service for additional information.

**Intercon 1** A Division of Nortech Systems, Inc. - 7746 Goedderz Road - Baxter, MN USA 56425  
P 218.828.3157 - Toll Free in US 800.237.9576 - FAX 218.828.1096 - [intercon@nortechsys.com](mailto:intercon@nortechsys.com)

