



Planar T* 1,4/50 ZF



Features

- Fast f/1.4 aperture
- Precise manual focusing
- Robust full-metal construction
- Identical color reproduction of all models
- For industrial cameras with F-Mount up to sensor sizes of 24x36 mm or 43mm line sensors.

ZF-I: Industrial Edition

Features special screws to fix focus and aperture settings even in rough situations.

ZF-IR: Infrared Edition

Features special coating for optimized performance in near-infrared applications.

Camera Mounts

Available for other camera mounts such as EF, or M42 screw mount.



Planar T* 1,4/50 ZF

Technical Specifications

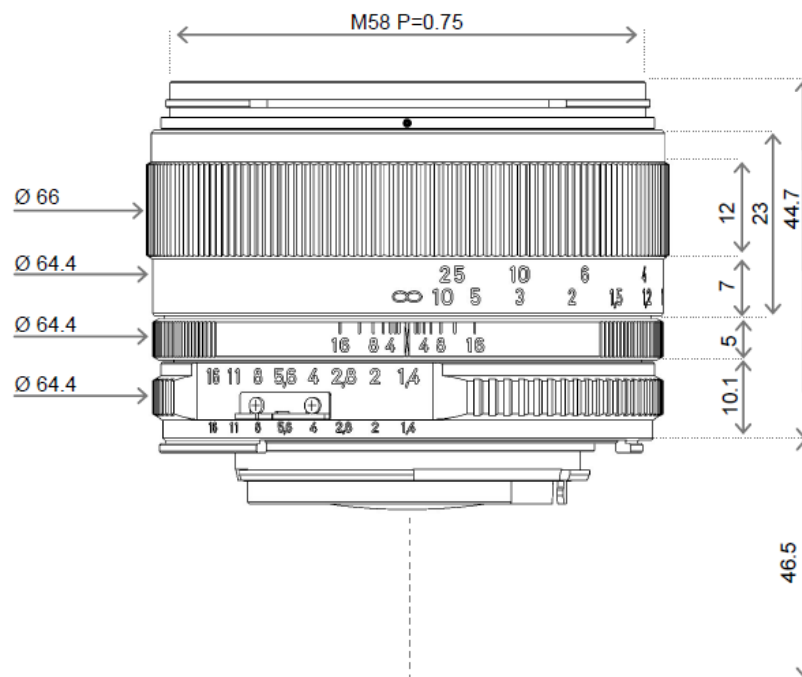

Focal length	50 mm
Aperture range	f/1.4 – f/16 (1/ 2 stop intervals)
Number of elements / groups	7 / 6
Min. working distance (object to sensor)	450 mm (1.48 ft.) – ∞
Min. free working distance	351mm (1.15 ft.) – ∞
Angular field* (diag. / horiz. / vert.)	45 / 38 / 26 °
Max. diameter of image field	43 mm (1.7")
Flange focal length	F-Mount: 46.5 mm (1.8"); M42-Mount: 45,5 mm
Coverage at close range	160 x 240 mm (6.3 x 9.4"), line 288 mm (11")
Image ratio at close range	1:6.7
Filter-thread	M 58 x 0.75
Weight	330 g (0.66 lbs.)
Camera mount	F bayonet, M42, EF

* referring to 35 mm format



Planar T* 1,4/50 ZF

Relative Illuminance*

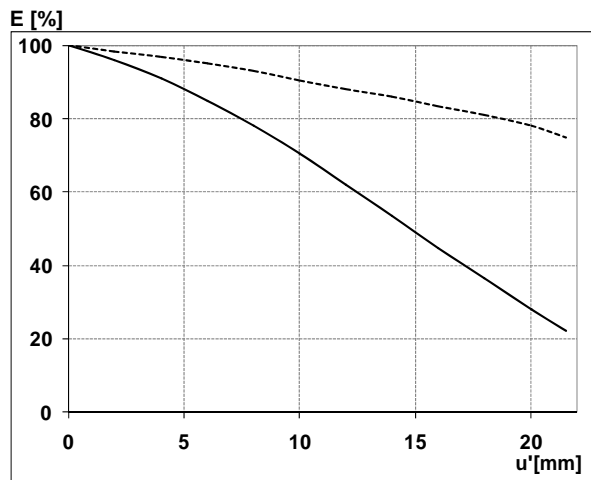

The relative illumination shows the decrease in image brightness from the image center to the edge in percent.

— f-number 1.4
... f-number 4

Relative Distortion*

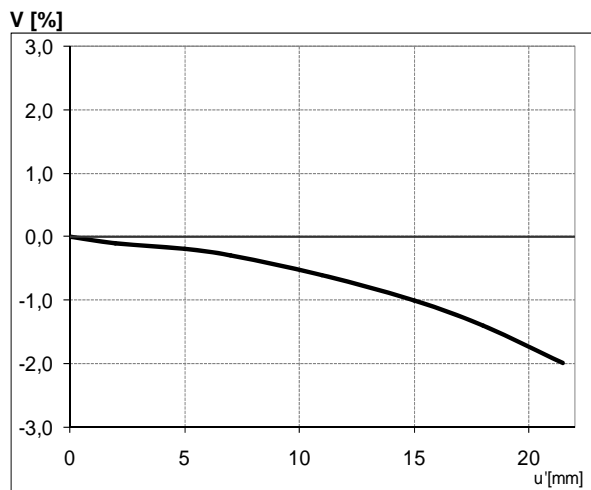

The relative distortion shows the deviation of the actual image height from the ideal one in percent.

*Data for infinite focus setting



Planar T* 1,4/50 ZF

MTF Charts*

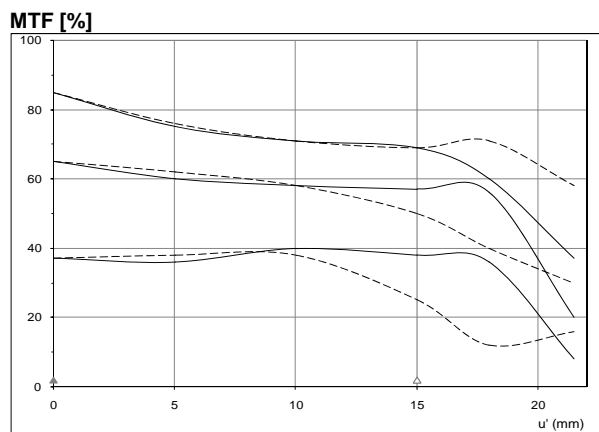

The Modulation Transfer (MTF) as a function of image height (u) and slit orientation (sagittal, tangential) has been measured with white light at spatial frequencies of $R = 10, 20$ and 40 cycles/mm. The MTF charts are valid for the ZF, ZF-I version and for white light.

f-number 1.4
— Saggital
... Tangential

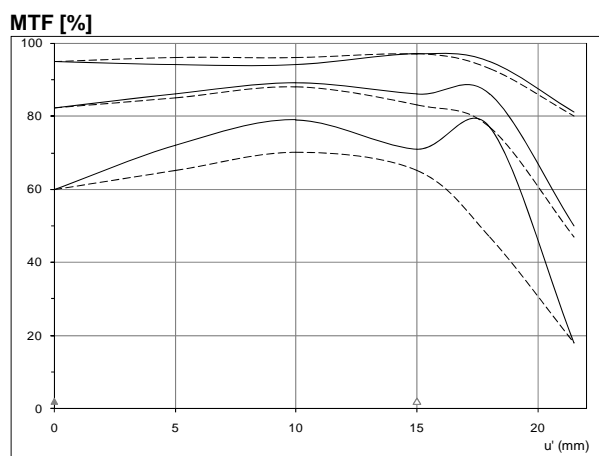

f-number 4
— Saggital
... Tangential

*Data for infinite focus setting / Not for IR version



Planar T* 1,4/50 ZF

Spectral Transmission ZF vs. ZF-IR

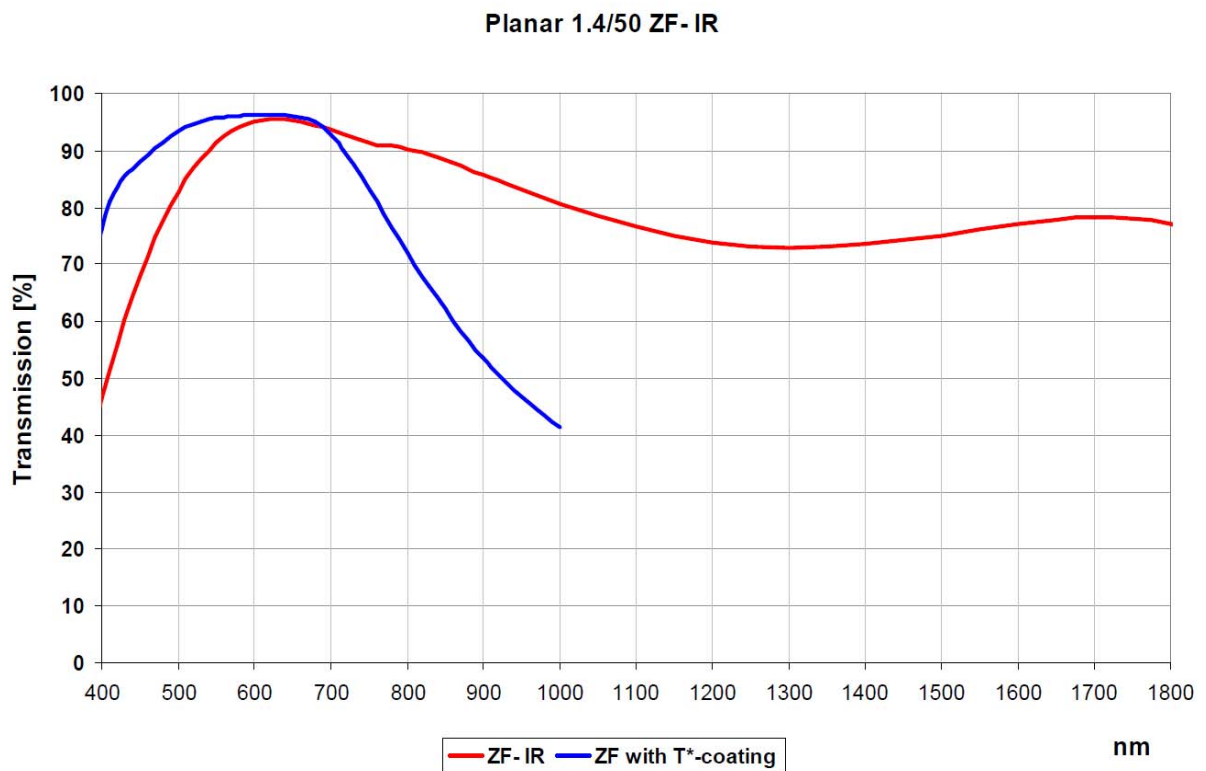



Planar T* 1,4/50 ZF

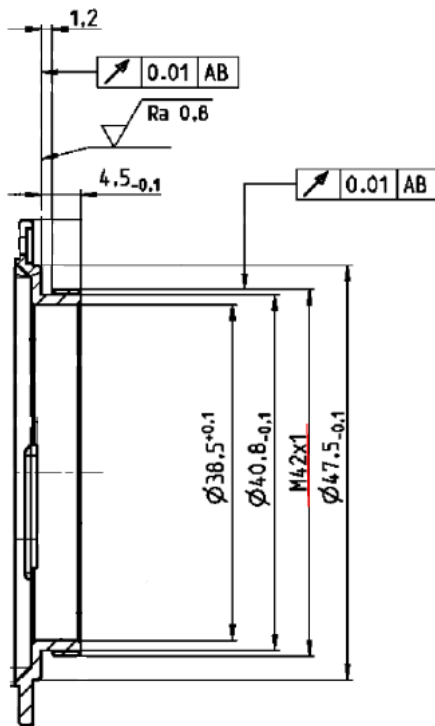

M42 Mount for 45,5 mm Flange Focal Distance

The diameter of the camera/lens adapter must not exceed 55 mm at the lens side!

