

VL5024U-MPZ

f=50mm F2.4

**for 1 Type 20Megapixel cameras, Motorized Control Fixed-focal
USB interface, C-Mount**

Optical Specifications

Model No.		VL5024U-MPZ		Effective Lens Aperture		Front:φ21.8mm Rear:φ16.4mm	
Focal Length		50mm		Back Focal Length		11.1mm (in Air)	
Operation Range	Iris	F2.4 - F16.0		Flange Back Length		17.526mm (In Air)	
	Focus	0.2m - Inf.		Max. Image Format		12.8mm x 9.6mm(φ16mm)	
Object Dimension at M.O.D.	1 Type	41.0mm x 30.7mm		Distortion	1 Type	0.0%	
	2/3 Type	28.1mm x 21.1mm			2/3 Type	0.0%	
	1/1.8 Type	23.0mm x 17.2mm			1/1.8 Type	0.0%	
Angle of View	D	1 Type	18.2°	2/3 Type	12.6°	1/1.8 Type	10.3°
	H		14.6°		10.1°		8.3°
	V		11.0°		7.6°		6.2°

Mechanical & Electrical Specifications

Control Interface		USB2.0		Dimensions		As per the attached drawing	
Power mode		Bus powerd (500mA)		Mount		C-Mount	
Connector		USB TypeA		Weight		326g	
Operating Temperature		-10°C - +50°C		Tripod Screw		-	
Control	Iris	Motorized		Filter thread		M43 x P0.75mm	
	Focus	Motorized					

Dimensions

Unit:mm

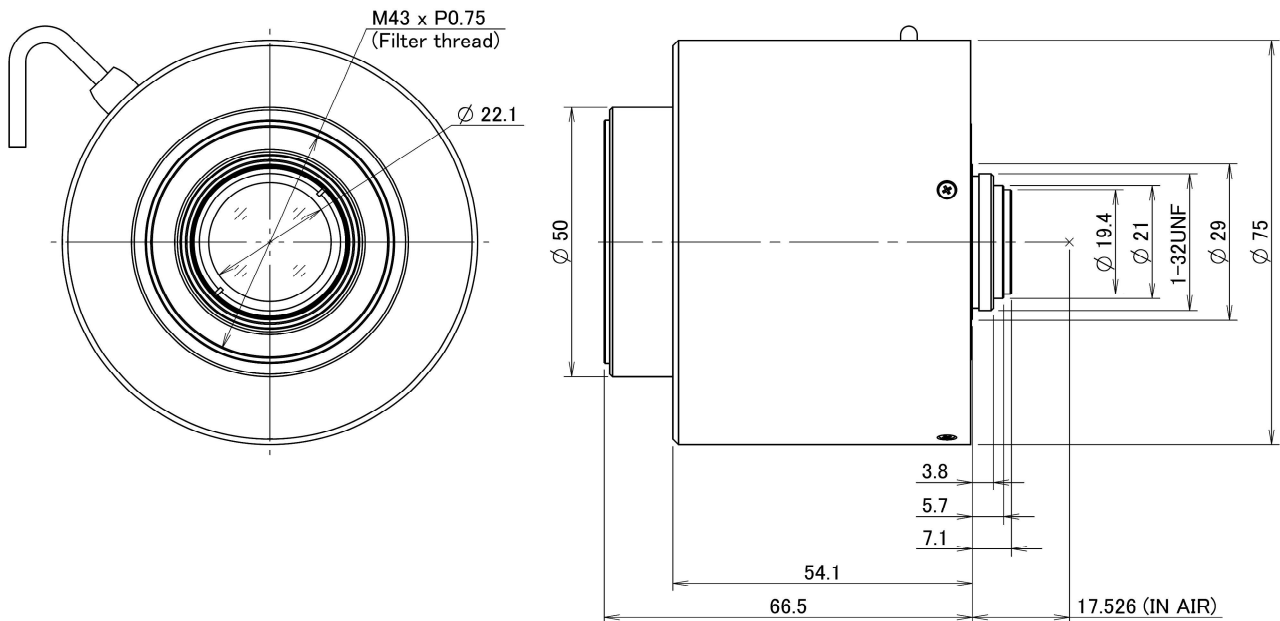

Length of Wire

300±20 (mm)

This specification is subject to change without any notice.



945 East 11th Avenue Tampa, FL 33605

Phone: (813) 984-0125

Contact: Sales@pyramidimaging.com

<https://pyramidimaging.com>