

REVISIONS				
REV.	DESCRIPTION	DATE	APPROVED	
A	INITIAL RELEASE	5/8/2013		
B	CHANGED VIEW ON SHEET 3	5/8/2013		
C	ADDED DUST COVERS AND ADDITIONAL SCREWS	5/26/2013		

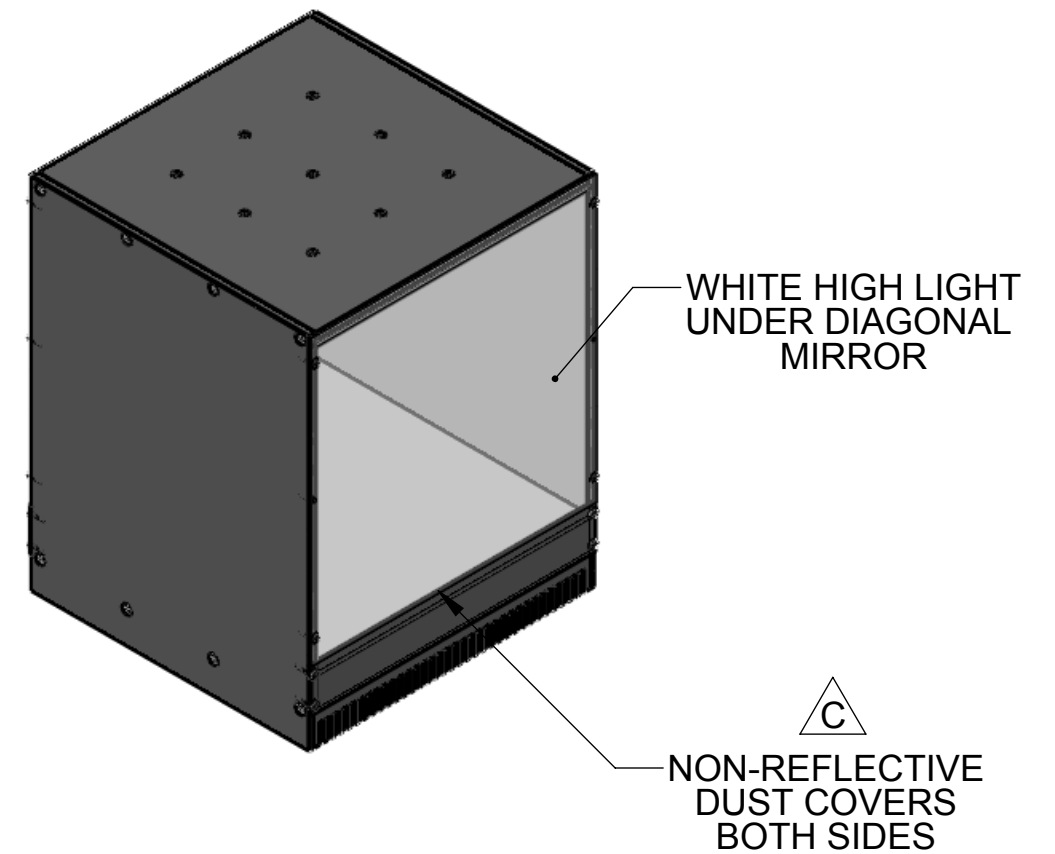

APPROVED
By Kevin High at 8:22 am, Jun 13, 2013

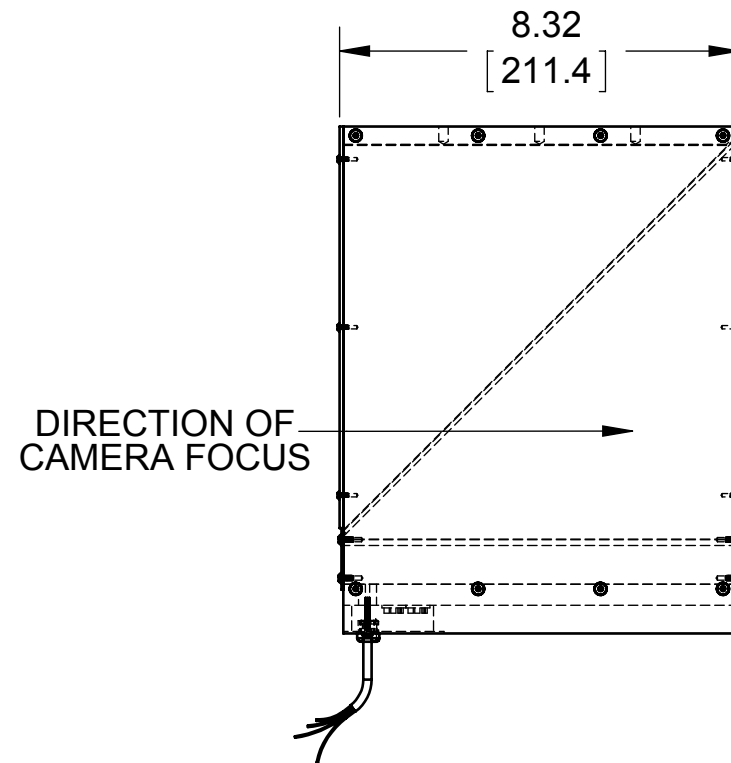
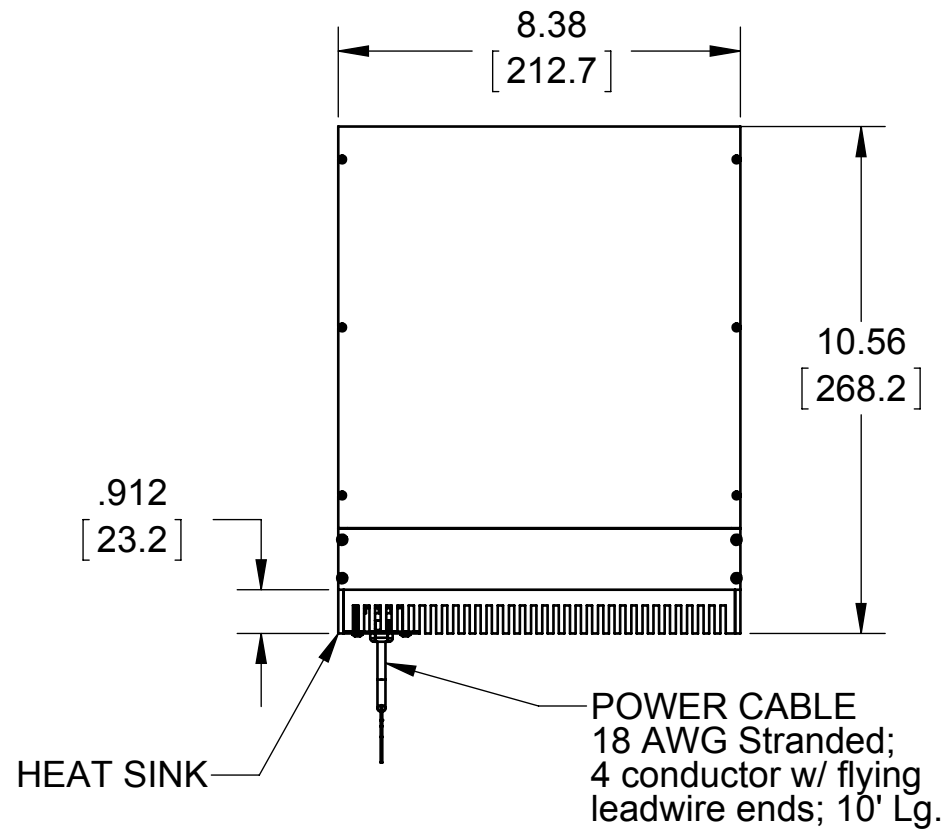

945 East 11th Avenue Tampa, FL 33605

Phone: (813) 984-0125

Contact: Sales@pyramidimaging.com

<https://pyramidimaging.com>