

High Resolution 2/3" Fixed-Focal
GM33519MCN

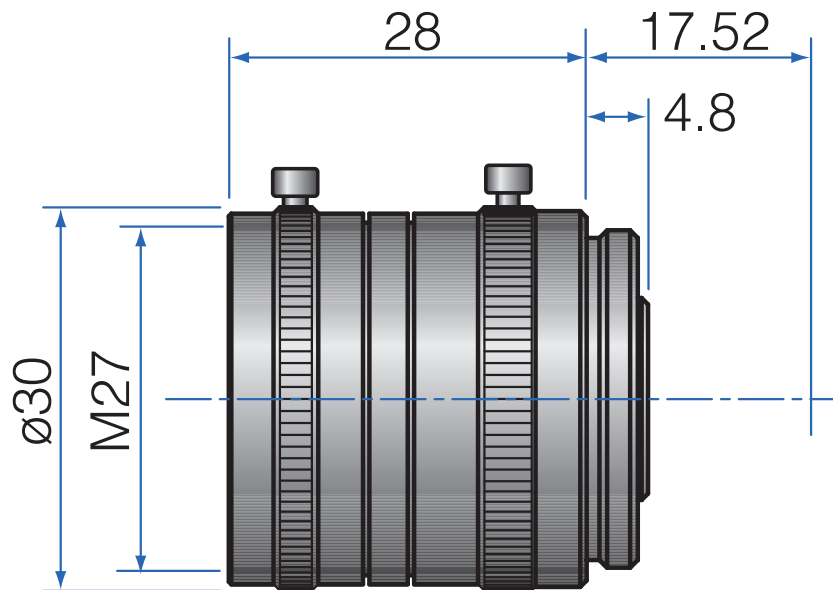

Part No.	GM33519MCN
Focal Length	35mm
Iris Range	f/1.9-Close
Lens Format	2/3"
Resolution	100 lp/mm
MOD	500mm
Mount	C
Filter Thread	M27xP0.5
Angle of View (HxVxD) 1/2"	10.5° x 7.9° x 13.1°
Angle of View (HxVxD) 2/3"	14.4° x 10.8° x 17.9°
Weight	50g
Dimension (DxL)	Ø30 x 28.0



945 East 11th Avenue Tampa, FL 33605

Phone: (813) 984-0125

Contact: Sales@pyramidimaging.com

<https://pyramidimaging.com>