

## High Resolution 2/3" Fixed-Focal GM37527MCN

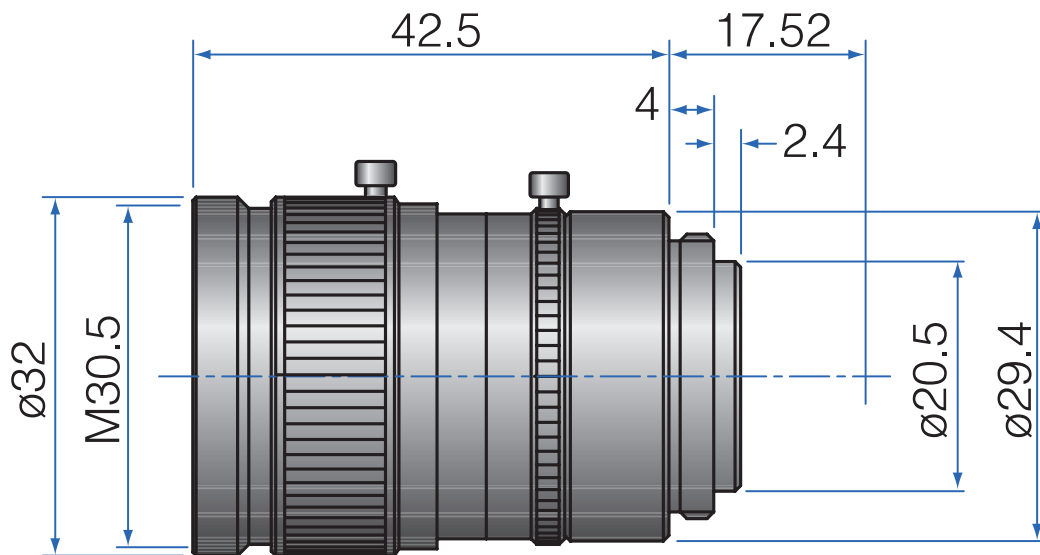

Part No.	GM37527MCN
Focal Length	75mm
Iris Range	f/2.7-Close
Lens Format	2/3"
Resolution	100 lp/mm
MOD	1000mm
Mount	C
Filter Thread	M30.5xP0.5
Angle of View (HxVxD) 1/2"	4.46° x 3.34° x 5.58°
Angle of View (HxVxD) 2/3"	6.33° x 4.55° x 8.12°
Weight	55g
Dimension (DxL)	Ø32 x 42.5