

High Resolution 2/3" Fixed-Focal
GMN32516MCN-1

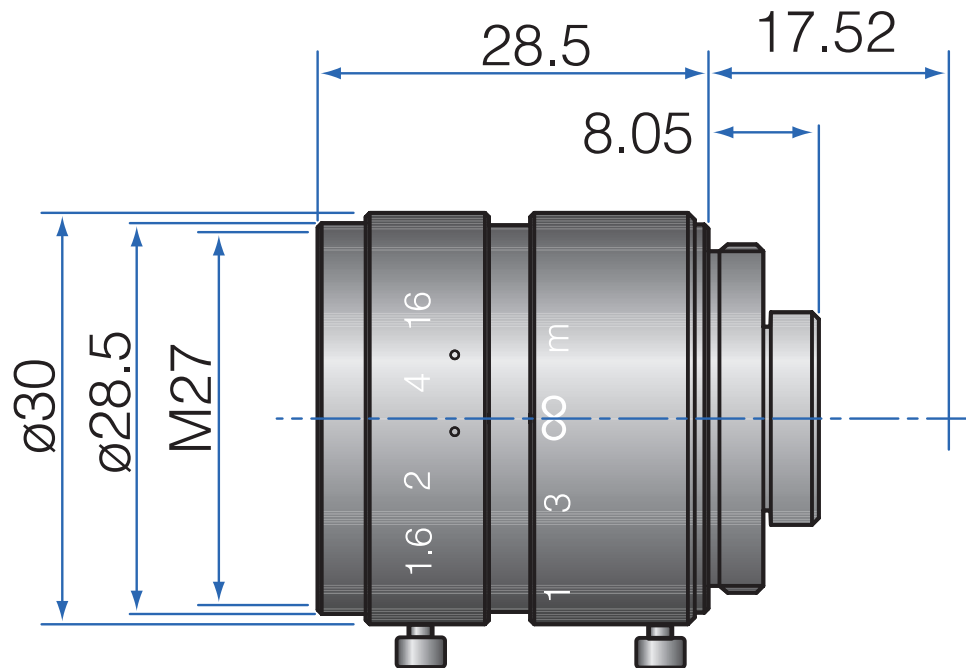

Part No.	GMN32516MCN-1
Focal Length	25mm
Iris Range	f/1.6-16
Lens Format	2/3"
Resolution	100 lp/mm
MOD	200mm
Mount	C
Filter Thread	M27xP0.5
Angle of View (HxVxD) 1/2"	15.3° x 11.4° x 19.1°
Angle of View (HxVxD) 2/3"	21.0° x 15.7° x 26.3°
Weight	50g
Dimension (DxL)	Ø30 x 28.5