

5 MP 2/3" Fixed-Focal

## GMR5HR33516MCN

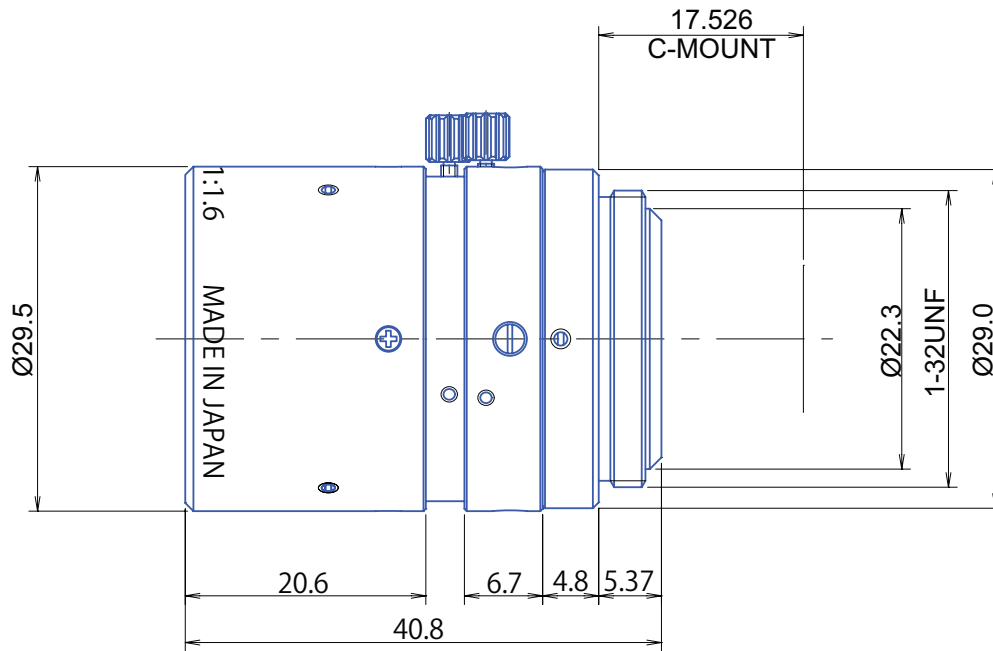

Part No.	GMR5HR33516MCN
Focal Length	35mm
Iris Range	f/1.6-16
Lens Format	2/3"
Resolution	160 lp/mm
MOD	350mm
Mount	C
Filter Thread	M27 x P0.5
Angle of View (HxVxD) 2/3"	14°74' x 11°08' x 18°37'
Weight	65g
Dimension (DxL)	Ø29.5 x 40.8