

Genie Nano Series™

Camera User's Manual

1 Gb GigE Vision – Monochrome & Color Area Scan

sensors | cameras | frame grabbers | processors | software | vision solutions



March 07, 2018
Rev: 0020
P/N: G3-G00M-USR00
<https://pyramidimaging.com>



Notice

© 2015-2018 Teledyne DALSA

All information provided in this manual is believed to be accurate and reliable. No responsibility is assumed by Teledyne DALSA for its use. Teledyne DALSA reserves the right to make changes to this information without notice. Reproduction of this manual in whole or in part, by any means, is prohibited without prior permission having been obtained from Teledyne DALSA.

Microsoft and Windows are registered trademarks of Microsoft Corporation in the United States and other countries. Windows, Windows 7, Windows 10 are trademarks of Microsoft Corporation.

All other trademarks or intellectual property mentioned herein belong to their respective owners.

Document Date: March 7, 2018

Document Number: G3-G00M-USR00

About Teledyne DALSA

Teledyne DALSA is an international high performance semiconductor and Electronics Company that designs, develops, manufactures, and markets digital imaging products and solutions, in addition to providing wafer foundry services.

Teledyne DALSA Digital Imaging offers the widest range of machine vision components in the world. From industry-leading image sensors through powerful and sophisticated cameras, frame grabbers, vision processors and software to easy-to-use vision appliances and custom vision modules.

Contents

GENIE NANO SERIES OVERVIEW	9
DESCRIPTION	9
<i>GigE with TurboDrive</i>	9
<i>Genie Nano Overview</i>	10
<i>Camera Firmware</i>	10
MODEL PART NUMBERS	11
<i>Monochrome Cameras</i>	11
<i>Color Cameras</i>	13
<i>Accessories</i>	16
SOFTWARE REQUIREMENTS	17
<i>Sapera LT Development Software</i>	17
<i>Third Party GigE Vision Development</i>	17
<i>About GigE Vision</i>	17
GENIE NANO SPECIFICATIONS	18
COMMON SPECIFICATIONS	18
<i>Sensor Cosmetic Specifications</i>	20
Dynamic Range & Signal to Noise Ratio Measurement Conditions	20
<i>EMI, Shock and Vibration Certifications</i>	21
<i>Mean Time between Failure (MTBF)</i>	22
SONY SENSOR MODELS	23
SPECIFICATIONS: M700, C700	23
<i>Spectral Response</i>	24
<i>Firmware Files for Models M700, C700</i>	25
SPECIFICATIONS: M1450, C1450	26
<i>Spectral Response</i>	27
<i>Firmware Files for Models 1450</i>	27
SPECIFICATIONS: M1920, C1920	28
SPECIFICATIONS: M1940, C1940	29
<i>Firmware Files for 1920, 1940</i>	31
<i>Spectral Response</i>	32
SPECIFICATIONS: M2020, C2020	33
<i>Firmware Files for Models 2020</i>	34
SPECIFICATIONS: M2050	34
<i>Firmware Files for Model M2050</i>	35
SPECIFICATIONS: C2050	36
<i>Firmware Files for Model C2050</i>	37
<i>Spectral Responses</i>	38
SPECIFICATIONS: M2420, C2420	39
<i>Firmware Files for Models 2420</i>	40
SPECIFICATIONS: M2450	40
<i>Firmware Files for Model M2450</i>	41
SPECIFICATIONS: C2450	42
<i>Firmware Files for Model C2450</i>	43
<i>Spectral Responses</i>	44
SPECIFICATIONS: M4060	45

<i>Firmware Files for Model M4060</i>	46
SPECIFICATIONS: C4060	46
<i>Firmware Files for Model C4060</i>	47
SPECIFICATIONS: M4040	48
<i>Firmware Files for Model M4040</i>	49
SPECIFICATIONS: C4040	49
<i>Firmware Files for Model C4040</i>	50
<i>Spectral Responses 4060 & 4040</i>	51
SPECIFICATIONS: M4030, C4030	52
SPECIFICATIONS: M4020, C4020	53
<i>Firmware Files for Model 4030 & 4020</i>	54
<i>Spectral Response</i>	55
ON-SEMI SENSOR MODELS	56
SPECIFICATIONS: M640, M640-NIR, C640	56
SPECIFICATIONS: M800, M800-NIR, C800	57
<i>Firmware Files for Models 640, 800</i>	59
SPECIFICATIONS: M1240, C1240	59
<i>Firmware Files for Models 1240</i>	60
SPECIFICATIONS: M1280, M1280-NIR, C1280	61
SPECIFICATIONS: M1930, M1930-NIR, C1930	62
SPECIFICATIONS: M2590, M2590-NIR, C2590	64
<i>Firmware Files for Models 1280, 1930, 2590</i>	65
NANOXL SPECIFICATIONS: M5100, M5100-NIR, C5100, M4090, M4090-NIR, C4090	66
<i>Spectral Response</i>	68
<i>Defective Pixel Specification for Models 5100/4090</i>	69
<i>Firmware Files for Models 5100/4090</i>	71
SPECIFICATIONS: C4900	72
<i>Spectral Response</i>	73
<i>Supplemental Usage Notes:</i>	74
<i>Model C4900 Sensor Cosmetic Specifications</i>	74
<i>Firmware Files for This Model</i>	75
<i>Guide to Using a Rolling Shutter Camera</i>	76
Overview of Electronic Rolling Shutter (ERS) Exposures	77
Overview of Global Reset Release (GRR) Exposures	78
COMPARISON OF SIMILAR ON-SEMI AND SONY SENSORS	79
NANO QUICK START	81
TESTING NANO WITHOUT A LENS	81
TESTING NANO WITH A LENS	81
THE CAMERA WORKS — NOW WHAT	81
CONNECTING THE GENIE NANO CAMERA	82
GIGE NETWORK ADAPTER OVERVIEW	82
<i>PAUSE Frame Support</i>	82
CONNECT THE GENIE NANO CAMERA	82
<i>Connectors</i>	83
<i>LED Indicators</i>	84
Camera Status LED Indicator	84
LED States on Power Up	84
<i>Genie Nano IP Configuration Sequence</i>	85
Supported Network Configurations	85
PREVENTING OPERATIONAL FAULTS DUE TO ESD	86

USING NANO WITH SAPERA API	87
NETWORK AND COMPUTER OVERVIEW	87
INSTALLATION	88
<i>Procedure</i>	88
<i>Camera Firmware Updates</i>	88
<i>Firmware via Linux or Third Party Tools</i>	88
<i>GigE Server Verification</i>	89
<i>GigE Server Status</i>	89
OPTIMIZING THE NETWORK ADAPTER USED WITH NANO	90
QUICK TEST WITH CAMEXPERT (WINDOWS)	90
<i>About the Device User ID</i>	91
OPERATIONAL REFERENCE	92
USING CAMEXPERT WITH GENIE NANO CAMERAS	92
<i>CamExpert Panes</i>	92
CamExpert View Parameters Option	93
CAMERA INFORMATION CATEGORY	94
<i>Camera Information Feature Descriptions</i>	94
<i>Power-up Configuration Dialog</i>	98
Camera Power-up Configuration	98
Load / Save Configuration	98
SENSOR CONTROL CATEGORY	99
<i>Sensor Control Feature Descriptions</i>	100
<i>Offset/Gain Control Details (Sony sensors)</i>	103
Sony Sensors Gain Stage Diagram	103
<i>Offset/Gain Control Details (On-Semi Python sensors)</i>	104
On-Semi Python Sensors Gain Stage Diagram	104
<i>Bayer Mosaic Pattern</i>	105
<i>OnSemi Python P1 Sensor Artifacts with Fast Readout Mode</i>	105
Fast Readout Mode Artifacts Correction	106
<i>Exposure Alignment: Overview</i>	106
Synchronous Exposure Alignment	106
Reset Exposure Alignment	107
<i>Sensor Exposure Timing: Sony Sensor Models</i>	107
Trigger Characteristics: Start of Exposure	107
<i>Sensor Exposure Timing: OnSemi Python Models</i>	108
Trigger Characteristics: Start of Exposure	108
AUTO-BRIGHTNESS CONTROL CATEGORY	109
<i>Auto-Brightness Feature Descriptions</i>	109
<i>Using Auto-Brightness</i>	111
General Preparation	111
Auto-Brightness with Frame Luminance Averaging	112
Auto-Gain	112
Auto-Brightness by using Auto-Exposure and Auto-Gain	112
I/O CONTROL CATEGORY	113
<i>I/O Control Feature Descriptions</i>	114
I/O Module Block Diagram	118
Trigger Mode Details	118
Trigger Source Types (Trigger Mode=On)	118
Input Line Details	119
Trigger Overlap: Feature Details	120
Output Line Details	127
Output High and Output Low Block Diagram	127
COUNTER AND TIMER CONTROL CATEGORY	128
<i>Counter and Timer Control Feature Description</i>	128

Counter and Timer Group Block Diagram	132
Example: Counter Start Source = OFF	133
Example: Counter Start Source = CounterEnd (itself)	133
Example: CounterStartSource = EVENT and Signal (Edge Base)	134
Example: CounterStartSource = Line (Edge Base) Example	134
ADVANCED PROCESSING CONTROL CATEGORY	135
<i>Advanced Processing Control Feature Descriptions</i>	135
<i>Lookup Table (LUT) Overview</i>	138
LUT Size vs. Output Pixel Format	138
<i>Defective Pixel Replacement (Method 3)</i>	139
Example User Defective Pixel Map XML File	139
Defective Pixel Replacement Algorithm Description	140
COLOR PROCESSING CONTROL CATEGORY	141
<i>Color Processing Control Feature Description</i>	141
<i>Color Processing Functional Overview</i>	142
White Balance Operation	143
Simplified RGB Design Firmware Block Diagram	143
Saturation and Luminance Operation	144
FLAT FIELD CORRECTION CATEGORY	145
<i>Flat Field Correction Feature Description</i>	145
CYCLING PRESET MODE CONTROL CATEGORY	147
<i>Cycling Preset Mode Control Feature Description</i>	148
<i>Using Cycling Presets—a Simple Example</i>	152
Multi-Exposure Cycling Example Setup	152
<i>Cycling Reset Timing Details</i>	153
Case 1: Cycling with Internal Synchronous Increment	153
Case 2: Cycling with External Asynchronous Increment	153
<i>Using Cycling Presets with Output Controls</i>	154
Feature Settings for this Example	154
<i>Cycling Mode Constraints with a changing ROI</i>	155
Specifics Concerning OnSemi Sensor Models	155
Specifics Concerning Sony Sensor Models	155
IMAGE FORMAT CONTROL CATEGORY	156
<i>Image Format Control Feature Description</i>	157
<i>Width and Height Features for Partial Scan Control</i>	162
Vertical Cropping (Partial Scan)	162
Maximum Frame Rate Examples (Models M/C 1920 & 1940)	163
Maximum Frame Rate Examples (Models M2420 & M2450)	163
Maximum Frame Rate Examples (Models M2020 & M2050)	164
Maximum Frame Rate Examples (Models M/C 4040 & 4060)	164
Maximum Frame Rate Examples (Models M/C 4020 & 4030)	165
Maximum Frame Rate Examples (Model M/C 2590)	165
Maximum Frame Rate Examples (Model C 4900)	166
Maximum Frame Rate Examples (Model M/C 1930)	166
Maximum Frame Rate Examples (Model M/C 1240)	167
Maximum Frame Rate Examples (Model M/C 1280)	167
Maximum Frame Rate Examples (Models M/C 1450)	168
Maximum Frame Rate Examples (Model M/C 800)	168
Maximum Frame Rate Examples (Model M/C 640)	169
Maximum Frame Rate Examples (NanoXL M5100)	170
Maximum Frame Rate Examples (NanoXL M4090)	171
Horizontal Cropping (Partial Scan)	172
<i>Using the Multiple ROI Mode</i>	172
Important Usage Details	173
Example: Two Horizontal ROI Areas (2x1)	173
Example: Four ROI Areas (2x2)	174
Example: Actual Sample with Six ROI Areas (3x2)	174

<i>Horizontal and Vertical Flip</i>	176
Image Flip – Full Frame	176
Image Flip – Multi-ROI Mode	177
<i>Binning Function and Limitations</i>	178
Horizontal Binning Constraints	178
Vertical Binning Constraints	178
<i>Internal Test Pattern Generator</i>	179
METADATA CONTROL CATEGORY	180
<i>Metadata Control Category Feature Descriptions</i>	180
Important Metadata Notes:	183
<i>Extracting Metadata Stored in a Sapera Buffer</i>	184
ACQUISITION AND TRANSFER CONTROL CATEGORY	186
<i>Acquisition and Transfer Control Feature Descriptions</i>	187
Acquisition Buffering	188
Using Transfer Queue Current Block Count with CamExpert	189
“Acquisition Abort” Execution Exception with Model C4900	189
<i>Features that cannot be changed during a Transfer</i>	189
ACTION CONTROL CATEGORY	190
<i>Action Control Feature Descriptions</i>	191
GigE Vision Action Command Reference	191
Nano Features supporting Action Command	191
EVENT CONTROL CATEGORY	192
<i>Event Control Feature Descriptions</i>	193
Basic Exposure Events Overview	198
Events Associated with Triggered Synchronous Exposures	198
Events Associated with Triggered Multiple Frame Synchronous Exposures	199
<i>Overview of Precision Time Protocol Mode (IEEE 1588)</i>	200
PTP Master Clock Identity	200
An Example with two Nano Cameras	200
IEEE 1588 Reference Resources	201
<i>Examples using Timestamp Modulo Event for Acquisitions</i>	201
Case Examples Overview	201
Case 1: Simple Repeating Acquisitions as Upcoming Events	201
Case 2: Potential Uncertainty to the Start Time	202
Case 3: Timer Reset before the Actual Start Time	203
Case 4: Timer Reset after the Actual Start Time	204
Case 5: Changing ‘timestampModulo’ during Acquisitions	205
GIGE VISION TRANSPORT LAYER CONTROL CATEGORY	206
<i>GigE Vision Transport Layer Feature Descriptions</i>	206
Defaults for devicePacketResendBufferSize	211
GIGE VISION HOST CONTROL CATEGORY	212
<i>Teledyne DALSA TurboDrive</i>	212
FILE ACCESS CONTROL CATEGORY	212
<i>File Access Control Feature Descriptions</i>	213
Updating Firmware via File Access in CamExpert	216
Overview of the deviceUserBuffer Feature	216
Overview of Color Correction Coefficients	216
Open Source Software Licenses	217
IMPLEMENTING TRIGGER-TO-IMAGE RELIABILITY	218
OVERVIEW	218
<i>T2IR with Genie Nano</i>	218
NANO FEATURES FOR T2IR MONITORING	218

SAPERA TOOLS FOR NETWORKING	220
NANO IP CONFIGURATION MODE DETAILS	220
TECHNICAL SPECIFICATIONS	221
MECHANICAL SPECIFICATIONS — C & CS MOUNT:	221
MECHANICAL SPECIFICATIONS — NANOXL:	223
ADDITIONAL NOTES ON GENIE NANO IDENTIFICATION AND MECHANICAL	224
<i>Temperature Management</i>	224
SENSOR ALIGNMENT SPECIFICATION	224
CONNECTORS	225
<i>10-pin I/O Connector Details</i>	227
Camera DC Power Characteristics	227
I/O Mating Connector Specifications & Sources	228
<i>Power over Ethernet (PoE) Support</i>	229
<i>Input Signals Electrical Specifications</i>	230
External Input Details	230
External Input DC Characteristics	230
External Input AC Timing Characteristics	231
External Inputs: Using TTL/LVTTL Drivers	231
External Inputs: Using Common Collector NPN Drivers	232
External Inputs: Using Common Emitter NPN Driver	232
External Inputs: Using a Balanced Driver	233
<i>Output Signals Electrical Specifications</i>	233
External Output Details and DC Characteristics	233
External Output AC Timing Characteristics	234
External Outputs: Using External TTL/LVTTL Drivers	235
External Outputs: Using External LED Indicators	235
Using Nano Outputs to drive other Nano Inputs	237
COMPUTER REQUIREMENTS FOR NANO CAMERAS	238
<i>Host PC System</i>	238
<i>Recommended Network Adapters</i>	238
<i>Ethernet Switch Requirements</i>	239
IEEE 802.3x Pause Frame Flow Control	239
<i>Ethernet to Fiber-Optic Interface Requirements</i>	239
EC & FCC DECLARATIONS OF CONFORMITY	240
<i>Models: M/C1920, M/C1940</i>	240
<i>Models: M/C2590, M/C1930, M/C1280, M/C800, M/C640</i>	241
<i>Models: M/C2020, M/C2050, M/C2420, M/C2450</i>	242
<i>Models: M/C4020, M/C4030, M/C4040, M/C4060</i>	243
<i>Models: M/C5100, M/C4090</i>	244
ADDITIONAL REFERENCE INFORMATION	245
CHOOSING A LENS WITH THE CORRECT IMAGE CIRCLE	245
<i>Lens Options for Models 'M/C1940' & 'M/C1920'</i>	245
<i>Lens Options for Models '2450/2420' & '2050/2020'</i>	246
<i>Lens Options for Models '4060/4040/4030/4020'</i>	246
<i>Lens Options for Models 'M/C1450'</i>	247
<i>Lens Options for XL Models 'M/C 5100' and 'M/C 4090'</i>	247
<i>Lens Options for Model 'C4900'</i>	248
<i>Lens Options for Models 'M/C2590' & 'M/C 2540'</i>	248
<i>Lens Options for Models 'M/C1930'</i>	249
<i>Lens Options for Models 'M/C1280' & 'M/C1240'</i>	249
<i>Lens Options for Models 'M/C800'</i>	250
<i>Lens Options for Models 'M/C700'</i>	250

<i>Lens Options for Models 'M/C640'</i>	251
<i>Additional Lens Parameters (application specific)</i>	252
OPTICAL CONSIDERATIONS	252
<i>Illumination</i>	252
<i>Light Sources</i>	253
<i>IR Cut-off Filters</i>	253
Nano Models with Built-in IR Cut-off Filters	253
Guidelines for Choosing IR Cut-off Filters	254
Back Focal Variance when using any Filter	255
LENS MODELING	256
<i>Magnification and Resolution</i>	256
SENSOR HANDLING INSTRUCTIONS	257
<i>Electrostatic Discharge and the Sensor</i>	257
<i>Protecting Against Dust, Oil and Scratches</i>	257
<i>Cleaning the Sensor Window</i>	258
RUGGEDIZED CABLE ACCESSORIES	258
<i>Cable Manufactures Contact Information</i>	258
<i>Cable Assembly G3-AIOC-BLUNT1M</i>	259
<i>Cable Assembly G3-AIOC-BLUNT2M</i>	260
<i>Cable Assembly G3-AIOC-BRKOUT2M</i>	262
<i>Nano Generic Power Supply with no I/O</i>	264
<i>Components Express Right-Angle Cable Assemblies</i>	265
Cable Assembly: Right-Angle I/O Bunt End	265
Cable Assembly: Right-Angle I/O to Euro Block	266
Ruggedized RJ45 Ethernet Cables	267
Cable Assembly: Right-Angle Ethernet	268
Right-Angle Cable-Set (Mounted)	269
TROUBLESHOOTING	270
OVERVIEW	270
<i>Problem Type Summary</i>	270
<i>Verifying Network Parameters</i>	272
Before Contacting Technical Support	272
DEVICE AVAILABLE WITH OPERATIONAL ISSUES	272
<i>Firmware Updates</i>	272
<i>Power Failure during a Firmware Update—Now What?</i>	273
<i>Cabling and Communication Issues</i>	273
<i>Acquisition Error without Timeout Messages</i>	273
Grab has Random Bad Data or Noise	274
No camera exposure when expected	274
Camera acquisition is good but frame rate is lower than expected	275
Camera is functional, frame rate is as expected, but image is black	275
<i>Model C4900 Column Noise in Saturated Areas</i>	276
<i>Other Problems or Issues</i>	277
Preventing Dropped Packets by adjusting Power Options	277
Random Invalid Trigger Events	278
Minimum Sopera Version Required	278
Issues with uninstalling Cognex VisionPro with Sopera LT CamExpert	278
ADDENDUMS	279
AC CHARACTERISTICS OF 1 INPUT / 3 OUTPUT MODELS	279
DEFECTIVE PIXEL REPLACEMENT (METHOD 4)	280
<i>Example User Defective Pixel Map XML File</i>	280
<i>Monochrome Defective Pixel Replacement Algorithm Description</i>	280
<i>Color Defective Pixel Replacement Algorithm Description</i>	283

REVISION HISTORY	284
CONTACT INFORMATION	285
SALES INFORMATION	285
TECHNICAL SUPPORT	285
INDEX	286

Genie Nano Series Overview

Description

The Genie Nano series, a member of the Genie camera family, provides a new series of affordable easy to use digital cameras specifically engineered for industrial imaging applications requiring improved network integration.

Genie Nano cameras use the industries' latest leading sensors such as the Sony Pregius series and On-Semi Python series of global shutter active pixel-type CMOS image sensors.

Genie Nano cameras combine standard gigabit Ethernet technology (supporting GigE Vision 1.2) with the Teledyne DALSA Trigger-to-Image-Reliability framework to dependably capture and transfer images from the camera to the host PC. Genie Nano cameras are available in a number of models implementing different sensors, image resolutions, and feature sets, either in monochrome, monochrome NIR, or color versions.



GigE with TurboDrive

Genie Nano cameras include TurboDrive™ technology, delivering high speed data transfers exceeding the GigE limit. TurboDrive uses advanced data modeling to boost data transfers up to 2 or 3 times faster than standard GigE Vision speeds – with no loss of image quality. These breakthrough rates are achieved using a proprietary process that assembles data from the sensor to optimize throughput, simultaneously taking full advantage of both the sensor's maximum frame rate and the camera's maximum GigE data transfer speed (up to 115 Mbytes/s). [Teledyne DALSA's TurboDrive](#) increases system dependability and robustness similar to Camera Link throughput on a GigE network.

Important: Actual Transfers with TurboDrive is image content dependent but in the best case scenario, transfers over a GigE Network can reach the camera's internal acquisition limit of up to 252MB/sec. If transfers are less than the camera maximum acquisition rate, camera memory will be used as a circular frame buffer. **Note:** Not supported with RGB output firmware on any model due to camera resource limitations.

Refer to [TurboDrive Primer](#) on the Teledyne DALSA web site for more details.

Genie Nano Overview

- Optimized, rugged design with a wider operating temperature
- Available in multiple sensors/resolutions, monochrome and color
- Higher frame rates with Teledyne DALSA GigE Vision TurboDrive Technology
- Visual camera multicolor status LED on back plate
- Multi-ROI support
- 2 (default models) general purpose opto-coupled inputs
- 2 (default models) general purpose opto-coupled outputs (user, counter, or timer driven for Strobe and Flash triggering)
- Flexible general purpose Counter and Timer functions available for internal and external controls
- Software and hardware Events available to support imaging applications
- Cycling mode supports 64 multiple camera setups (including Multi-Exposure)
- Auto brightness (i.e. auto exposure and AGC) available on many models
- In-sensor and/or FPGA (digital) Binning available on monochrome models
- Supports Image Time-Stamp based on IEEE1588-2008 (PTP: Precise Time Protocol) or an Internal Timer
- Programmable Look-Up-Table (programmable LUT or preset Gamma) available
- Defective Pixel replacement available on some models
- Multicast and Action Command supported
- Image metadata supported
- Supports Power Over Ethernet (PoE) or auxiliary power input
- Implements 32 MB of Flash Memory
- 2 User Settings sets to store and recall camera configurations
- Supports the Gigabit Ethernet PAUSE Frame feature
- GigE Vision 1.2 compliant
- Gigabit Ethernet (GigE) interconnection to a computer via standard CAT5e or CAT6 cables
- Gigabit Ethernet (GigE) transfer speed up to 115 MB/second
- Application development with the freely available Sapera™ LT software libraries
- Native Teledyne DALSA Trigger-to-Image Reliability design framework
- Refer to the Operation Reference and Technical Specifications section of the manual for full details
- Refer to the Sapera LT 8.10 release notes for information on GigE Vision and TurboDrive Technology support.

Camera Firmware

Teledyne DALSA Genie Nano camera firmware contains open source software provided under different open source software licenses. More information about these open source licenses can be found in the documentation that accompanies the firmware, which is available on the Teledyne DALSA website at www.teledynedalsa.com or [downloaded directly from the Nano](#).

Important: Genie Nano firmware updates are available for download from the Teledyne DALSA web site www.teledynedalsa.com/imaging/support/downloads. Choose Genie Nano Firmware from the available download sections, then choose the zip file download specific to your camera model.

When using Sapera LT, update the camera firmware using CamExpert (see [File Access via the CamExpert Tool](#)). The Camera firmware can easily be upgraded within your own application via the API. The camera has a failsafe scheme which prevents unrecoverable camera errors even in the case of a power interruption.

Model Part Numbers

This manual covers the released Genie Nano monochrome and color models summarized in the two tables below. These tables list models in increasing resolution. Nano [common specifications](#) and details for each Genie Nano model follow these tables.

Monochrome Cameras

Model Full Resolution	Sensor Size/Model	Lens	Part Number
M640 672 x 512	On-Semi 0.3M (Python300 P1)	C-mount	G3-GM10-M0640
		CS-mount	G3-GM10-M0641
M640 NIR 672 x 512	On-Semi 0.3M (Python300 P1)	C-mount	G3-GM12-M0640
		CS-mount	G3-GM12-M0641
M700 728 x 544	Sony 0.4M (IMX287)	C-mount	G3-GM10-M0700
		CS-mount	G3-GM10-M0701
M700 NIR 728 x 544	Sony 0.4M (IMX287)	C-mount	G3-GM12-M0700
		CS-mount	G3-GM12-M0701
M800 832 x 632	On-Semi 0.5M (Python500 P1)	C-mount	G3-GM10-M0800
		CS-mount	G3-GM10-M0801
M800 NIR 832 x 632	On-Semi 0.5M (Python500 P1)	C-mount	G3-GM12-M0800
		CS-mount	G3-GM12-M0801
M1240 1280 x 1024	On-Semi 1.3M (Python1300 P3)	C-mount	G3-GM11-M1240
		CS-mount	G3-GM11-M1241
M1280 1280 x 1024	On-Semi 1.3M (Python1300 P1)	C-mount	G3-GM10-M1280
		CS-mount	G3-GM10-M1281
M1280 NIR 1280 x 1024	On-Semi 1.3M (Python1300 P1)	C-mount	G3-GM12-M1280
		CS-mount	G3-GM12-M1281
M1450 1456 x 1088	Sony 1.6M (IMX273)	C-mount	G3-GM10-M1450
		CS-mount	G3-GM10-M1451
M1930 1984 x 1264	On-Semi 2.3M (Python2000 P1)	C-mount	G3-GM10-M1930
		CS-mount	G3-GM10-M1931
M1930 NIR 1984 x 1264	On-Semi 2.3M (Python2000 P1)	C-mount	G3-GM12-M1930
		CS-mount	G3-GM12-M1931
M1940 1936 x 1216	Sony 2.3M (IMX174)	C-mount	G3-GM10-M1940
		CS-mount	G3-GM10-M1941
M1920 1936 x 1216	Sony 2.3M (IMX249)	C-mount	G3-GM11-M1920
		CS-mount	G3-GM11-M1921

Monochrome Cameras Continued

M2050 2048 x 1536	Sony 3.2M (IMX252)	C-mount	G3-GM10-M2050
		CS-mount	G3-GM10-M2051
M2020 2048 x 1536	Sony 3.2M (IMX265)	C-mount	G3-GM11-M2020
		CS-mount	G3-GM11-M2021
M2450 2448 x 2048	Sony 5.1M (IMX250)	C-mount	G3-GM10-M2450
		CS-mount	G3-GM10-M2451
M2420 2448 x 2048	Sony 5.1M (IMX264)	C-mount	G3-GM11-M2420
		CS-mount	G3-GM11-M2421
M2590 2592 x 2048	On-Semi 5.1M (Python5000 P1)	C-mount	G3-GM10-M2590
		CS-mount	G3-GM10-M2591
M2590 NIR 2592 x 2048	On-Semi 5.1M (Python5000 P1)	C-mount	G3-GM12-M2590
		CS-mount	G3-GM12-M2591
M4060 4112 x 2176	Sony 8.9M (IMX255)	C-mount	G3-GM10-M4060
		CS-mount	G3-GM10-M4061
M4030 4112 x 2176	Sony 8.9M (IMX267)	C-mount	G3-GM11-M4030
		CS-mount	G3-GM11-M4031
M4040 4112 x 3008	Sony 12M (IMX253)	C-mount	G3-GM10-M4040
		CS-mount	G3-GM10-M4041
M4020 4112 x 3008	Sony 12M (IMX304)	C-mount	G3-GM11-M4020
		CS-mount	G3-GM11-M4021

NanoXL Model Full Resolution	Sensor Size/Model	Lens	Part Number
M4090 4096 x 4096	On-Semi 16M (Python 16K)	M42 mount	G3-GM30-M4095
M4090-NIR 4096 x 4096	On-Semi 16M (Python 16K)	M42 mount	G3-GM32-M4095
M5100 5120 x 5120	On-Semi 25M (Python 25K)	M42 mount	G3-GM30-M5105
M5100-NIR 5120 x 5120	On-Semi 25M (Python 25K)	M42 mount	G3-GM32-M5105

Color Cameras

Model Full Resolution	Sensor Size/Model	Lens	Part Number	Notes
C640 672 x 512	On-Semi 0.3M (Python300 P1)	C-mount	G3-GC10-C0640	
			G3-GC10-C0640IF	with IR Cut-off Filter
		CS-mount	G3-GC10-C0641	
			G3-GC10-C0641IF	with IR Cut-off Filter
C700 728 x 544	Sony 0.4M (IMX287)	C-mount	G3-GC10-C0700	
			G3-GC10-C0700IF	with IR Cut-off Filter
		CS-mount	G3-GC10-C0701	
			G3-GC10-C0701IF	with IR Cut-off Filter
C800 832 x 632	On-Semi 0.5M (Python500 P1)	C-mount	G3-GC10-C0800	
			G3-GC10-C0800IF	with IR Cut-off Filter
		CS-mount	G3-GC10-C0801	
			G3-GC10-C0801IF	with IR Cut-off Filter
C1240 1280 x 1024	On-Semi 1.3M (Python1300 P3)	C-mount	G3-GC10-C1240	
			G3-GC10-C1240IF	with IR Cut-off Filter
		CS-mount	G3-GC10-C1241	
			G3-GC10-C1241IF	with IR Cut-off Filter
C1280 1280 x 1024	On-Semi 1.3M (Python1300 P1)	C-mount	G3-GC10-C1280	
			G3-GC10-C1280IF	with IR Cut-off Filter
		CS-mount	G3-GC10-C1281	
			G3-GC10-C1281IF	with IR Cut-off Filter
C1450 1456 x 1088	Sony 1.6M (IMX273)	C-mount	G3-GM10-C1450	
			G3-GM10-C1450IF	with IR Cut-off Filter
		CS-mount	G3-GM10-C1451	
			G3-GM10-C1451IF	with IR Cut-off Filter
C1930 1984 x 1264	On-Semi 2M (Python2000 P1)	C-mount	G3-GC10-C1930	
			G3-GC10-C1930IF	with IR Cut-off Filter
		CS-mount	G3-GC10-C1931	
			G3-GC10-C1931IF	with IR Cut-off Filter
C1940 1936 x 1216	Sony 2.3M (IMX174)	C-mount	G3-GC10-C1940	
			G3-GC10-C1940IF	with IR Cut-off Filter
		CS-mount	G3-GC10-C1941	
			G3-GC10-C1941IF	with IR Cut-off Filter
C1920 1936 x 1216	Sony 2.3M (IMX249)	C-mount	G3-GC11-C1920	
			G3-GC11-C1920IF	with IR Cut-off Filter
		CS-mount	G3-GC11-C1921	
			G3-GC11-C1921IF	with IR Cut-off Filter

Color Cameras Continued

C2050 2048 x 1536	Sony 3.2M (IMX252)	C-mount	G3-GC10-C2050	
			G3-GC10-C2050IF	with IR Cut-off Filter
		CS-mount	G3-GC10-C2051	
			G3-GC10-C2051IF	with IR Cut-off Filter
C2020 2048 x 1536	Sony 3.2M (IMX265)	C-mount	G3-GC11-C2020	
			G3-GC11-C2020IF	with IR Cut-off Filter
		CS-mount	G3-GC11-C2021	
			G3-GC11-C2021IF	with IR Cut-off Filter
C2450 2448 x 2048	Sony 5.1M (IMX250)	C-mount	G3-GC10-C2450	
			G3-GC10-C2450IF	with IR Cut-off Filter
		CS-mount	G3-GC10-C2451	
			G3-GC10-C2451IF	with IR Cut-off Filter
C2420 2448 x 2048	Sony 5.1M (IMX264)	C-mount	G3-GC11-C2420	
			G3-GC11-C2420IF	with IR Cut-off Filter
		CS-mount	G3-GC11-C2421	
			G3-GC11-C2421IF	with IR Cut-off Filter
C2590 2592 x 2048	On-Semi 5.1M (Python5000 P1)	C-mount	G3-GC10-C2590	
			G3-GC10-C2590IF	with IR Cut-off Filter
		CS-mount	G3-GC10-C2591	
			G3-GC10-C2591IF	with IR Cut-off Filter
C4060 4112 x 2176	Sony 8.9M (IMX255)	C-mount	G3-GC10-C4060	
			G3-GC10-C4060IF	with IR Cut-off Filter
		CS-mount	G3-GC10-C4061	
			G3-GC10-C4061IF	with IR Cut-off Filter
C4030 4112 x 2176	Sony 8.9M (IMX267)	C-mount	G3-GC11-C4030	
			G3-GC11-C4030IF	with IR Cut-off Filter
		CS-mount	G3-GC11-C4031	
			G3-GC11-C4031IF	with IR Cut-off Filter
C4040 4114 x 3008	Sony 12M (IMX253)	C-mount	G3-GC10-4040C	
			G3-GC10-C4040IF	with IR Cut-off Filter
		CS-mount	G3-GC10-C4041	
			G3-GC10-C4041IF	with IR Cut-off Filter

Color Cameras Continued

C4020 4114 x 3008	Sony 12M (IMX304)	C-mount	G3-GC11-4020C	
			G3-GC11-C4020IF	with IR Cut-off Filter
		CS-mount	G3-GC11-C4021	
			G3-GC11-C4021IF	with IR Cut-off Filter
C4900 4912 x 3682	On-Semi 18M (AR1820HS) Rolling Shutter	C-mount	G3-GC10-C4900	
			G3-GC10-C4900IF	with IR Cut-off Filter
		CS-mount	G3-GC10-C4901	
			G3-GC10-C4901IF	with IR Cut-off Filter

NanoXL Model Full Resolution	Sensor Size/Model	Lens	Part Number
C4090 4096 x 4096	On-Semi 16M (Python 16K)	M42 mount	G3-GC30-C4095
C5100 5120 x 5120	On-Semi 25M (Python 25K)	M42 mount	G3-GC30-C5105

Accessories

Nano Accessories & Cables (sold separately)		Order Number
<p>Mounting Bracket Plate</p> <p>(2 or 3 screw camera mount), with ¼ inch external device screw mount (also known as a tripod mount)</p>		<p>G3-AMNT-BRA01</p>
<p>I/O Blunt End Cable</p> <p>(1 meter Screw Retention to Flying Leads)</p> <p>(2 meter Screw Retention to Flying Leads)</p>		<p>G3-AIOC-BLUNT1M</p> <p>G3-AIOC-BLUNT2M</p>
<p>I/O Breakout Cable</p> <p>(2 meter Screw Retention to Euroblock connector)</p>		<p>G3-AIOC-BRKOUT2M</p>
<p>Power and Cable Evaluation Kit</p> <ul style="list-style-type: none"> • Includes a Power Supply (12V), • an Ethernet Cable (RJ-45, 2 meter), • and a 2 meter I/O Breakout Cable (Euroblock) 		<p>G3-ACBL-EVALKIT</p>
<p>Generic 12 volt power supply for Genie Nano–Aux connector (Samtec 10-Pin) – 4 Meter length</p>		<p>G3-APWS-S10S04M</p>
<p>NanoXL — M42 to F-mount (Nikon) adapter (same adapter part as used with Genie TS)</p> <p><i>Note that there is no support for Nikon lens features such as focus and aperture motor controls.</i></p>		<p>G2-AM42-MOUNT4</p>

Right angle I/O cables and Ethernet cables (including combo evaluation packages) are available directly from our preferred source (see [Components Express Right-Angle Cable Assemblies](#)).

Software Requirements



Sapera LT Development Software

Teledyne DALSA Software Platform for Microsoft Windows	
Sapera LT version 8.00 or later (8.10 or later recommended), for Windows. Includes Sapera Network Imaging Package and GigE Vision Imaging Driver, Sapera Runtime and CamExpert. Provides everything you will need to develop imaging applications Sapera documentation provided in compiled HTML help, and Adobe Acrobat® (PDF)	Available for download http://www.teledynedalsa.com/imaging/support/
Sapera Processing Imaging Development Library (available for Windows or Linux – sold separately):	Contact Teledyne DALSA Sales
Teledyne DALSA Software Platform for Linux	
GigE-V Framework Ver. 2.0 (for both X86 or Arm type processor)	Available for download http://teledynedalsa.com/imaging/products/software/linux-gige-v/

Third Party GigE Vision Development

Third Party GigE Vision Software Platform Requirements	
Support of GenICam GenApi version 2.3	General acquisition and control
Support of GenICam GenApi version 2.3	File access: firmware, configuration data, upload & download
Support of GenICam XML schema version 1.1	
GenICam™ support — XML camera description file	Embedded within Genie Nano

About GigE Vision

	<p>Genie Nano cameras are 100% compliant with the GigE Vision 1.2 specification which defines the communication interface protocol used by any GigE Vision device. The device description and capabilities are contained in an XML file. For more information see: https://www.visiononline.org/vision-standards-details.cfm?type=5</p>
	<p>Genie Nano cameras implement a superset of the GenICam™ specification which defines device capabilities. This description takes the form of an XML device description file respecting the syntax defined by the GenApi module of the GenICam™ specification. For more information see www.genicam.org.</p>

The Teledyne DALSA GigE Vision Module provides a license free development platform for Teledyne DALSA GigE hardware or Sapera vision applications. Additionally supported are Sapera GigE Vision applications for third party hardware with the purchase of a GigE Vision Module license, or the Sapera processing SDK with a valid license.

The GigE Vision Compliant XML device description file is embedded within Genie Nano firmware allowing GigE Vision Compliant applications access to Genie Nano capabilities and controls immediately after connection.

Genie Nano Specifications

The Nano common specifications listed first are followed by model specific tables of functional features and timing details.

Common Specifications

Camera Controls	
Synchronization Modes	Free running, External triggered, Software trigger through Ethernet, Precision Time Protocol (PTP)
Exposure Control	Internal – Programmable via the camera API External (Global Shutter models) – based on Trigger Width
Exposure Time Maximum	16 sec (Global Shutter models) 0.5 sec (Rolling Shutter model – C4900)
Exposure Modes	Programmable in increments of 1 μ s minimum (in μ s) is model specific Pulse controlled via Trigger pulse width (Global Shutter models).
Trigger Inputs	Opto-isolated, 2.4V to 24V typical, 16mA min. Debounce range from 0 up to 255 μ s Trigger Delay from 0 to 2,000,000 μ s
Strobe Outputs	Output opto-isolated: Aligned to the start of exposure with a programmable delay, duration and polarity (using “start of exposure on output line source” feature)
Features	
Image Buffer (VGA to 5M models) (8.9M to 18M models) (NanoXL models)	Refer to transferQueueMemorySize feature . 90 MB total on-board memory for acquisitions and packet resend buffering 200 MB total 500 MB total
Reserved Private User Buffer	4 kB flash memory for OEM usage (<i>deviceUserBuffer</i>)
Flash memory	32 MB flash memory implemented
Gain	In Sensor gain (model dependent) and Digital gain up to 4x
Auto-Brightness	Yes , with Auto-Exposure and AGC (Sensor Gain or FPGA Gain) <i>Note1: Sensor Gain AGC only with Sony sensors</i> <i>Note2: Not applicable to model C4900 (rolling shutter sensor)</i>
Color model output	Color cameras support Bayer output or RGB output firmware.
Binning (monochrome models)	Support for both Horizontal and Vertical Binning: 1x, 2x, and 4x in FPGA Models M640, M800, M1280, M1930, M2590, M4040, M4060 have in-sensor binning
LUT	Programmable LUT (Look-up-table) up to 12-Bit (model dependent)
Defective Pixel Replacement	Available on some models — up to 1024 entries (2048 for NanoXL)
Automatic White Balance	Available on Color models
Counter and Timer	1 Counter, and 1 Timer. User programmable, acquisition independent, with event generation, and can control Output I/O pins
Timestamp	Timer to Timestamp images and events (1 μ s tics using Internal Clock, 8 nanosecond tics when using IEEE1588 (PTP: Precise time Protocol)
Metadata	Metadata Output at the end of the Images (also known as GenICam Chunk Data)

Cycling Mode	Automatic cycling between 64 camera setups
Multicast	Programming support for multicasting images (requires Multicast host support: refer to the SDK documentation – if supported)
Action Command	Programmable for up to 2 GenICam Action Commands (requires host support: refer to the SDK documentation – if supported)
Test image	Internal generator with choice of static and shifting patterns
User settings	Select factory default or either of two user saved camera configurations
TurboDrive Technology	Supported with 8-bit or 16-bit buffer format (see Sapera 8.10 release notes) Not supported with RGB output firmware for any Nano model due to limitations of camera resources.
Back Focal Distance	
	17.52 mm (C-mount models), 12.52 mm (CS-mount models) 12 mm (model NanoXL)
Mechanical Interface	
Camera (L x H x W) see Mechanical Specifications	21.2 mm x 29 mm x 44 mm (without lens mount or Ethernet connector) 38.9 mm x 29 mm x 44 mm (with C-mount and Ethernet connector) 23.7 mm x 59 mm x 59 mm (NanoXL without Ethernet connector) 38.3 mm x 59 mm x 59 mm (NanoXL with Ethernet connector)
Mass (<i>approximate value due to sensor variations</i>)	~ 46g (C-mount with no lens) ~ 163g — model NanoXL
Power connector	via the 10-pin I/O connector, or RJ45 in PoE mode
Ethernet connector	RJ45
Electrical Interface	
Input Voltage	+12 to +36 Volts DC (+10%/- 10%) +10 to +56 Volts DC (Absolute min/max Range) on Auxiliary connector Supports the Power Over Ethernet standard. (PoE Class 3 as per IEEE 802.3af)
Inputs/Outputs	Default models have 2 Inputs and 2 Outputs Optional models have 1 Input and 3 Outputs XL models have 2 Inputs and 3 Outputs
Power Dissipation (typical)	Nano: PoE Class 2 From 3.8W to 4.9W dependent on Nano model and power supply voltage NanoXL: PoE Class 3 (Up to 7W) or external 24Volt power (6.6W)
Data Output	Gigabit Ethernet 1000Mbps (10/100 Mbps are not supported) 115 MB/sec max.
Ethernet Option supported	PAUSE Frame support (as per IEEE 802.3x)
Data and Control	GigE Vision 1.2 compliant
Environmental Conditions	
Operating Temperature (<i>at camera front plate</i>)	All Models: -20°C to +65°C (-4°F to +149°F) Model C4900 Exception: -20°C to +50°C (-4°F to +122°F) Temperature range specification based on an auxiliary input voltage of +20 to +36Vdc or PoE. <i>Any metallic camera mounting provides heat-sinking therefor reducing the internal temperature.</i>
Operating Relative Humidity	10% to 80% non-condensing
Storage	-40°C to +80°C (-4°F to +176°F) temperature at 20% to 80% non-condensing relative humidity
Conformity	CE , FCC , GenICam , GigE Vision , IP30, IEEE 802.3af (PoE)

Sensor Cosmetic Specifications

After Factory Calibration and/or Corrections are Applied (if applicable — dependent on sensor)

Blemish Specifications	Maximum Number of Defects	Blemish Description
Hot/Dead Pixel defects	Typical 0.0025% Max 0.005%	Any pixel that deviates by $\pm 20\%$ from the average of neighboring pixels at 50% saturation including pixel stuck at 0 and maximum saturated value.
Spot defects	none	Grouping of more than 8 pixel defects within a sub-area of 3x3 pixels, to a maximum spot size of 7x7 pixels.
Clusters defects	none	Grouping of more than 5 single pixel defects in a 3x3 kernel.
Column defects	none	Vertical grouping of more than 10 contiguous pixel defects along a single column.
Row defects	none	Horizontal grouping of more than 10 contiguous pixel defects along a single row.

- **Test conditions**
 - Nominal light = illumination at 50% of saturation
 - Temperature of camera is 45°C
 - At exposures lower than 0.1 seconds
 - At nominal sensor gain (1x)
- **For Model C4900** (Rolling Shutter sensor) see [Model C4900 Sensor Cosmetic Specifications](#)
- **On-Semi Python Sensor Limitations:**
 - Guaranteed pixel saturation: from a minimum exposure to 100 millisecond (Gain1.0) for the 0.3M to 5M models
 - Guaranteed pixel saturation: from a minimum exposure to 10 millisecond (Gain1.0) for the 16M to 25M models
- **Sony Sensor Limitation:**
 - Max pixel saturated values: Max Pixel format bit depth – 1DN (either 10-bit or 12-bit, as designed by Sony)

Dynamic Range & Signal to Noise Ratio Measurement Conditions

Specifications calculated according to EMVA-1288 standard, using white LED light

Dynamic Range Test Conditions

- Exposure 100 μ s
- 0% Full Light Level

SNR Test Conditions

- Exposure 2000 μ s
- 80% saturation

EMI, Shock and Vibration Certifications

Compliance Directives	Standards ID	Overview
CE	EN61000-4-2 : 2008	Electrostatic discharge immunity test
	EN61000-4-3 : 2006 A1 : 2007 A2 : 2010	Radiated, radio-frequency, electromagnetic field immunity test
	EN61000-4-4 : 2004	Electrical fast transient/burst immunity test
	EN61000-4-5 : 2005	Surge immunity
	EN61000-4-6 : 2008	Immunity to conducted disturbances, induced by radio-frequency fields
	EN61000-4-8 : 2009	Power frequency magnetic field immunity
	EN61000-4-11 : 2004	Voltage variations immunity
	EN61000-6-2 : 2005	Electromagnetic immunity
	EN61000-6-4: 2007	Electromagnetic emissions
	CISPR 11: 2009 A1 : group 1 FCC, part 15, subpart B:2010	Limit: class A Conducted Emissions
	CISPR 22 : 2008 Limit: class A	LAN port Conducted Emissions
FCC	Part 15, class A	
RoHS	Compliance as per European directive 2011/65/EC	
For an image of Genie Nano certificates see "EC & FCC Declarations of Conformity" on page 240		
Vibration & Shock Tests	Test Levels (while operating)	Test Parameters
Random vibrations	Level 1: 2 grms 60 min. Level 2: 4 grms 45 min. Level 3: 6 grms 30 min.	Frequency range: 5 to 2000 Hz Directions: X, Y, and Z axes
Shocks	Level 1: 20 g / 11 ms Level 2: 30 g / 11 ms Level 3: 40 g / 60 ms	Shape: half-sine Number: 3 shocks (+) and 3 shocks (-) Directions: ±X, ±Y, and ±Z axes
Additional information concerning test conditions and methodologies is available on request.		

Mean Time between Failure (MTBF)

The analysis was carried out for operating temperatures varying from 0 to 80°C. The following table presents the predicted MTBF and failure rate values.

Camera Assembly			
Temperatures	MTBF (hours)	MTBF (years)	Failure Rate (Failure/10 ⁶ hours)
0	3514728	401.2	0.284517
20	2040096	232.9	0.490173
40	1005703	114.8	0.994329
60	434538	49.6	2.301294
80	177030	20.2	5.648757

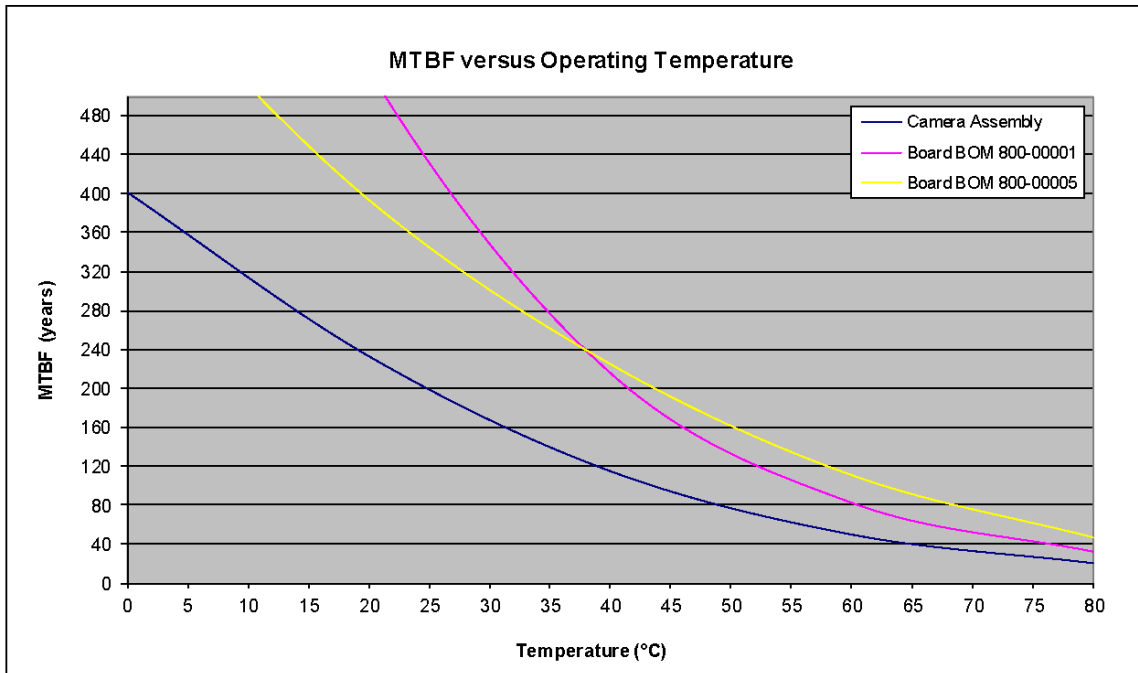

Sony Sensor Models

Genie Nano cameras utilizing Sony sensors (monochrome and color) are described.

Specifications: M700, C700

Supported Features	Nano-M700	Nano-C700	
Resolution	728 × 544		
Sensor	Sony IMX287 (0.4M)		
Pixel Size	6.9 μm x 6.9 μm		
Shutter type	Full frame electronic global shutter function		
Full Well charge	22ke (max)		
Firmware option (Field programmable)	Standard Design Monochrome	Standard Design Bayer	RGB-Output Design
Max. Internal Frame Rate Full resolution	310.7 fps		
Maximum Sustained Frame Rate Output (with TurboDrive v1)	310.7 fps (8-bits and 12-bits)		N/A
Maximum Sustained Frame Rate Output (without TurboDrive)	305 fps (8-bits) 155 fps (12-bits)	xxx fps (RGBA) xxx fps (RGB) xxx fps (Yuv422) xxx fps (8-bit mono)	
Pixel Data Formats	Mono 8-bit Mono 12-bit	Bayer 8-Bit Bayer 12-Bit	RGBA 32-bit RGB 24-bit Yuv422 16-bit Mono 8-bit
Trigger to Exposure Minimum delay (Synchronous Exposure Alignment)	2 line time (11.0 μs)		
Trigger to Exposure Minimum delay (Reset Exposure Alignment)	0 μs		
Trigger to Exposure Start jitter (best case with Synchronous Exposure Alignment)	Up to 1 line time 0 to 5.5 μs		
Trigger to Exposure Start jitter (Reset Exposure Alignment)	0 μs		
Actual Exposure Time Minimum (see "exposureTimeActual" feature)	19.76 μs (1 line time + 14.26 us) (increment of steps of 5.5 μs)		
Min. Time from End of Exposure to Start of Next Exposure (second frame)	18 line times – 14.26 μs (84.74 μs)		
Horizontal Line Time:	5.5 μs		
Readout Time	(Horizontal Line Time) x (lines in frame + 22) — in μs		
Auto-Brightness	Yes, with Auto-Exposure and AGC (FPGA Gain or Sensor Gain)		
Black offset control	Yes (in DN)		

Gain Control	In-sensor Gain (1.0x to 251x) In-FPGA Digital Gain (1x to 4x) in 0.007x step	
Binning Support	Yes, In-FPGA Only (Summing and Averaging 2x2, 4x4)	No
Decimation Support	No	
Defective Pixel Replacement	No	
Image Correction	No	
Image Flip Support	Yes, In-Sensor, Vertical and Horizontal	
Multi-ROI Support	Yes in FPGA, up to 16 ROI (mutually exclusive with binning)	
On-Board Image Memory	90MB	
Output Dynamic Range (dB)	xxx dB (in 12-Bit Pixel Format)	
SNR (dB)	xxx dB (in 12-Bit Pixel Format)	

Spectral Response

Monochrome Model M700, (Sony IMX287)

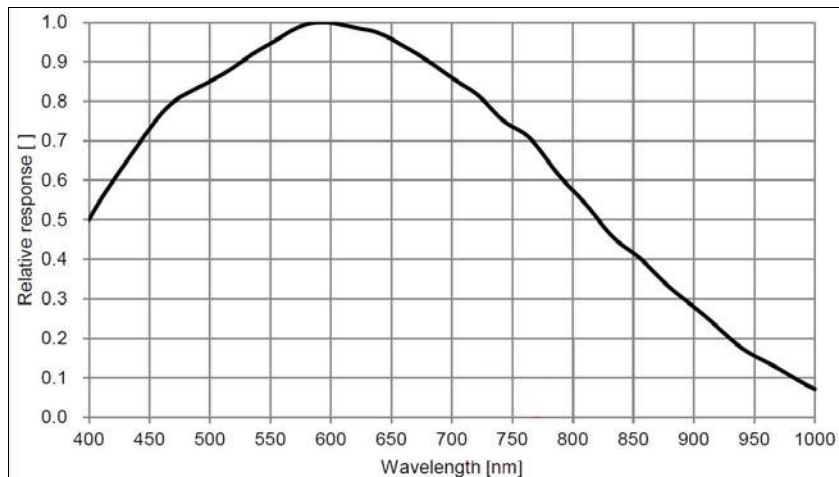

Color Model C700, (Sony IMX287)

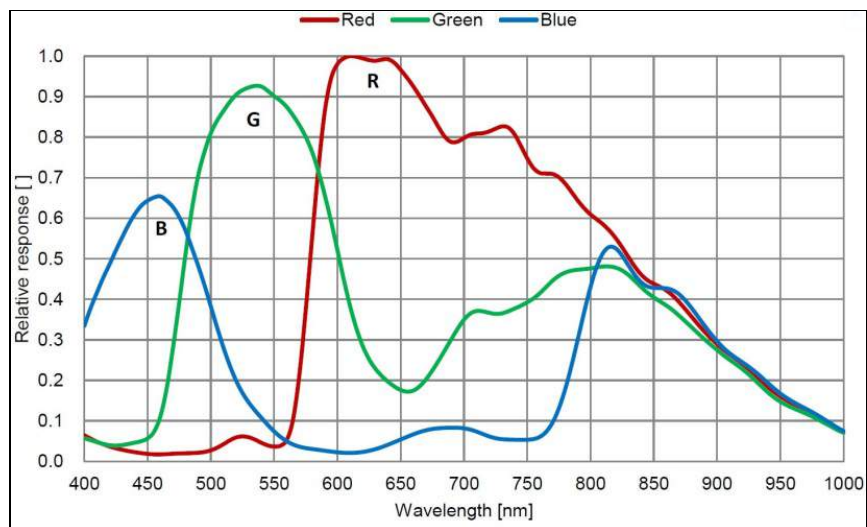

Firmware Files for Models M700, C700

The latest firmware files for all Nano models are available on the Teledyne DALSA support web site: [http://www.teledynedalsa.com/imaging/support/downloads/firmware/.](http://www.teledynedalsa.com/imaging/support/downloads/firmware/) The firmware files for these models are listed below. The xx denotes the current build number.

M700

- Standard
"Genie_Nano_Sony_IMX287_0.4M_Mono_STD_Firmware_16CA18.xx.cbf"

C700

- Bayer Output
"Genie_Nano_Sony_IMX287_0.4M_Bayer_STD_Firmware_17CA18.1.cbf"
- RGB Output
"Genie_Nano_Sony_IMX287_0.4M_RGB_Output_Firmware_17CA18.x.cbf"

Specifications: M1450, C1450

Supported Features	M1450	C1450	
Resolution	1456 x 1088		
Sensor	Sony IMX273 (1.6M)		
Pixel Size	3.45 μm x 3.45 μm		
Shutter type	Full frame electronic global shutter function		
Full Well charge	11ke (max)		
Firmware option (Field programmable)	Standard Design Monochrome	Standard Design Bayer	RGB-Output Design
Max. Internal Frame Rate Full resolution	161 fps at 1456 x 1088 resolution		
Maximum Sustained Frame Rate Output (with TurboDrive v1) *	161 fps at 1456 x 1088 resolution (8-bits) 80 fps at 1456 x 1088 resolution (12-bits)	N/A	
Maximum Sustained Frame Rate Output (without TurboDrive)	75 fps at 1456 x 1088 resolution (8-bits) 36 fps at 1456 x 1088 resolution (12-bits)	19.4 fps (RGBA) 25.9 fps (RGB) 38.9 fps (Yuv422) 77.9 fps (8-bit mono)	
Pixel Data Formats	Monochrome 8-bit Monochrome 12-bit	Bayer 8-bit Bayer 12-bit	RGBA 32-bit RGB 24-bit Yuv422 16-bit Mono 8-bit
Trigger to Exposure Minimum delay (Synchronous Exposure Alignment)	2 line time (11 μs)		
Trigger to Exposure Minimum delay (Reset Exposure Alignment)	0 μs		
Trigger to Exposure Start jitter (best case with Synchronous Exposure Alignment)	Max 1 line time (0 to 5.5 μs)		
Trigger to Exposure Start jitter (Reset Exposure Alignment)	0 μs		
Actual Exposure Time Minimum (see "exposureTimeActual" in Sensor Control)	19.7 μsec in 5.5 μsec steps (i.e. 1 line time + 14.26 μs)		
Min. Time from End of Exposure to Start of Next Exposure (second frame)	18 line times – 14.26 μs (84.74 μs)		
Horizontal Line Time:	5.5 μs		
Readout Time	(H line time) x (lines in frame + 22) in μs		
Auto-Brightness	Yes , with Auto-Exposure and AGC (FPGA Gain or Sensor Gain)		
Black offset control	Yes		
Gain Control	In-sensor Analog Gain (1x to 16x) In-sensor Digital Gain (1 to 16x)		
Binning Support	Yes In-FPGA (summing and average) 2x2, 4x4	NO	
Color Correction Support	NO		
Decimation Support	NO		
Defective Pixel Replacement	NO		
Image Correction	NO		
Image Flip Support	Yes, In-Sensor, Vertical and Horizontal		

Multi-ROI Support	Yes, in sensor up to 4 ROI (2x2) (mutually exclusive with binning)
On-Board Image Memory	90 MB
Output Dynamic Range (dB)	73.60
SNR (dB)	39.40

*TurboDrive internal limitation of 250MB/sec

Spectral Response

Monochrome Model M1450, (Sony IMX273)

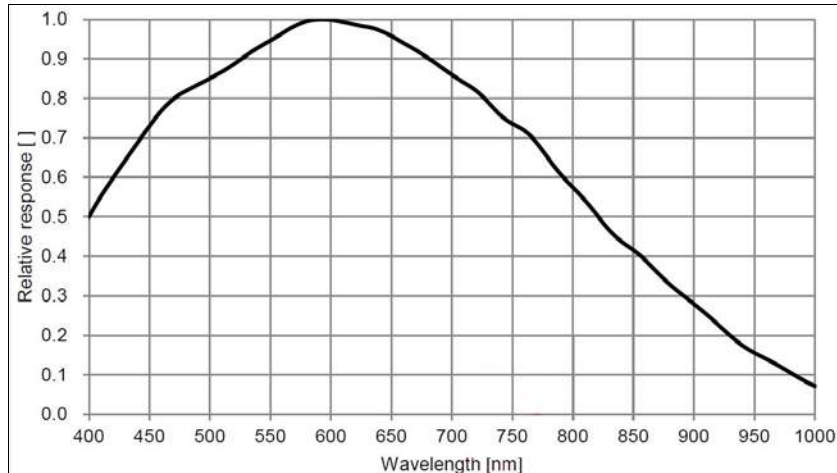

Color Model C1450, (Sony IMX273)

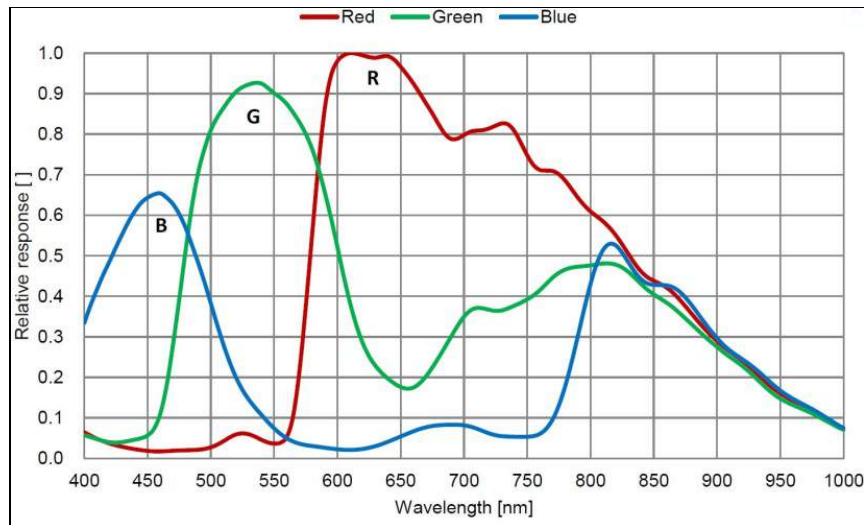

Firmware Files for Models 1450

M1450

- Standard
Genie_Nano_Sony_IMX273_1.6M_Mono_STD_Firmware_10CA18.x.cbf

C1450

- Standard
Genie_Nano_Sony_IMX273_1.6M_Bayer_STD_Firmware_11CA18.x.cbf

Specifications: M1920, C1920

Supported Features	M1920	C1920	
Resolution	1936 x 1216		
Sensor	Sony IMX249 (2.3M)		
Pixel Size	5.86 μm x 5.86 μm		
Shutter type	Full frame electronic global shutter function		
Full Well charge	32ke (max)		
Firmware option (Field programmable)	Standard Design Monochrome	Standard Design Bayer	RGB-Output Design
Max. Internal Frame Rate Full resolution	38.8 fps		
Maximum Sustained Frame Rate Output (with TurboDrive v1)	38.8 fps (8-bit) 38.8 fps (12-bit)	N/A	
Maximum Sustained Frame Rate Output (without TurboDrive)	38.8 fps (8-bit) 25 fps (12-bit)	13 fps (RGBA) 19.5 fps (RGB) 26 fps (Yuv422) 38.8fps (8-bit mono)	
Pixel Data Formats	Mono 8-bit Mono 12-bit	Bayer 8-Bit Bayer 12-Bit	RGBA 32-bit RGB 24-bit Yuv422 16-bit Mono 8-bit
Trigger to Exposure Minimum delay (Synchronous Exposure Alignment)	2 line time (41.5 μs)		
Trigger to Exposure Minimum delay (Reset Exposure Alignment)	Not supported by this sensor		
Trigger to Exposure Start jitter (best case with Synchronous Exposure Alignment)	Up to 1 line time 0 to 20.5 μs		
Trigger to Exposure Start jitter (Reset Exposure Alignment)	Not supported by this sensor		
Actual Exposure Time Minimum (see "exposureTimeActual" in Sensor Control)	34.23 μs (1 line time + 13.73 μs) (increment steps of 20.5 μs)		
Min. Time from End of Exposure to Start of Next Exposure	13 lines (266.5 μs)		
Horizontal Line Time:	20.5 μs		
Readout Time	(Horizontal Line Time) x (lines in frame +20) — in μs		
Auto-Brightness	Yes , with Auto-Exposure and AGC (FPGA Gain or Sensor Gain)		
Black offset control	Yes (in DN)		
Gain Control	In-sensor Gain (1.0x to 251x) In-FPGA Digital Gain (1x to 4x) in 0.007x steps		
Binning Support	Yes In-FPGA (summing and average) 2x2, 4x4	No	
Color Correction Support	No		Yes
Decimation Support	No		
Defective Pixel Replacement	No		

Image Correction	No
Image Flip Support	Yes, In-Sensor, Vertical and Horizontal
Multi-ROI Support	Yes, in FPGA, up to 16 ROI (mutually exclusive with binning)
On-Board Image Memory	90MB
Output Dynamic Range (dB)	72.1 dB (in 12-Bit Pixel Format)
SNR (dB)	44.3 dB (in 12-Bit Pixel Format)

Specifications: M1940, C1940

Supported Features	Nano-M1940	Nano-C1940	
Resolution	1936 x 1216		
Sensor	Sony IMX174 (2.3M)		
Pixel Size	5.86 μm x 5.86 μm		
Shutter type	Full frame electronic global shutter function		
Full Well charge	32ke (max)		
Firmware option (Field programmable)	Standard Design Monochrome	Standard Design Bayer	RGB-Output Design
Max. Internal Frame Rate Full resolution	83.9 fps		
Maximum Sustained Frame Rate Output (with TurboDrive v1)	83.9 fps (8-bit) 53 fps (10-bit)		N/A
Maximum Sustained Frame Rate Output (without TurboDrive)	52 fps (8-bit) 26 fps (10-bit)		13 fps (RGBA) 19.5 fps (RGB) 26 fps (Yuv422) 38.8fps (8-bit mono)
Pixel Data Formats	Mono 8-bit Mono 10-bit	Bayer 8-Bit Bayer 10-Bit	RGBA 32-bit RGB 24-bit Yuv422 16-bit Mono 8-bit
Trigger to Exposure Minimum delay (Synchronous Exposure Alignment)	2 line time (19 μs)		
Trigger to Exposure Minimum delay (Reset Exposure Alignment)	Not supported by this sensor		
Trigger to Exposure Start jitter (best case with Synchronous Exposure Alignment)	Up to 1 line time 0 to 9.5 μs		
Trigger to Exposure Start jitter (Reset Exposure Alignment)	Not supported by this sensor		
Actual Exposure Time Minimum (see "exposureTimeActual" in Sensor Control)	23.23 μs (1 line time + 13.73 μs) (increment steps of 9.5 μs)		
Min. Time from End of Exposure to Start of Next Exposure (second frame)	13 lines (123.5 μs)		
Horizontal Line Time:	9.5 μs		
Readout Time	(Horizontal Line Time) x (lines in frame +20) — in μs		
Auto-Brightness	Yes, with Auto-Exposure and AGC (FPGA Gain or Sensor Gain)		
Black offset control	Yes (in DN)		

Gain Control	In-sensor Gain (1.0x to 251x) In-FPGA Digital Gain (1x to 4x) in 0.007x steps	
Binning Support	Yes In-FPGA (summing and average) 2x2, 4x4	No
Color Correction Support	No	Yes
Decimation Support	No	
Defective Pixel Replacement	No	
Image Correction	No	
Image Flip Support	Yes, In-Sensor, Vertical and Horizontal	
Multi-ROI Support	Yes, in-sensor, up to 16 ROI (mutually exclusive with binning)	
On-Board Image Memory	90MB	
Output Dynamic Range (dB)	68.3 dB (in 10-Bit Pixel Format)	
SNR (dB)	43.9 dB (in 10-Bit Pixel Format)	

Notes:

*** Entire Resolution includes Over-scan pixels:**

- Active resolution is 1920 x 1200. The 8 + 8 additional pixels per line and 8 + 8 additional vertical lines are available for preprocessing and/or camera mechanical alignment operations in a system.

**** Limited to the Genie Nano Architecture:**

- ~250MB/sec Sustained into the TurboDrive Engine
- Additional note: This transfer was achieved using 1500 Byte Packet Size.

***** Actual Exposure Time:**

- The actual internal minimum exposure may be different than what is programmed. Use the feature "exposureTimeActual" from the [Sensor Control](#) category to read back the actual sensor exposure.

Firmware Files for 1920, 1940

The latest firmware files for all Nano models are available on the Teledyne DALSA support web site:
<http://www.teledynedalsa.com/imaging/support/downloads/firmware/>

The firmware files for these models are listed below. The xx denotes the current build number.

M1920

- Standard
"Genie_Nano_Sony_IMX249-2M_Mono_STD_Firmware_3CA18.xx.cbf"

C1920

- Bayer Output
"Genie_Nano_Sony_IMX249-2M_Bayer_STD_Firmware_4CA18.xx.cbf"
- RGB Output
"Genie_Nano_Sony_IMX249-2M_RGB_Output_Firmware_4CA18.xx.cbf"

M1940

- Standard
"Genie_Nano_Sony_IMX174-2M_Mono_STD_Firmware_1CA18.xx.cbf"

C1940

- Bayer Output
"Genie_Nano_Sony_IMX174-2M_Bayer_STD_Firmware_2CA18.xx.cbf"
- RGB Output
"Genie_Nano_Sony_IMX174-2M_RGB_Output_Firmware_4CA18.xx.cbf"

Spectral Response

Monochrome Models M194x & M192x, (Sony IMX174 & IMX249)

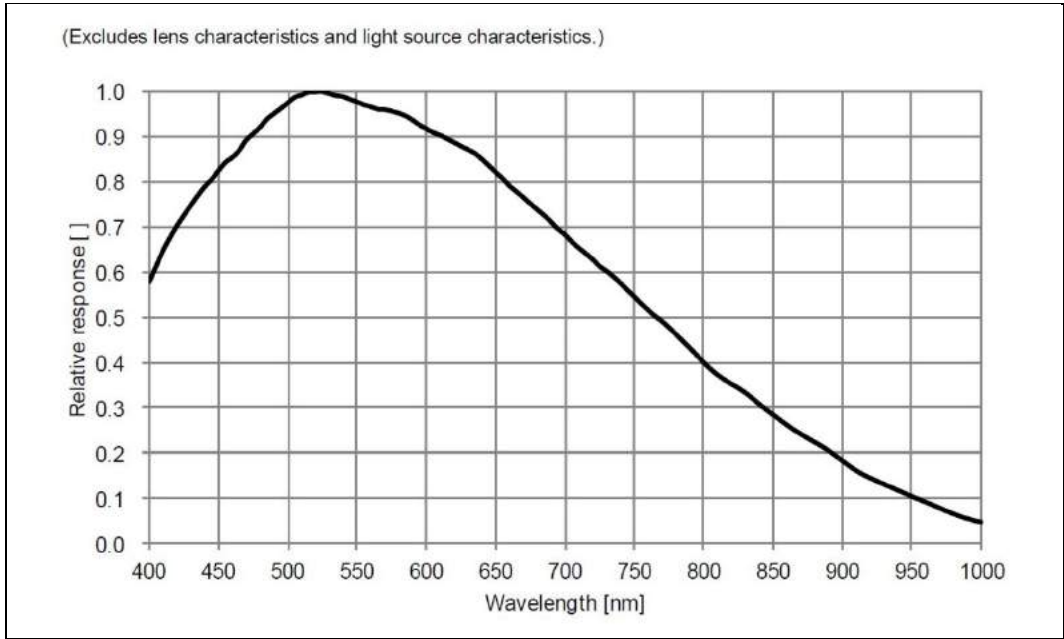

Measured Fill-Factor x Quantum Efficiency (FF x QE)

Color Models C194x & C192x, (Sony IMX174 & IMX249)

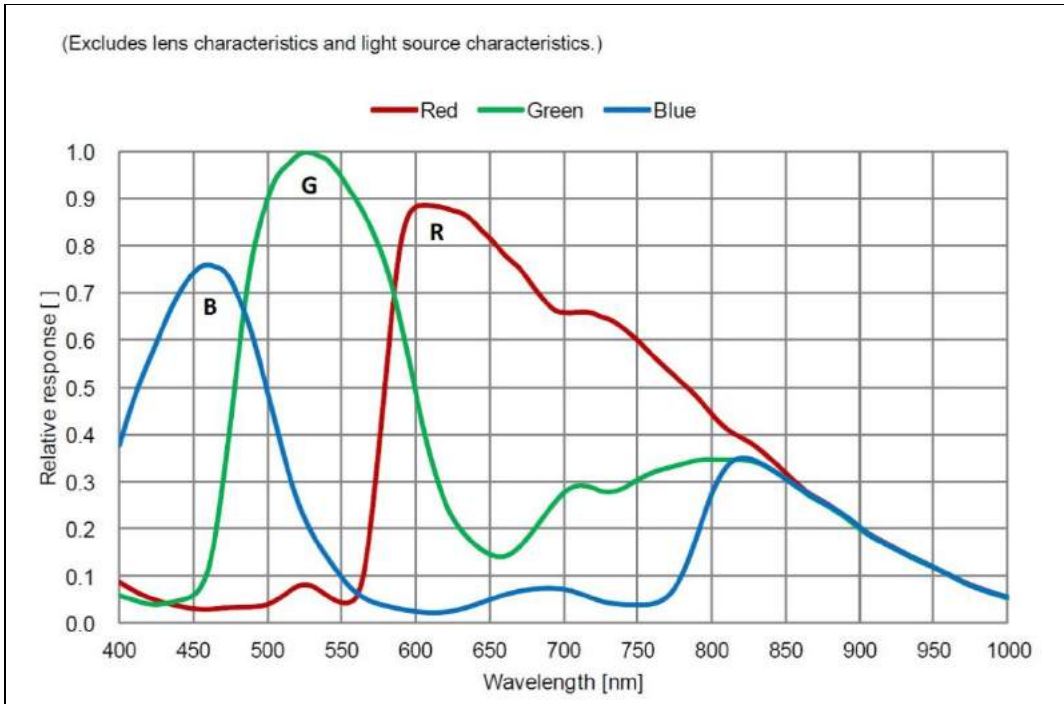

Measured Fill-Factor x Quantum Efficiency (FF x QE)

Specifications: M2020, C2020

Supported Features	Nano-M2020	Nano-C2020	
Resolution	2064 x 1544		
Sensor	Sony IMX265 (3.2M)		
Pixel Size	3.45 μm x 3.45 μm		
Shutter type	Full frame electronic global shutter function		
Full Well charge	11ke (max)		
Firmware option (Field programmable)	Standard Design Monochrome	Standard Design Bayer	RGB-Output Design
Max. Internal Frame Rate Full resolution	53.3 fps		
Maximum Sustained Frame Rate Output (with TurboDrive v1) *	53.3 fps (8-bit) 41.0 fps (12-bit)		N/A
Maximum Sustained Frame Rate Output (without TurboDrive)	38 fps (8-bit) 18 fps (12-bit)		9 fps (RGBA) 13.5 fps (RGB) 18 fps (Yuv422) 38 fps (mono8)
Pixel Data Formats	Mono 8-bit Mono 12-bit	Bayer 8-Bit Bayer 12-Bit	RGBA 32-bit RGB 24-bit Yuv422 16-bit Mono 8-bit
Trigger to Exposure Minimum delay (Synchronous Exposure Alignment)	2 line time (23.8 μs)		
Trigger to Exposure Minimum delay (Reset Exposure Alignment)	0 μs		
Trigger to Exposure Start jitter (best case with Synchronous Exposure Alignment)	Up to 1 line time 0 to 11.9 μs		
Trigger to Exposure Start jitter (Reset Exposure Alignment)	0 μs		
Actual Exposure Time Minimum (see "exposureTimeActual" in Sensor Control)	25.65 μs (1 line time + 13.73 us) (increment steps of 11.9 μs)		
Min. Time from End of Exposure to Start of Next Exposure (second frame)	8 lines (81.6 μs)		
Horizontal Line Time:	11.9 μs		
Readout Time	(Horizontal Line Time) x (lines in frame +17) — in μs		
Auto-Brightness	Yes , with Auto-Exposure and AGC (FPGA Gain or Sensor Gain)		
Black offset control	Yes (in DN)		
Gain Control	In-sensor Gain (1.0x to 251x) In-FPGA Digital Gain (1x to 4x) in 0.007x step		
Binning Support	Yes In-FPGA (summing and average) 2x2, 4x4	No	
Color Correction Support	No		Yes
Decimation Support	No		
Defective Pixel Replacement	No		
Image Correction	No		
Image Flip Support	Yes, In-Sensor, Vertical and Horizontal		

Multi-ROI Support	Yes, in FPGA, up to 16 ROI (mutually exclusive with binning)
On-Board Image Memory	90MB
Output Dynamic Range (dB)	76.4 dB (in 12-Bit Pixel Format)
SNR (dB)	39.6 dB (in 12-Bit Pixel Format)

* **Limited to the Genie Nano Architecture:**

~250MB/sec Sustained into the TurboDrive Engine achieved using 1500 Byte Packet Size

Firmware Files for Models 2020

The latest firmware files for all Nano models are available on the Teledyne DALSA support web site:

<http://www.teledynedalsa.com/imaging/support/downloads/firmware/>

The firmware files for these models are listed below. The xx denotes the current build number.

M2020

- Standard
"Genie_Nano_Sony_IMX264-265_3.2M-5.1M_Mono_STD_Firmware_9CA18.xx.cbf"

C2020

- Bayer Output
"Genie_Nano_Sony_IMX264-265_3.2M-5.1M_Bayer_STD_Firmware_ACA18.xx.cbf"
- RGB Output
"Genie_Nano_Sony_IMX264-265_3.2M-5.1M_RGB_Firmware_ACA18.xx.cbf"

Specifications: M2050

Supported Features	Nano-M2050	
Resolution	2064 x 1544	
Sensor	Sony IMX252 (3.2M)	
Pixel Size	3.45 μm x 3.45 μm	
Shutter type	Full frame electronic global shutter function	
Firmware option (Field programmable)	High Sensitivity Design	Standard Design
Full Well charge; dependent on Firmware Design Loaded	2750e- (max)	11ke (max)
Sensitivity to Saturation	4x	1x
Max. Internal Frame Rate Full resolution	143 fps	116 fps
Maximum Sustained Frame Rate Output (with TurboDrive v1) *	82 fps (8-bit)	
Maximum Sustained Frame Rate Output (without TurboDrive)	38 fps (8-bit)	
Pixel Data Formats	Mono 8-bit	
Trigger to Exposure Minimum delay (Synchronous Exposure Alignment)	2 line time (8.8 μs)	2 line time (10.8 μs)
Trigger to Exposure Minimum delay (Reset Exposure Alignment)	0 μs	

Trigger to Exposure Start jitter (best case with <i>Synchronous Exposure Alignment</i>)	Max 1 line (0 to 4.4µs)	Max 1 line (0 to 5.4µs)
Trigger to Exposure Start jitter (<i>Reset Exposure Alignment</i>)	0 µs	
Actual Exposure Time Minimum (see "exposureTimeActual" in Sensor Control)	18.1µs (1 line time + 13.73 us) (increment of 4.4µs steps)	19.1µs (1 line time + 13.73 us) (increment of 5.4µs steps)
Min. Time from End of Exposure to Start of Next Exposure	10 lines–13.73µs (30.3 µs)	10 lines–13.73µs (40.4 µs)
Horizontal Line Time:	4.4µs	5.4µs
Readout Time	(H Line Time) x (lines in frame + 23) — in µs	
Auto-Brightness	Yes , with Auto-Exposure and AGC (FPGA Gain or Sensor Gain)	
Black offset control	Yes (in DN)	
Gain Control	In-sensor Gain (1.0x to 251x) In-FPGA Digital Gain (1x to 4x) in 0.007x steps	
Binning Support	Yes In-FPGA (summing and average) 2x2, 4x4	
Decimation Support	No	
Color Correction Support	No	
Defective Pixel Replacement	No	
Image Correction	No	
Image Flip Support	Yes, In-Sensor, Vertical and Horizontal	
Multi-ROI Support	Yes, In-Sensor, up to 16 ROI (mutually exclusive with in-sensor binning)	
On-Board Image Memory	90MB	
Output Dynamic Range (dB)	56.7	75.4 dB (in 8-Bit Pixel Format)
SNR (dB)	33.01	39.6 dB (in 8-Bit Pixel Format)

*** Limited to the Genie Nano Architecture:**

~250MB/sec Sustained into the TurboDrive Engine achieved using 1500 Byte Packet Size

Firmware Files for Model M2050

The latest firmware files for all Nano models are available on the Teledyne DALSA support web site: <http://www.teledynedalsa.com/imaging/support/downloads/firmware/>

The firmware files for this model are listed below. The xx denotes the current build number.

M2050

- Standard
"Genie_Nano_Sony_IMX25x_3.2M-5.1M-9M-12M_Mono_STD_Firmware_7CA18.xx.cbf"
- High Sensitivity
"Genie_Nano_Sony_IMX25x_3.2M-5.1M-9M-12M_Mono_HSD_Firmware_7CA18.xx.cbf"

Specifications: C2050

Supported Features	Nano-C2050		
Resolution	2064 x 1544		
Sensor	Sony IMX252 (3.2M)		
Pixel Size	3.45 μm x 3.45 μm		
Shutter type	Full frame electronic global shutter function		
Firmware option (Field programmable)	High Sensitivity Design (Bayer)	Standard Design (Bayer)	RGB-Output Standard Design
Full Well charge; dependent on Firmware Design Loaded	2750e- (max)	11ke (max)	
Sensitivity to Saturation	4x	1x	
Max. Internal Frame Rate Full resolution	143 fps	116 fps	
Maximum Sustained Frame Rate Output (with TurboDrive v1) *	82 fps (8-bit)	82 fps (8-bit)	N/A
Maximum Sustained Frame Rate Output (without TurboDrive)	38 fps (8-bit)	38 fps (8-bit)	9.7 fps (RGBA) 14.5 fps (RGB) 19 fps (Yuv422) 38 fps (mono8)
Pixel Data Formats	Bayer 8-Bit	Bayer 8-Bit	RGBA 32-bit RGB 24-bit Yuv422 16-bit Mono 8-bit
Trigger to Exposure Minimum delay (Synchronous Exposure Alignment)	2 line time (8.8 μs)	2 line time (10.8 μs)	
Trigger to Exposure Minimum delay (Reset Exposure Alignment)	0 μs		
Trigger to Exposure Start jitter (best case with Synchronous Exposure Alignment)	Max 1 line (0 to 4.4 μs)	Max 1 line (0 to 5.4 μs)	
Trigger to Exposure Start jitter (Reset Exposure Alignment)	0 μs		
Actual Exposure Time Minimum (see "exposureTimeActual" in Sensor Control)	18.1 μs (1 line time+13.73 us) (increment of 4.4 μs steps)	19.1 μs (1 line time + 13.73 us) (increment of 5.4 μs steps)	
Min. Time from End of Exposure to Start of Next Exposure	10 lines–13.73 μs (30.3 μs)	10 lines–13.73 μs (40.4 μs)	
Horizontal Line Time:	4.4 μs	5.4 μs	
Readout Time	(H Line Time) x (lines in frame +23) — in μs		
Auto-Brightness	Yes , with Auto-Exposure and AGC (FPGA Gain or Sensor Gain)		
Black offset control	Yes (in DN)		
Gain Control	In-sensor Gain (1.0x to 251x) In-FPGA Digital Gain (1x to 4x) in 0.007x steps		
Binning Support	No		
Color Correction Support	No	Yes	
Decimation Support	No		
Defective Pixel Replacement	No		

Image Correction	No	
Image Flip Support	Yes, In-Sensor, Vertical and Horizontal	
Multi-ROI Support	Yes, In-Sensor, up to 16 ROI (mutually exclusive with in-sensor binning)	
On-Board Image Memory	90MB	
Output Dynamic Range (dB)	56.7	75.4 dB (in 8-Bit Pixel Format)
SNR (dB)	33.01	39.6 dB (in 8-Bit Pixel Format)

*** Limited to the Genie Nano Architecture:**

~250MB/sec Sustained into the TurboDrive Engine achieved using 1500 Byte Packet Size

Firmware Files for Model C2050

The latest firmware files for all Nano models are available on the Teledyne DALSA support web site: <http://www.teledynedalsa.com/imaging/support/downloads/firmware/>

The firmware files for this model are listed below. The xx denotes the current build number.

C2050

- Bayer Output
"Genie_Nano_Sony_IMX25x_3.2M-5.1M-9M-12M _Bayer_STD_Firmware_8CA18.xx.cbf"
- High Sensitivity Bayer Output
"Genie_Nano_Sony_IMX25x_3.2M-5.1M-9M-12M _Bayer_HSD_Firmware_8CA18.xx.cbf"
- RGB Output
"Genie_Nano_Sony_IMX25x_3.2M-5.1M-9M-12M _RGB_Output_Firmware_8CA18.xx.cbf"

Spectral Responses

The response curves describe the sensor, excluding lens and light source characteristics.

Models M2020, M2050

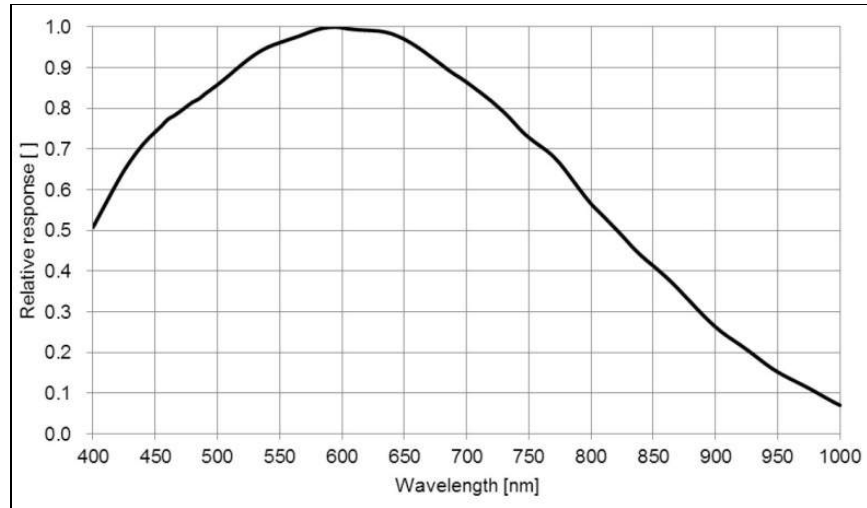

Models C2020, C2050

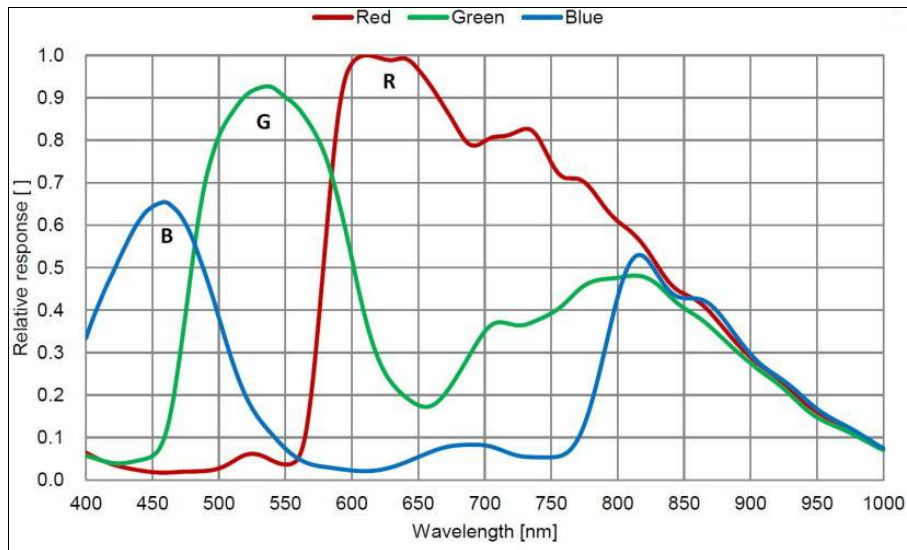

Specifications: M2420, C2420

Supported Features	Nano-M2420		Nano-C2420	
Resolution	2464x 2056			
Sensor	Sony IMX264 (5.1M)			
Pixel Size	3.45 μm x 3.45 μm			
Shutter type	Full frame electronic global shutter function			
Full Well charge	11ke (max)			
Firmware option (Field programmable)	Standard Design Monochrome	Standard Design Bayer	RGB-Output Design	
Max. Internal Frame Rate Full resolution	34.4 fps			
Maximum Sustained Frame Rate Output (with TurboDrive v1) *	34.4 fps (8-bit) 26.1 fps (12-bit)		N/A	
Maximum Sustained Frame Rate Output (without TurboDrive)	22.5 fps (8-bit) 11 fps (12-bit)		5.5 fps (RGBA) 8 fps (RGB) 11 fps (Yuv422) 22 fps (mono8)	
Pixel Data Formats	Mono 8-bit Mono 12-bit	Bayer 8-Bit Bayer 12-Bit	RGBA 32-bit RGB 24-bit Yuv422 16-bit Mono 8-bit	
Trigger to Exposure Minimum delay (Synchronous Exposure Alignment)	2 line time (27.8 μs)			
Trigger to Exposure Minimum delay (Reset Exposure Alignment)	0 μs			
Trigger to Exposure Start jitter (best case with Synchronous Exposure Alignment)	Up to 1 line time 0 to 13.9 μs			
Trigger to Exposure Start jitter (Reset Exposure Alignment)	0 μs			
Actual Exposure Time Minimum (see "exposureTimeActual" in Sensor Control)	27.65 μs (1 line time + 13.73 μs) (increment steps of 13.9 μs)			
Min. Time from End of Exposure to Start of Next Exposure (second frame)	8 lines (97.6 μs)			
Horizontal Line Time:	13.9 μs			
Readout Time	(Horizontal Line Time) x (lines in frame +17) — in μs			
Auto-Brightness	Yes , with Auto-Exposure and AGC (FPGA Gain or Sensor Gain)			
Black offset control	Yes (in DN)			
Gain Control	In-sensor Gain (1.0x to 251x) In-FPGA Digital Gain (1x to 4x) in 0.007x step			
Binning Support	Yes In-FPGA (summing and average) 2x2, 4x4	No		
Color Correction Support	No		Yes	
Decimation Support	No			
Defective Pixel Replacement	No			
Image Correction	No			
Image Flip Support	Yes, In-Sensor, Vertical and Horizontal			
Multi-ROI Support	Yes, in FPGA, up to 16 ROI (mutually exclusive with binning)			

On-Board Image Memory	90MB
Output Dynamic Range (dB)	76.8 dB (in 12-Bit Pixel Format)
SNR (dB)	39.5 dB (in 12-Bit Pixel Format)

*** Limited to the Genie Nano Architecture:**

~250MB/sec Sustained into the TurboDrive Engine achieved using 1500 Byte Packet Size

Firmware Files for Models 2420

The latest firmware files for all Nano models are available on the Teledyne DALSA support web site:
<http://www.teledynedalsa.com/imaging/support/downloads/firmware/>

The firmware files for these models are listed below. The xx denotes the current build number.

M2420

- Standard
"Genie_Nano_Sony_IMX264-265_3.2M-5.1M_Mono_STD_Firmware_9CA18.xx.cbf"

C2420

- Bayer Output
"Genie_Nano_Sony_IMX264-265_3.2M-5.1M_Bayer_STD_Firmware_ACA18.xx.cbf"
- RGB Output
"Genie_Nano_Sony_IMX264-265_3.2M-5.1M_RGB_Firmware_ACA18.xx.cbf"

Specifications: M2450

Supported Features	M2450	
Resolution	2464 x 2056	
Sensor	Sony IMX250 (5.1M)	
Pixel Size	3.45 μm x 3.45 μm	
Shutter type	Full frame electronic global shutter function	
Firmware option (Field programmable)	High Sensitivity Design	Standard Design (Mono)
Full Well charge; dependent on Firmware Design Loaded	2750e- (max)	11ke (max)
Sensitivity to Saturation	4x	1x
Max. Internal Frame Rate Full resolution	93 fps	76 fps
Maximum Sustained Frame Rate Output (with TurboDrive v1)*	49 fps (8-bit)	
Maximum Sustained Frame Rate Output (without TurboDrive)	22 fps (8-bit)	
Pixel Data Formats	Mono 8-bit	
Trigger to Exposure Minimum delay (Synchronous Exposure Alignment)	2 line time (10.22 μs)	2 line time (12.5 μs)
Trigger to Exposure Minimum delay (Reset Exposure Alignment)	0 μs	
Trigger to Exposure Start jitter (best case with Synchronous Exposure Alignment)	Max 1 line (0 to 5.11 μs)	Max 1 line (0 to 6.25 μs)

Trigger to Exposure Start jitter (Reset Exposure Alignment)	0 μ s	
Actual Exposure Time Minimum (see "exposureTimeActual" in Sensor Control)	18.8 μ s (1 line time + 13.73 us) (increment of 5.11 μ s steps)	19.9 μ s (1 line time + 13.73 us) (increment of 6.2 μ s steps)
Min. Time from End of Exposure to Start of Next Exposure	10 lines–13.73 μ s (37.3 μ s)	10 lines–13.73 μ s (48.8 μ s)
Horizontal Line Time:	5.11 μ s	6.2 μ s
Readout Time	(H Line Time) x (lines in frame + 23) — in μ s	
Auto-Brightness	Yes , with Auto-Exposure and AGC (FPGA Gain or Sensor Gain)	
Black offset control	Yes (in DN)	
Gain Control	In-sensor Analog Gain (1.0x to 251x)	
Binning Support	Yes In-FPGA (summing and average) 2x2, 4x4	
Decimation Support	No	
Defective Pixel Replacement	No	
Image Correction	no	
Image Flip Support	Yes, In-Sensor, Vertical and Horizontal	
Multi-ROI Support	Yes, In-Sensor, up to 16 ROI (mutually exclusive with in-sensor binning)	
On-Board Image Memory	90MB	
Output Dynamic Range (dB)	56.7	75.4 dB (in 8-Bit Pixel Format)
SNR (dB)	33.01	39.6 dB (in 8-Bit Pixel Format)

* **Limited to the Genie Nano Architecture:**

~250MB/sec Sustained into the TurboDrive Engine achieved using 1500 Byte Packet Size

Firmware Files for Model M2450

The latest firmware files for all Nano models are available on the Teledyne DALSA support web site:
<http://www.teledynedalsa.com/imaging/support/downloads/firmware/>

The firmware files for this model are listed below. The xx denotes the current build number.

M2450

- Standard
"Genie_Nano_Sony_IMX25x_3.2M-5.1M-9M-12M_Mono_STD_Firmware_7CA18.xx.cbf"
- High Sensitivity
"Genie_Nano_Sony_IMX25x_3.2M-5.1M-9M-12M_Mono_HSD_Firmware_7CA18.xx.cbf"

Specifications: C2450

Supported Features	C2450		
Resolution	2464 x 2056		
Sensor	Sony IMX250 (5.1M)		
Pixel Size	3.45 μm x 3.45 μm		
Shutter type	Full frame electronic global shutter function		
Firmware option (Field programmable)	High Sensitivity Design (Bayer)	Standard Design (Bayer)	RGB-Output Design
Full Well charge; dependent on Firmware Design Loaded	2750e- (max)	11ke (max)	
Sensitivity to Saturation	4x	1x	
Max. Internal Frame Rate Full resolution	93 fps	76 fps	
Maximum Sustained Frame Rate Output (with TurboDrive v1)*	49 fps (8-bit)	49 fps (8-bit)	N/A
Maximum Sustained Frame Rate Output (without TurboDrive)	22 fps (8-bit)	22 fps (8-bit)	5.5 fps (RGBA) 8.7 fps (RGB) 11 fps (Yuv422) 22 fps (mono8)
Pixel Data Formats	Bayer 8-Bit	Bayer 8-Bit	RGBA 32-bit RGB 24-bit Yuv422 16-bit Mono 8-bit
Trigger to Exposure Minimum delay (Synchronous Exposure Alignment)	2 line time (10.22 μs)	2 line time (12.5 μs)	
Trigger to Exposure Minimum delay (Reset Exposure Alignment)	0 μs		
Trigger to Exposure Start jitter (best case with Synchronous Exposure Alignment)	Max 1 line (0 to 5.11 μs)	Max 1 line (0 to 6.25 μs)	
Trigger to Exposure Start jitter (Reset Exposure Alignment)	0 μs		
Actual Exposure Time Minimum (see "exposureTimeActual" in Sensor Control)	18.8 μs (1 line time+13.73 us) (increment of 5.11 μs steps)	19.9 μs (1 line time + 13.73 us) (increment of 6.2 μs steps)	
Min. Time from End of Exposure to Start of Next Exposure	10 lines–13.73 μs (37.3 μs)	10 lines–13.73 μs (48.8 μs)	
Horizontal Line Time:	5.11 μs	6.2 μs	
Readout Time	(H Line Time) x (lines in frame +23) — in μs		
Auto-Brightness	Yes , with Auto-Exposure and AGC (FPGA Gain or Sensor Gain)		
Black offset control	Yes (in DN)		
Gain Control	In-sensor Analog Gain (1.0x to 251x)		
Binning Support	No		
Color Correction Support	No	Yes	
Decimation Support	No		
Defective Pixel Replacement	No		
Image Correction	no		

Image Flip Support	Yes, In-Sensor, Vertical and Horizontal	
Multi-ROI Support	Yes, In-Sensor, up to 16 ROI (mutually exclusive with in-sensor binning)	
On-Board Image Memory	90MB	
Output Dynamic Range (dB)	56.7	75.4 dB (in 8-Bit Pixel Format)
SNR (dB)	33.01	39.6 dB (in 8-Bit Pixel Format)

*** Limited to the Genie Nano Architecture:**

~250MB/sec Sustained into the TurboDrive Engine achieved using 1500 Byte Packet Size

Firmware Files for Model C2450

The latest firmware files for all Nano models are available on the Teledyne DALSA support web site: <http://www.teledynedalsa.com/imaging/support/downloads/firmware/>

The firmware files for this model are listed below. The xx denotes the current build number.

C2450

- Bayer Output
"Genie_Nano_Sony_IMX25x_3.2M-5.1M-9M-12M _Bayer_STD_Firmware_8CA18.xx.cbf"
- High Sensitivity Bayer Output
"Genie_Nano_Sony_IMX25x_3.2M-5.1M-9M-12M _Bayer_HSD_Firmware_8CA18.xx.cbf"
- RGB Output
"Genie_Nano_Sony_IMX25x_3.2M-5.1M-9M-12M _RGB_Output_Firmware_8CA18.xx.cbf"

Spectral Responses

The response curves describe the sensor, excluding lens and light source characteristics.

Models M2450

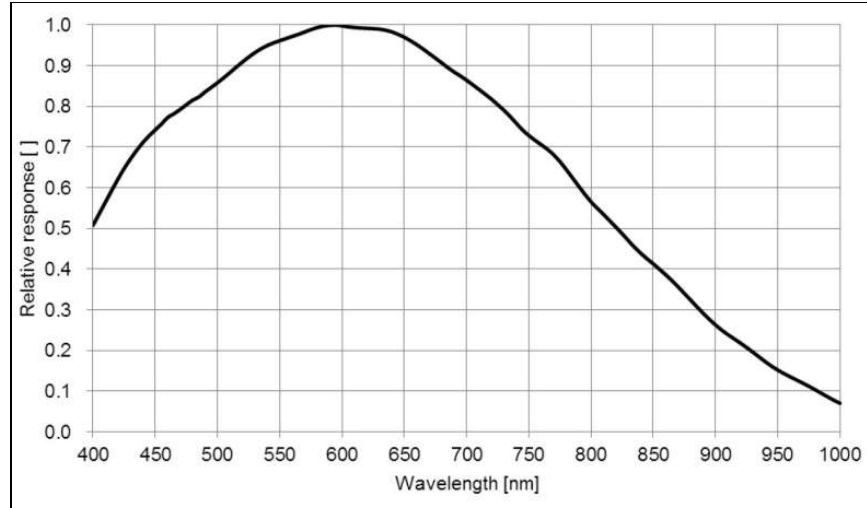

Models C2450

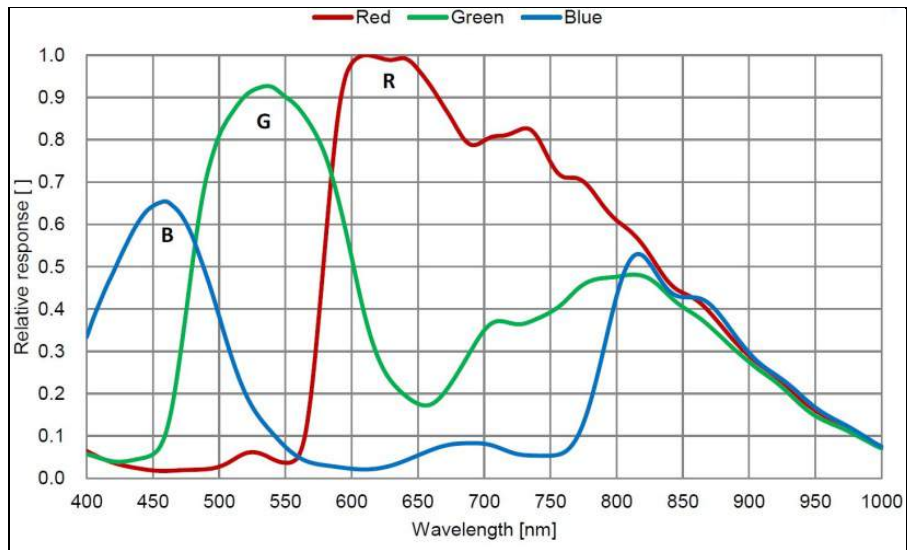

Specifications: M4060

Supported Features	M4060	
Resolution	4112 x 2176	
Sensor	Sony IMX255 (8.9M)	
Pixel Size	3.45 μm x 3.45 μm	
Shutter type	Full frame electronic global shutter function	
Firmware option (Field programmable)	High Sensitivity Design Firmware	Standard Design Firmware
Full Well charge; dependent on Firmware Design Loaded	2750e ⁻ (max)	11ke (max)
Sensitivity to Saturation	4x	1x
Max. Internal Frame Rate Full resolution	56 fps	46 fps
Maximum Sustained Frame Rate Output (with TurboDrive v1)*	28 fps (8-bit)	
Maximum Sustained Frame Rate Output (without TurboDrive)	13 fps (8-bit)	
Pixel Data Formats	Mono 8-bit	
Trigger to Exposure Minimum delay (Synchronous Exposure Alignment)	2 line time (15.8 μs)	2 line time (19.5 μs)
Trigger to Exposure Minimum delay (Reset Exposure Alignment)	0 μs	
Trigger to Exposure Start jitter (best case with Synchronous Exposure Alignment)	Max 1 line 0 to 7.89 μs	Max 1 line 0 to 9.72 μs
Trigger to Exposure Start jitter (Reset Exposure Alignment)	0 μs	
Actual Exposure Time Minimum (see "exposureTimeActual" in Sensor Control)	22 μs (1 line time + 14.26 us) (increment of 7.89 μs steps)	24 μs (1 line time + 14.26 us) (increment of 9.72 μs steps)
Min. Time from End of Exposure to Start of Next Exposure	16 lines – 14.26 μs (112 μs)	16 lines – 14.26 μs (141.3 μs)
Horizontal Line Time: Normal operation (with In-Sensor Binning enable)	7.89 μs (4.95 μs)	9.72 μs (5.27 μs)
Readout Time	(H Line Time) x (lines in frame +39) in μs	
Auto-Brightness	Yes , with Auto-Exposure and AGC (FPGA Gain or Sensor Gain)	
Black offset control	Yes (in DN)	
Gain Control	In-sensor Analog Gain (1.0x to 251x)	
Binning Support	Yes, In-sensor 2x2 (averaging) Yes In-FPGA (summing and average, 2x2, 4x4)	
Decimation Support	No	
Defective Pixel Replacement	Yes , up to 512 pixel position	
Image Correction	no	
Image Flip Support	Yes, In-Sensor, Vertical and Horizontal	
Multi-ROI Support	Yes, In-Sensor, up to 16 ROI (mutually exclusive with in-sensor binning)	
On-Board Image Memory	220MB	

Output Dynamic Range (dB)	56.43	76.46 dB (in 8-Bit Pixel Format)
SNR (dB)	33.01	39.38 dB (in 8-Bit Pixel Format)

*** Limited to the Genie Nano Architecture:**

~250MB/sec Sustained into the TurboDrive Engine achieved using 1500 Byte Packet Size

Firmware Files for Model M4060

The latest firmware files for all Nano models are available on the Teledyne DALSA support web site:

<http://www.teledynedalsa.com/imaging/support/downloads/firmware/>

The firmware files for this model are listed below. The xx denotes the current build number.

M4060

- Standard
"Genie_Nano_Sony_IMX25x_3.2M-5.1M-9M-12M_Mono_STD_Firmware_7CA18.xx.cbf"
- High Sensitivity
"Genie_Nano_Sony_IMX25x_3.2M-5.1M-9M-12M_Mono_HSD_Firmware_7CA18.xx.cbf"

Specifications: C4060

Supported Features	C4060		
Resolution	4112 x 2176		
Sensor	Sony IMX255 (8.9M)		
Pixel Size	3.45 μ m x 3.45 μ m		
Shutter type	Full frame electronic global shutter function		
Firmware option (Field programmable)	High Sensitivity Design (Bayer)	Standard Design (Bayer)	RGB-Output Design
Full Well charge; dependent on Firmware Design Loaded	2750e- (max)	11ke (max)	
Sensitivity to Saturation	4x	1x	
Max. Internal Frame Rate Full resolution	56 fps	46 fps	
Maximum Sustained Frame Rate Output (with TurboDrive v1)*	28 fps (8-bit)		N/A
Maximum Sustained Frame Rate Output (without TurboDrive)	13 fps (8-bit)		3.2fps (RGBA) 4.3 fps (RGB) 6.5 fps (Yuv422) 13 fps (mono8)
Pixel Data Formats	Bayer 8-Bit	Bayer 8-Bit	RGBA 32-bit RGB 24-bit Yuv422 16-bit Mono 8-bit
Trigger to Exposure Minimum delay (Synchronous Exposure Alignment)	2 line time (15.8 μ s)	2 line time (19.5 μ s)	
Trigger to Exposure Minimum delay (Reset Exposure Alignment)	0 μ s		
Trigger to Exposure Start jitter (best case with Synchronous Exposure Alignment)	Max 1 line 0 to 7.89 μ s	Max 1 line 0 to 9.72 μ s	
Trigger to Exposure Start jitter (Reset Exposure Alignment)	0 μ s		

Actual Exposure Time Minimum (see "exposureTimeActual" in Sensor Control)	22µs (1 line time + 14.26 us) (in 7.89µs steps)	24µs (1 line time + 14.26 us) (in 9.72µs steps)
Min. Time from End of Exposure to Start of Next Exposure	16 lines – 14.26µs (112µs)	16 lines – 14.26µs (141.3µs)
Horizontal Line Time: Normal operation (with In-Sensor Binning enable)	7.89µs (4.95µs)	9.72µs (5.27µs)
Readout Time	(H Line Time) x (lines in frame +39) in µs	
Auto-Brightness	Yes , with Auto-Exposure and AGC (FPGA Gain or Sensor Gain)	
Black offset control	Yes (in DN)	
Gain Control	In-sensor Analog Gain (1.0x to 251x)	
Binning Support	No	
Color Correction Support	No	Yes
Decimation Support	No	
Defective Pixel Replacement	Yes , up to 512 pixel position	
Image Correction	no	
Image Flip Support	Yes, In-Sensor, Vertical and Horizontal	
Multi-ROI Support	Yes, In-Sensor, up to 16 ROI (mutually exclusive with in-sensor binning)	
On-Board Image Memory	220MB	
Output Dynamic Range (dB)	56.43	76.46 dB (in 8-Bit Pixel Format)
SNR (dB)	33.01	39.38 dB (in 8-Bit Pixel Format)

* **Limited to the Genie Nano Architecture:**

~250MB/sec Sustained into the TurboDrive Engine achieved using 1500 Byte Packet Size

Firmware Files for Model C4060

The latest firmware files for all Nano models are available on the Teledyne DALSA support web site:

<http://www.teledynedalsa.com/imaging/support/downloads/firmware/>

The firmware files for this model are listed below. The xx denotes the current build number.

C4060

- Bayer Output
"Genie_Nano_Sony_IMX25x_3.2M-5.1M-9M-12M _Bayer_STD_Firmware_8CA18.xx.cbf"
- High Sensitivity Bayer Output
"Genie_Nano_Sony_IMX25x_3.2M-5.1M-9M-12M _Bayer_HSD_Firmware_8CA18.xx.cbf"
- RGB Output
"Genie_Nano_Sony_IMX25x_3.2M-5.1M-9M-12M _RGB_Firmware_8CA18.xx.cbf"

Specifications: M4040

Supported Features	M4040	
Resolution	4112 x 3008	
Sensor	Sony IMX253 (12M)	
Pixel Size	3.45 μm x 3.45 μm	
Shutter type	Full frame electronic global shutter function	
Firmware option (Field programmable)	High Sensitivity Design	Standard Design (Mono)
Full Well charge; dependent on Firmware Design Loaded	2750e ⁻ (max)	11ke (max)
Sensitivity to Saturation	4x	1x
Max. Internal Frame Rate Full resolution	41 fps	33 fps
Maximum Sustained Frame Rate Output (with TurboDrive v1) *	21 fps (8-bit)	
Maximum Sustained Frame Rate Output (without TurboDrive)	9.7 fps (8-bit)	
Pixel Data Formats	Mono 8-bit	
Trigger to Exposure Minimum delay (Synchronous Exposure Alignment)	2 line time (15.8 μs)	2 line time (19.5 μs)
Trigger to Exposure Minimum delay (Reset Exposure Alignment)	0 μs	
Trigger to Exposure Start jitter (best case with Synchronous Exposure Alignment)	Max 1 line 0 to 7.89 μs	Max 1 line 0 to 9.72 μs
Trigger to Exposure Start jitter (Reset Exposure Alignment)	0 μs	
Actual Exposure Time Minimum (see "exposureTimeActual" in Sensor Control)	22 μs (1 line time + 14.26 us) (increment of 7.89 μs steps)	24 μs (1 line time + 14.26 us) (increment of 9.72 μs steps)
Min. Time from End of Exposure to Start of Next Exposure	16 lines – 14.26 μs (112 μs)	16 lines – 14.26 μs (141.3 μs)
Horizontal Line Time: Normal operation (with In-Sensor Binning enabled)	7.89 μs (4.95 μs)	9.72 μs (5.27 μs)
Readout Time	(H Line Time) x (lines in frame +39) in μs	
Auto-Brightness	Yes , with Auto-Exposure and AGC (FPGA Gain or Sensor Gain)	
Black offset control	Yes (in DN)	
Gain Control	In-sensor Analog Gain (1.0x to 251x)	
Binning Support	Yes In-FPGA (summing and average, 2x2, 4x4) Yes, In-sensor 2x2 (averaging)	
Decimation Support	No	
Defective Pixel Replacement	Yes , up to 512 pixel position	
Image Correction	no	
Image Flip Support	Yes, In-Sensor, Vertical and Horizontal	
Multi-ROI Support	Yes, In-Sensor, up to 16 ROI (mutually exclusive with in-sensor binning)	

On-Board Image Memory	220MB	
Output Dynamic Range (dB)	56.43	76.46 dB (in 8-Bit Pixel Format)
SNR (dB)	32.01	39.50 dB (in 8-Bit Pixel Format)

*** Limited to the Genie Nano Architecture:**

~250MB/sec Sustained into the TurboDrive Engine achieved using 1500 Byte Packet Size

Firmware Files for Model M4040

The latest firmware files for all Nano models are available on the Teledyne DALSA support web site: <http://www.teledynedalsa.com/imaging/support/downloads/firmware/>

The firmware files for this model are listed below. The xx denotes the current build number.

M4040

- Standard
"Genie_Nano_Sony_IMX25x_3.2M-5.1M-9M-12M_Mono_STD_Firmware_7CA18.xx.cbf"
- High Sensitivity
"Genie_Nano_Sony_IMX25x_3.2M-5.1M-9M-12M_Mono_HSD_Firmware_7CA18.xx.cbf"

Specifications: C4040

Supported Features	C4040		
Resolution	4112 x 3008		
Sensor	Sony IMX253 (12M)		
Pixel Size	3.45 μm x 3.45 μm		
Shutter type	Full frame electronic global shutter function		
Firmware option (Field programmable)	High Sensitivity Design (Bayer)	Standard Design (Bayer)	RGB-Output Design
Full Well charge; dependent on Firmware Design Loaded	2750e- (max)	11ke (max)	
Sensitivity to Saturation	4x	1x	
Max. Internal Frame Rate Full resolution	41 fps	33 fps	
Maximum Sustained Frame Rate Output (with TurboDrive v1) *	21 fps (8-bit)		N/A
Maximum Sustained Frame Rate Output (without TurboDrive)	9.7 fps (8-bit)		2.4fps (RGBA) 3.2fps (RGB) 4.3fps (Yuv422) 9.7fps (mono8)
Pixel Data Formats	Bayer 8-bit	Bayer 8-Bit	RGBA 32-bit RGB 24-bit Yuv422 16-bit Mono 8-bit
Trigger to Exposure Minimum delay (Synchronous Exposure Alignment)	2 line time (15.8 μs)	2 line time (19.5 μs)	
Trigger to Exposure Minimum delay (Reset Exposure Alignment)	0 μs		

Trigger to Exposure Start jitter (best case with <i>Synchronous Exposure Alignment</i>)	Max 1 line 0 to 7.89µs	Max 1 line 0 to 9.72µs
Trigger to Exposure Start jitter (<i>Reset Exposure Alignment</i>)	0 µs	
Actual Exposure Time Minimum (see "exposureTimeActual" in Sensor Control)	22µs (1 line time + 14.26 us) (increment of 7.89µs steps)	24µs (1 line time + 14.26 us) (increment of 9.72µs steps)
Min. Time from End of Exposure to Start of Next Exposure	16 lines – 14.26µs (112µs)	16 lines – 14.26µs (141.3µs)
Horizontal Line Time: Normal operation (with In-Sensor Binning enable)	7.89µs (4.95µs)	9.72µs (5.27µs)
Readout Time	(H Line Time) x (lines in frame +39) in µs	
Auto-Brightness	Yes , with Auto-Exposure and AGC (FPGA Gain or Sensor Gain)	
Black offset control	Yes (in DN)	
Gain Control	In-sensor Analog Gain (1.0x to 251x)	
Binning Support	No	
Color Correction Support	No	Yes
Decimation Support	No	
Defective Pixel Replacement	Yes , up to 512 pixel position	
Image Correction	no	
Image Flip Support	Yes, In-Sensor, Vertical and Horizontal	
Multi-ROI Support	Yes, In-Sensor, up to 16 ROI (mutually exclusive with in-sensor binning)	
On-Board Image Memory	220MB	
Output Dynamic Range (dB)	56.43	76.46 dB (in 8-Bit Pixel Format)
SNR (dB)	32.01	39.50 dB (in 8-Bit Pixel Format)

*** Limited to the Genie Nano Architecture:**

~250MB/sec Sustained into the TurboDrive Engine achieved using 1500 Byte Packet Size

Firmware Files for Model C4040

The latest firmware files for all Nano models are available on the Teledyne DALSA support web site: <http://www.teledynedalsa.com/imaging/support/downloads/firmware/>

The firmware files for this model are listed below. The xx denotes the current build number.

C4040

- Bayer Output
"Genie_Nano_Sony_IMX25x_3.2M-5.1M-9M-12M _Bayer_STD_Firmware_8CA18.xx.cbf"
- High Sensitivity Bayer Output
"Genie_Nano_Sony_IMX25x_3.2M-5.1M-9M-12M _Bayer_HSD_Firmware_8CA18.xx.cbf"
- RGB Output
"Genie_Nano_Sony_IMX25x_3.2M-5.1M-9M-12M _RGB_Firmware_8CA18.xx.cbf"

Spectral Responses 4060 & 4040

The response curves describe the sensor, excluding lens and light source characteristics.

Models M4060, M4040

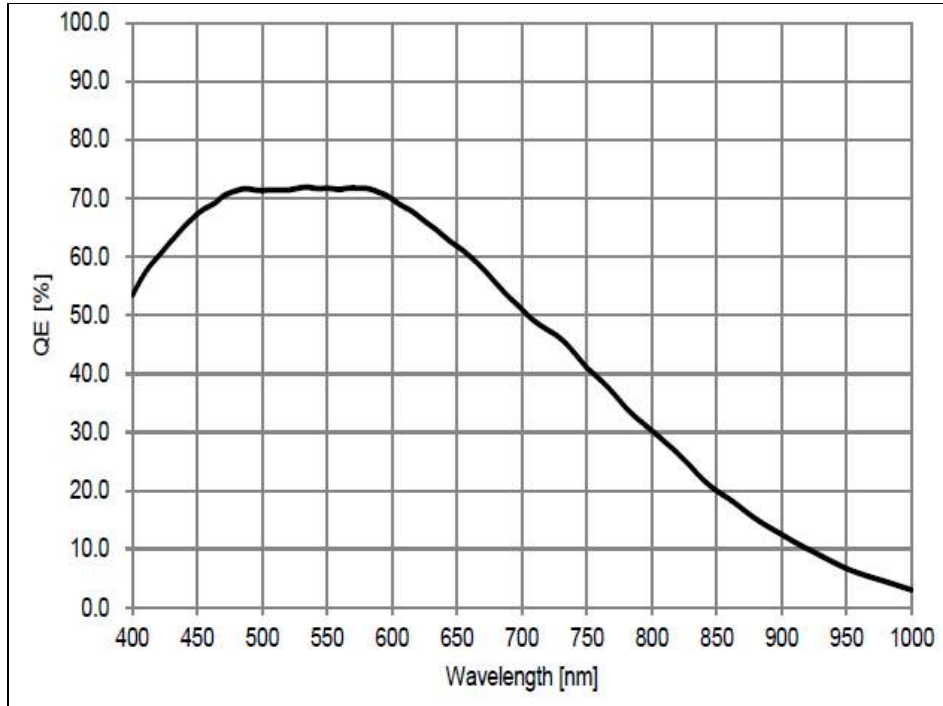

Models C4060, C4040

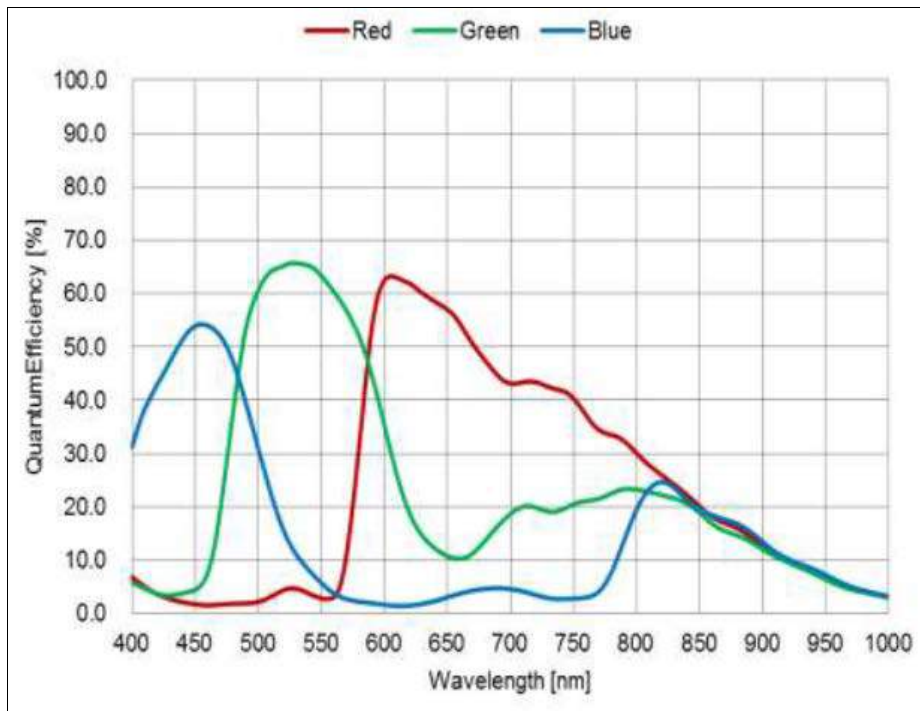

Specifications: M4030, C4030

Supported Features	M4030	C4030	
Resolution	4112 x 2176		
Sensor	Sony IMX267 (8.9M)		
Pixel Size	3.45 μm x 3.45 μm		
Shutter type	Full frame electronic global shutter function		
Full Well charge	11ke (max)		
Firmware option (Field programmable)	Standard Design Monochrome	Standard Design Bayer	RGB-Output Design
Max. Internal Frame Rate Full resolution	30.1 fps		
Maximum Sustained Frame Rate Output (with TurboDrive v1) *	29.6 fps (8-bit) 14.8 fps (12-bit)		N/A
Maximum Sustained Frame Rate Output (without TurboDrive)	13 fps (8-bit) 6.5 fps (12-bit)		3 fps (RGBA) 5 fps (RGB) 6.5 fps (Yuv422) 13 fps (mono8)
Pixel Data Formats	Mono 8-bit Mono 12-bit	Bayer 8-Bit Bayer 12-Bit	RGBA 32-bit RGB 24-bit Yuv422 16-bit Mono 8-bit
Trigger to Exposure Minimum delay (Synchronous Exposure Alignment)	2 line time (30 μs)		2 line time (44.84 μs)
Trigger to Exposure Minimum delay (Reset Exposure Alignment)	0 μs		
Trigger to Exposure Start jitter (best case with Synchronous Exposure Alignment)	Up to 1 line time 0 to 15 μs		Up to 1 line time 0 to 22.42 μs
Trigger to Exposure Start jitter (Reset Exposure Alignment)	0 μs		
Exposure Time Minimum (see "exposureTimeActual" in Sensor Control)	29.26 μs (1 line time + 14.26 us) (increment steps of 15μs)		36.68 μs (1 line time + 14.26 us) (increment steps of 22.42 μs)
Min. Time from End of Exposure to Start of Next Exposure	10 lines (150 μs)		10 lines (224.2 μs)
Horizontal Line Time:	15μs		22.42 μs
Readout Time	(Horizontal Line Time) x (lines in frame +19) — in μs		
Auto-Brightness	Yes , with Auto-Exposure and AGC (FPGA Gain or Sensor Gain)		
Black offset control	Yes (in DN)		
Gain Control	In-sensor Gain (1.0x to 251x) In-FPGA Digital Gain (1x to 4x) in 0.007x step		
Binning Support	Yes In-FPGA (summing and average) 2x2, 4x4	No	
Color Correction Support	No		Yes
Decimation Support	No		
Defective Pixel Replacement	Yes, up to 512 positions		
Image Correction	No		

Image Flip Support	Yes, In-Sensor, Vertical and Horizontal
Multi-ROI Support	Yes, in FPGA, up to 16 ROI (mutually exclusive with binning)
On-Board Image Memory	220MB
Output Dynamic Range (dB)	76.4 dB (in 12-Bit Pixel Format)
SNR (dB)	39.6 dB (in 12-Bit Pixel Format)

* **Limited to the Genie Nano Architecture:**

~250MB/sec Sustained into the TurboDrive Engine achieved using 1500 Byte Packet Size

Specifications: M4020, C4020

Supported Features	M4020	C4020	
Resolution	4112 x 3008		
Sensor	Sony IMX304 (12M)		
Pixel Size	3.45 μm x 3.45 μm		
Shutter type	Full frame electronic global shutter function		
Full Well charge	11ke (max)		
Firmware option (Field programmable)	Standard Design Monochrome	Standard Design Bayer	RGB-Output Design
Max. Internal Frame Rate Full resolution	21.9 fps		
Maximum Sustained Frame Rate Output (with TurboDrive v1) *	21.4 fps (8-bit) 10.7 fps (12-bit)		N/A
Maximum Sustained Frame Rate Output (without TurboDrive)	9.5 fps (8-bit) 4.5 fps (12-bit)		2.2 fps (RGBA) 3.4 fps (RGB) 4.5 fps (Yuv422) 9 fps (mono8)
Pixel Data Formats	Mono 8-bit Mono 12-bit	Bayer 8-Bit Bayer 12-Bit	RGBA 32-bit RGB 24-bit Yuv422 16-bit Mono 8-bit
Trigger to Exposure Minimum delay (Synchronous Exposure Alignment)	2 line time (30 μs)		2 line time (44.84 μs)
Trigger to Exposure Minimum delay (Reset Exposure Alignment)	0 μs		
Trigger to Exposure Start jitter (best case with Synchronous Exposure Alignment)	Up to 1 line time 0 to 15 μs		Up to 1 line time 0 to 22.42 μs
Trigger to Exposure Start jitter (Reset Exposure Alignment)	0 μs		
Exposure Time Minimum (see "exposureTimeActual" in Sensor Control)	29.26 μs (1 line time + 14.26 us) (increment steps of 15 μs)		36.68 μs (1 line time + 14.26 us) (increment steps of 22.42 μs)
Min. Time from End of Exposure to Start of Next Exposure	10 lines (150 μs)		10 lines (224.2 μs)
Horizontal Line Time:	15 μs		22.42 μs
Readout Time	(Horizontal Line Time) x (lines in frame + 19) — in μs		
Auto-Brightness	Yes , with Auto-Exposure and AGC (FPGA Gain or Sensor Gain)		
Black offset control	Yes (in DN)		

Gain Control	In-sensor Gain (1.0x to 251x) In-FPGA Digital Gain (1x to 4x) in 0.007x step	
Binning Support	Yes In-FPGA (summing and average) 2x2, 4x4	No
Color Correction Support	No	Yes
Decimation Support	No	
Defective Pixel Replacement	Yes, up to 512 positions	
Image Correction	No	
Image Flip Support	Yes, In-Sensor, Vertical and Horizontal	
Multi-ROI Support	Yes, in FPGA, up to 16 ROI (mutually exclusive with binning)	
On-Board Image Memory	220MB	
Output Dynamic Range (dB)	76.4 dB	
SNR (dB)	39.6 dB	

* Limited to the Genie Nano Architecture:

~250MB/sec Sustained into the TurboDrive Engine achieved using 1500 Byte Packet Size

Firmware Files for Model 4030 & 4020

The latest firmware files for all Nano models are available on the Teledyne DALSA support web site:
<http://www.teledynedalsa.com/imaging/support/downloads/firmware/>

The firmware files for these models are listed below. The xx denotes the current build number.

M4020 & M4030

- Standard
"Genie_Nano_Sony_IMX267-304_9M-12M_Mono_STD_Firmware_ECA18.xx.cbf"

C4020 & C4030

- Bayer Output
"Genie_Nano_Sony_IMX267-304_9M-12M_Bayer_STD_Firmware_FCA18.xx.cbf"
- RGB Output
"Genie_Nano_Sony_IMX267-304_9M-12M_RGB_Output_Firmware_FCA18.xx.cbf"

Spectral Response

The response curves describe the sensor, excluding lens and light source characteristics.

Models M4030, M4020

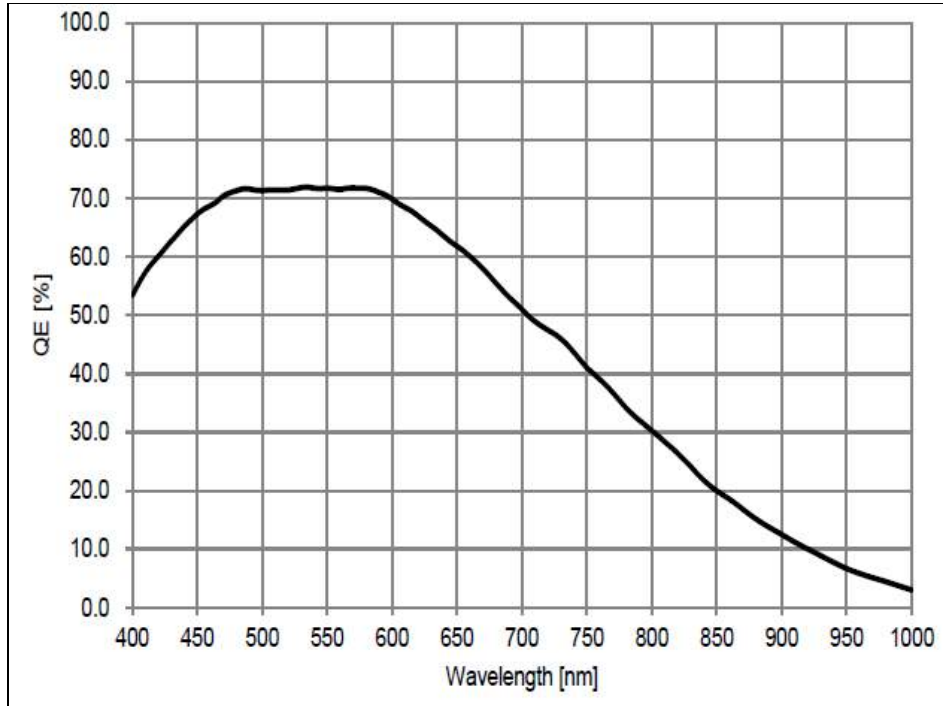

Models C4030, C4020

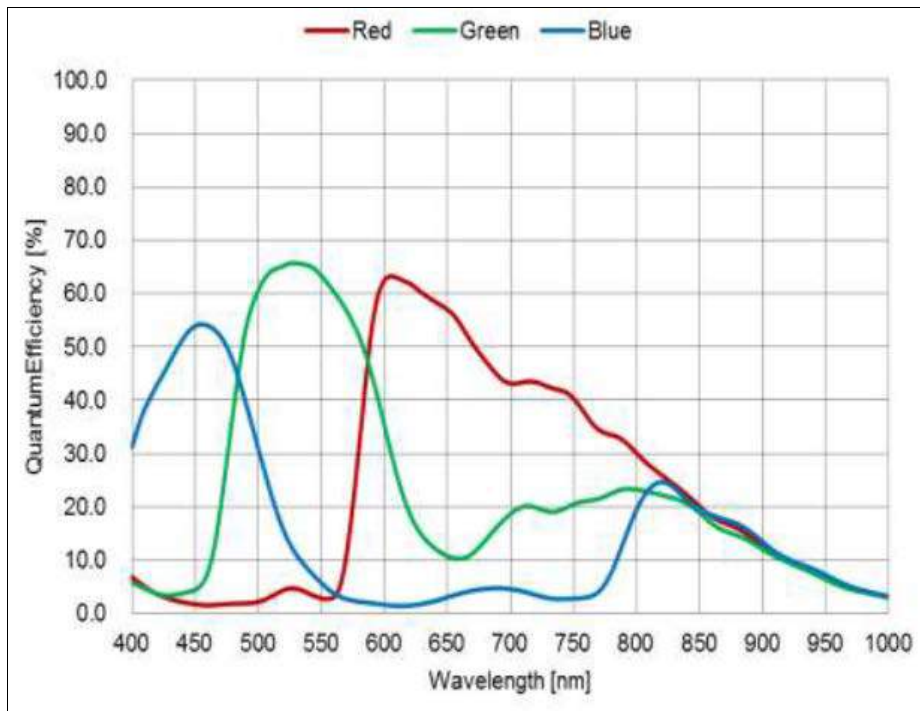

On-Semi Sensor Models

Genie Nano cameras utilizing On-Semi sensors (monochrome and color) are described.

Specifications: M640, M640-NIR, C640

Supported Features	M640, M640-NIR	C640	
Resolution	672 x 512		
Sensor	OnSemi Python300 P1 (0.3M)		
Pixel Size	4.8 μm x 4.8 μm		
Shutter type	Full frame electronic global shutter function		
Full Well charge	10ke (max)		
Firmware option (Field programmable)	Standard Design Monochrome	Standard Design Bayer	RGB-Output Design
Max. Internal Frame Rate	862 fps at 640 x 480 (Fast Readout Enable) 603 fps at 640 x 480 (Normal Readout Enable)		
Maximum Sustained Frame Rate Output (with TurboDrive v1)	720 fps (8-bit) 360 fps (10-bit)		N/A
Maximum Sustained Frame Rate Output (without TurboDrive)	345 fps (8-bit) 172 fps (10-bit)		86 fps (RGBA) 115 fps (RGB) 172 fps (Yuv422) 345 fps (8-bit mono)
Pixel Data Formats	Mono 8-bit Mono 10-bit	Bayer 8-Bit Bayer 10-Bit	RGBA 32-bit RGB 24-bit Yuv422 16-bit Mono 8-bit
Trigger to Exposure Minimum delay (Synchronous Exposure Alignment)	4 μs if exposureAlignment = Synchronous With No Overlap between the new exposure and the previous readout 26.2 μs if exposureAlignment = Synchronous With Overlap between the new exposure and the previous readout		
Trigger to Exposure Minimum delay (Reset Exposure Alignment)	4 μs		
Trigger to Exposure Start jitter (best case with Synchronous Exposure Alignment)	Up to 1 line time		
Trigger to Exposure Start jitter (Reset Exposure Alignment) *	0 μs		
Exposure Time Minimum (see "exposureTimeActual" in Sensor Control)	34 μs (increment steps of 1 μs)		
Min. Time from End of Exposure to Start of Next Exposure (second frame)	19 μs – Normal Readout 18 μs – Fast Readout		
Horizontal Line Time:	3.3 μs – Normal Readout 2.28 μs – Fast Readout		

Readout Time	1602 μ s – Normal Readout for 640 x 480 Add 75 μ s when overlapping Exposure and Readout 1107 μ s – Fast Readout for 640 x 480 Add 62 μ s when overlapping Exposure and Readout <i>Specifically: (Horizontal line time at current resolution * number of lines) + (3 * (line time of the 1280 model))</i>	
Auto-Brightness	Yes , with Auto-Exposure and AGC (FPGA Gain)	
Black offset control	Yes (in DN)	
Gain Control	In-sensor Analog Gain (1.0x to 8x) in 11 gain steps (1.0, 1.14, 1.33, 1.6, 2.0, 2.29, 2.67, 3.2, 4.0, 5.33, 8.0) In-sensor Digital Gain (1x to 32x) in 0.01x steps In-FPGA Digital Gain (1x to 4x) in 0.007x steps	
Binning Support	Yes In-FPGA (summing and average, 2x2, 4x4) Yes In- Sensor (averaging 2x2)	No
Color Correction Support	No	Yes
Decimation Support	No	
Defective Pixel Replacement	Yes, up to 512 positions	
Image Correction	Yes, Sensor FPN correction feature	
Image Flip Support	Yes, In-Sensor, Vertical Only	
Multi-ROI Support	Yes, in Sensor, up to 16 ROI (mutually exclusive with binning)	
On-Board Image Memory	90MB	
Output Dynamic Range (dB)	61.56 dB (in 10-Bit Pixel Format)	
SNR (dB)	39.8 dB (in 10-Bit Pixel Format)	

* Note: The actual internal minimum exposure may be different than what is programmed. Use the feature "exposureTimeActual" from the [Sensor Control](#) category to read back the actual sensor exposure. The exposure start sensor event is delayed 4 μ s from the actual start.

Specifications: M800, M800-NIR, C800

Supported Features	M800, M800-NIR	C800	
Resolution	832 x 632		
Sensor	OnSemi Python500 P1 (0.5M)		
Pixel Size	4.8 μ m x 4.8 μ m		
Shutter type	Full frame electronic global shutter function		
Full Well charge	10ke (max)		
Firmware option (Field programmable)	Standard Design Monochrome	Standard Design Bayer	RGB-Output Design
Max. Internal Frame Rate	566 fps at 800 x 600 (Fast Readout Enable) 419 fps at 800 x 600 (Normal Readout Enable)		
Maximum Sustained Frame Rate Output (with TurboDrive v1)	461 fps (8-bit) 230 fps (10-bit)		N/A
Maximum Sustained Frame Rate Output (without TurboDrive)	221 fps (8-bit) 110 fps (10-bit)		55 fps (RGBA) 73 fps (RGB) 110 fps (Yuv422) 221 fps (8-bit mono)

Pixel Data Formats	Mono 8-bit Mono 10-bit	Bayer 8-Bit Bayer 10-Bit	RGBA 32-bit RGB 24-bit Yuv422 16-bit Mono 8-bit
Trigger to Exposure Minimum delay (<i>Synchronous Exposure Alignment</i>)	4 μ s if exposureAlignment = Synchronous With No Overlap between the new exposure and the previous readout 26.2 μ s if exposureAlignment = Synchronous With Overlap between the new exposure and the previous readout		
Trigger to Exposure Minimum delay (<i>Reset Exposure Alignment</i>)	4 μ s		
Trigger to Exposure Start jitter (best case with <i>Synchronous Exposure Alignment</i>)	Up to 1 line time		
Trigger to Exposure Start jitter (<i>Reset Exposure Alignment</i>) *	0 μ s		
Exposure Time Minimum (see "exposureTimeActual" in Sensor Control)	34 μ s (increment steps of 1 μ s)		
Min. Time from End of Exposure to Start of Next Exposure	19 μ s – Normal Readout 18 μ s – Fast Readout		
Horizontal Line Time:	3.86 μ s – Normal Readout 2.83 μ s – Fast Readout		
Readout Time	2332 μ s – Normal Readout for 800 x 600 Add 75 μ s when overlapping Exposure and Readout 1713 μ s – Fast Readout for 800 x 600 Add 62 μ s when overlapping Exposure and Readout <i>Specifically: (Horizontal line time at current resolution * number of lines) + (3 * (line time of the 1280 model))</i>		
Auto-Brightness	Yes , with Auto-Exposure and AGC (FPGA Gain)		
Black offset control	Yes (in DN)		
Gain Control	In-sensor Analog Gain (1.0x to 8x) in 11 gain steps (1.0, 1.14, 1.33, 1.6, 2.0, 2.29, 2.67, 3.2, 4.0, 5.33, 8.0) In-sensor Digital Gain (1x to 32x) in 0.01x steps In-FPGA Digital Gain (1x to 4x) in 0.007x steps		
Binning Support	Yes In-FPGA (summing and average, 2x2, 4x4) Yes In- Sensor (averaging 2x2)	No	
Color Correction Support	No		Yes
Decimation Support	No		
Defective Pixel Replacement	Yes, up to 512 positions		
Image Correction	Yes, Sensor FPN correction feature		
Image Flip Support	Yes, In-Sensor, Vertical Only		
Multi-ROI Support	Yes, in Sensor, up to 16 ROI (mutually exclusive with binning)		
On-Board Image Memory	90MB		
Output Dynamic Range (dB)	62.1 dB (in 10-Bit Pixel Format)		
SNR (dB)	38.8 dB (in 10-Bit Pixel Format)		

* Note: The actual internal minimum exposure may be different than what is programmed. Use the feature "exposureTimeActual" from the [Sensor Control](#) category to read back the actual sensor exposure. The exposure start sensor event is delayed 4 μ s from the actual start.

Firmware Files for Models 640, 800

The latest firmware files for all Nano models are available on the Teledyne DALSA support web site: <http://www.teledynedalsa.com/imaging/support/downloads/firmware/>. The firmware files for these models are listed below. The xx denotes the current build number.

M640, M800

- Standard
"Genie_Nano_OnSemi_Python_0.3M-0.5M-1.3M-2M-5M_Mono_STD_Firmware_5CA18.xx.cbf"

C640, C800

- Bayer Output
"Genie_Nano_OnSemi_Python_0.3M-0.5M-1.3M-2M-5M_Bayer_STD_Firmware_6CA18.xx.cbf"
- RGB Output
"Genie_Nano_OnSemi_Python_0.3M-0.5M-1.3M-2M-5M_RGB_Output_Firmware_6CA18.xx.cbf"

Specifications: M1240, C1240

Supported Features	Nano-M1240	Nano-C1240	
Resolution	1280 x 1024		
Sensor	OnSemi Python1300 P3 (1.3M)		
Pixel Size	4.8 μm x 4.8 μm		
Shutter type	Full frame electronic global shutter function		
Full Well charge	10ke (max)		
Firmware option (Field programmable)	Standard Design Monochrome	Standard Design Bayer	RGB-Output Design
Max. Internal Frame Rate Full Resolution (1280 x 1024)	87 fps (Normal Readout Enable)		
Maximum Sustained Frame Rate Output (with TurboDrive v1)	87 fps (8-bit) 87 fps (10-bit)		N/A
Maximum Sustained Frame Rate Output (without TurboDrive)	87 fps (8-bit) 45 fps (10-bit)		22 fps (RGBA) 33 fps (RGB) 45 fps (Yuv422) 87 fps (mono-8)
Pixel Data Formats	Mono 8-bit Mono 10-bit	Bayer 8-Bit Bayer 10-Bit	RGBA 32-bit RGB 24-bit Yuv422 16-bit Mono 8-bit
Trigger to Exposure Minimum delay (Synchronous Exposure Alignment)	6 μs if exposureAlignment = Synchronous With No Overlap between the new exposure and the previous readout 65 μs if exposureAlignment = Synchronous With Overlap between the new exposure and the previous readout		
Trigger to Exposure Minimum delay (Reset Exposure Alignment)	6 μs		
Trigger to Exposure Start jitter (best case with Synchronous	Up to 1 line time		

Exposure Alignment)		
Trigger to Exposure Start jitter (Reset Exposure Alignment) *	0 μ s	
Actual Exposure Time Minimum (see "exposureTimeActual" feature)*	34 μ s (increment steps of 1 μ s)	
Min. Time from End of Exposure to Start of Next Exposure (second frame)	165 μ s – Normal Readout	
Horizontal Line Time:	11.07 μ s – Normal Readout	
Readout Time	11351 μ s – Normal Readout for 1280 x 1024 Add 150 μ s when overlapping Exposure and Readout Detailed formula : (Horizontal line time at current resolution * number of lines) + (3 * (line time of the 1280 model))	
Auto-Brightness	Yes , with Auto-Exposure and AGC (FPGA Gain)	
Black offset control	Yes (in DN)	
Gain Control	In-sensor Analog Gain (1.0x to 8x) in 11 gain step (1.0, 1.14, 1.33, 1.6, 2.0, 2.29, 2.67, 3.2, 4.0, 5.33, 8.0) In-sensor Digital Gain (1x to 32x) in 0.01x step In-FPGA Digital Gain (1x to 4x) in 0.007x step	
Binning Support	Yes In-FPGA (summing and average, 2x2, 4x4) Yes In- Sensor (averaging 2x2)	No
Color Correction Support	No	Yes
Decimation Support	No	
Defective Pixel Replacement	Yes, up to 512 positions	
Image Correction	Yes, Sensor FPN correction feature	
Image Flip Support	Yes In-Sensor – Vertical Only	
Multi-ROI Support	Yes in Sensor, up to 16 ROI (mutually exclusive with binning)	
On-Board Image Memory	90MB	
Output Dynamic Range (dB)	61.8 dB (in 10-Bit Pixel Format)	
SNR (dB)	39.7 dB (in 10-Bit Pixel Format)	

* **Note:** The actual internal minimum exposure may be different than what is programmed. Use the feature "exposureTimeActual" from the [Sensor Control](#) category to read back the actual sensor exposure. The exposure start sensor event is delayed 4 μ s from the actual start.

Firmware Files for Models 1240

M1240

- Standard
Genie_Nano_OnSemi_Python_P3_1.3M_Mono_STD_Firmware_12CA18.x.cbf

C1240

- Standard
Genie_Nano_OnSemi_Python_P3_1.3M_Bayer_STD_Firmware_13CA18.x.cbf

Specifications: M1280, M1280-NIR, C1280

Supported Features	M1280, M1280-NIR		C1280
Resolution	1280 x 1024		
Sensor	OnSemi Python1300 P1 (1.3M)		
Pixel Size	4.8 μm x 4.8 μm		
Shutter type	Full frame electronic global shutter function		
Full Well charge	10ke (max)		
Firmware option (Field programmable)	Standard Design Monochrome	Standard Design Bayer	RGB-Output Design
Max. Internal Frame Rate Full Resolution (1280 x 1024)	213 fps (Fast Readout Enable) 174 fps (Normal Readout Enable)		
Maximum Sustained Frame Rate Output (with TurboDrive v1)	184 fps (8-bit) 92 fps (10-bit)		N/A
Maximum Sustained Frame Rate Output (without TurboDrive)	88 fps (8-bit) 44 fps (10-bit)		22 fps (RGBA) 33 fps (RGB) 44 fps (Yuv422) 88 fps (8-bit mono)
Pixel Data Formats	Mono 8-bit Mono 10-bit	Bayer 8-Bit Bayer 10-Bit	RGBA 32-bit RGB 24-bit Yuv422 16-bit Mono 8-bit
Trigger to Exposure Minimum delay (Synchronous Exposure Alignment)	4 μs if exposureAlignment = Synchronous With No Overlap between the new exposure and the previous readout 26.2 μs if exposureAlignment = Synchronous With Overlap between the new exposure and the previous readout		
Trigger to Exposure Minimum delay (Reset Exposure Alignment)	4 μs		
Trigger to Exposure Start jitter (best case with Synchronous Exposure Alignment)	Up to 1 line time		
Trigger to Exposure Start jitter (Reset Exposure Alignment) *	0 μs		
Exposure Time Minimum (see "exposureTimeActual" in Sensor Control)	34 μs (increment steps of 1 μs)		
Min. Time from End of Exposure to Start of Next Exposure (second frame)	19 μs – Normal Readout 18 μs – Fast Readout		
Horizontal Line Time:	5.53 μs – Normal Readout 4.5 μs – Fast Readout		
Readout Time	5676 μs – Normal Readout for 1280 x 1024 Add 75 μs when overlapping Exposure and Readout 4621 μs – Fast Readout for 1280 x 1024 Add 62 μs when overlapping Exposure and Readout <i>Specifically: (Horizontal line time at current resolution * number of lines) + (3 * (line time of the 1280 model))</i>		
Auto-Brightness	Yes , with Auto-Exposure and AGC (FPGA Gain)		
Black offset control	Yes (in DN)		

Gain Control	In-sensor Analog Gain (1.0x to 8x) in 11 gain steps (1.0, 1.14, 1.33, 1.6, 2.0, 2.29, 2.67, 3.2, 4.0, 5.33, 8.0) In-sensor Digital Gain (1x to 32x) in 0.01x steps In-FPGA Digital Gain (1x to 4x) in 0.007x steps		
Binning Support	Yes In-FPGA (summing and average, 2x2, 4x4) Yes In- Sensor (averaging 2x2)	No	
Color Correction Support	No		Yes
Decimation Support	No		
Defective Pixel Replacement	Yes, up to 512 positions		
Image Correction	Yes, Sensor FPN correction feature		
Image Flip Support	Yes, In-Sensor, Vertical Only		
Multi-ROI Support	Yes, in Sensor, up to 16 ROI (mutually exclusive with binning)		
On-Board Image Memory	90MB		
Output Dynamic Range (dB)	61.8 dB (in 10-Bit Pixel Format)		
SNR (dB)	39.7 dB (in 10-Bit Pixel Format)		

* Note: The actual internal minimum exposure may be different than what is programmed. Use the feature "exposureTimeActual" from the [Sensor Control](#) category to read back the actual sensor exposure. The exposure start sensor event is delayed 4 μ s from the actual start.

Specifications: M1930, M1930-NIR, C1930

Supported Features	M1930, M1930-NIR	Nano-C1930	
Resolution	1984 x 1264		
Sensor	OnSemi Python2000 P1 (2.3M)		
Pixel Size	4.8 μ m x 4.8 μ m		
Shutter type	Full frame electronic global shutter function		
Full Well charge	10ke (max)		
Firmware option (Field programmable)	Standard Design Monochrome	Standard Design Bayer	RGB-Output Design
Max. Internal Frame Rate Full Resolution (1984 x 1264)	107 fps (Fast Readout Enable) 84.5 fps (Normal Readout Enable)		
Maximum Sustained Frame Rate Output (with TurboDrive v1)	107 fps (8-bit) 52 fps (10-bit)		N/A
Maximum Sustained Frame Rate Output (without TurboDrive)	46 fps (8-bit) 23 fps (10-bit)		12 fps (RGBA) 16 fps (RGB) 23 fps (Yuv422) 46 fps (8-bit mono)
Pixel Data Formats	Mono 8-bit Mono 10-bit	Bayer 8-Bit Bayer 10-Bit	RGBA 32-bit RGB 24-bit Yuv422 16-bit Mono 8-bit

Trigger to Exposure Minimum delay (<i>Synchronous Exposure Alignment</i>)	8 μ s if exposureAlignment = Synchronous With No Overlap between the new exposure and the previous readout 26.2 μ s if exposureAlignment = Synchronous With Overlap between the new exposure and the previous readout	
Trigger to Exposure Minimum delay (<i>Reset Exposure Alignment</i>)	3 μ s	
Trigger to Exposure Start jitter (best case with <i>Synchronous Exposure Alignment</i>)	Up to 1 line time	
Trigger to Exposure Start jitter (<i>Reset Exposure Alignment</i>) *	0 μ s	
Exposure Time Minimum (see "exposureTimeActual" in Sensor Control)	87 μ s (increment steps of 1 μ s)	
Min. Time from End of Exposure to Start of Next Exposure (second frame)	49 μ s – Normal Readout 47 μ s – Fast Readout	
Horizontal Line Time:	9 μ s – Normal Readout 7 μ s – Fast Readout	
Readout Time	10831 μ s – Normal Readout for 1920 x 1200 Add 76 μ s when overlapping Exposure and Readout 8428 μ s μ s – Fast Readout for 1920 x 1200 Add 64 μ s when overlapping Exposure and Readout <i>Specifically: (Horizontal line time at current resolution * number of lines) + (3 * (line time of the 2590 model))</i>	
Auto-Brightness	Yes , with Auto-Exposure and AGC (FPGA Gain)	
Black offset control	Yes (in DN)	
Gain Control	In-sensor Analog Gain (1.0x to 8x) in 11 gain steps (1.0, 1.14, 1.33, 1.6, 2.0, 2.29, 2.67, 3.2, 4.0, 5.33, 8.0) In-sensor Digital Gain (1x to 32x) in 0.01x steps In-FPGA Digital Gain (1x to 4x) in 0.007x steps	
Binning Support	Yes In-FPGA (summing and average, 2x2, 4x4) Yes In- Sensor (averaging 2x2)	No
Color Correction Support	No	Yes
Decimation Support	No	
Defective Pixel Replacement	Yes, up to 512 positions	
Image Correction	No	
Image Flip Support	Yes, In-Sensor, Vertical Only	
Multi-ROI Support	Yes, in Sensor, up to 16 ROI (mutually exclusive with binning)	
On-Board Image Memory	90MB	
Output Dynamic Range (dB)	62.1 dB (in 10-Bit Pixel Format)	
SNR (dB)	39.8 dB (in 10-Bit Pixel Format)	

* Note: The actual internal minimum exposure may be different than what is programmed. Use the feature "exposureTimeActual" from the [Sensor Control](#) category to read back the actual sensor exposure. The exposure start sensor event is delayed 4 μ s from the actual start.

Specifications: M2590, M2590-NIR, C2590

Supported Features	M2590, M2590-NIR		Nano-C2590	
Resolution	2592 x 2048			
Sensor	OnSemi Python5000 P1 (5.1M)			
Pixel Size	4.8 μm x 4.8 μm			
Shutter type	Full frame electronic global shutter function			
Full Well charge	10ke (max)			
Firmware option (Field programmable)	Standard Design Monochrome	Standard Design Bayer	RGB-Output Design	
Max. Internal Frame Rate Full Resolution (2592 x 2048)	51.8 fps (Fast Readout Enable) 24.7 fps (Normal Readout Enable)			
Maximum Sustained Frame Rate Output (with TurboDrive v1)	42.7 fps (8-bit) 24.9 fps (10-bit)		N/A	
Maximum Sustained Frame Rate Output (without TurboDrive)	22 fps (8-bit)		5.5 fps (RGBA) 8.7 fps (RGB) 11 fps (Yuv422) 22 fps (8-bit mono)	
Pixel Data Formats	Mono 8-bit Mono 10-bit	Bayer 8-Bit Bayer 10-Bit	RGBA 32-bit RGB 24-bit Yuv422 16-bit Mono 8-bit	
Trigger to Exposure Minimum delay (Synchronous Exposure Alignment)	8 μs if exposureAlignment = Synchronous With No Overlap between the new exposure and the previous readout 26.2 μs if exposureAlignment = Synchronous With Overlap between the new exposure and the previous readout			
Trigger to Exposure Minimum delay (Reset Exposure Alignment)	3 μs			
Trigger to Exposure Start jitter (best case with Synchronous Exposure Alignment)	Up to 1 line time			
Trigger to Exposure Start jitter (Reset Exposure Alignment) *	0 μs			
Exposure Time Minimum (see "exposureTimeActual" in Sensor Control)	87 μs (increment steps of 1μs)			
Min. Time from End of Exposure to Start of Next Exposure (second frame)	49 μs – Normal Readout 47 μs – Fast Readout			
Horizontal Line Time:	11.33 μs – Normal Readout 9.33 μs – Fast Readout			
Readout Time	23242 μs – Normal Readout for 2592 x 2048 Add 76μs when overlapping Exposure and Readout 19142 μs – Fast Readout for 2592 x 2048 Add 64μs when overlapping Exposure and Readout <i>Specifically: (Horizontal line time at current resolution * number of lines) + (3 * (line time of the 2590 model))</i>			
Auto-Brightness	Yes , with Auto-Exposure and AGC (FPGA Gain)			
Black offset control	Yes (in DN)			

Gain Control	In-sensor Analog Gain (1.0x to 8x) in 11 gain steps (1.0, 1.14, 1.33, 1.6, 2.0, 2.29, 2.67, 3.2, 4.0, 5.33, 8.0) In-sensor Digital Gain (1x to 32x) in 0.01x steps In-FPGA Digital Gain (1x to 4x) in 0.007x steps	
Binning Support	Yes In-FPGA (summing and average, 2x2, 4x4) Yes In- Sensor (averaging 2x2)	No
Color Correction Support	No	Yes
Decimation Support	No	
Defective Pixel Replacement	Yes, up to 512 positions	
Image Correction	No	
Image Flip Support	Yes, In-Sensor, Vertical Only	
Multi-ROI Support	Yes, in Sensor, up to 16 ROI (mutually exclusive with binning)	
On-Board Image Memory	90MB	
Output Dynamic Range (dB)	62.1 dB (in 10-Bit Pixel Format)	
SNR (dB)	39.8 dB (in 10-Bit Pixel Format)	

* Note: The actual internal minimum exposure may be different than what is programmed. Use the feature "exposureTimeActual" from the [Sensor Control](#) category to read back the actual sensor exposure. The exposure start sensor event is delayed 4 μ s from the actual start.

Firmware Files for Models 1280, 1930, 2590

The latest firmware files for all Nano models are available on the Teledyne DALSA support web site: <http://www.teledynedalsa.com/imaging/support/downloads/firmware/>

The firmware files for these models are listed below. The xx denotes the current build number.



M1280, M1930, M2590

- Standard
"Genie_Nano_OnSemi_Python_0.3M-0.5M-1.3M-2M-5M_Mono_STD_Firmware_5CA18.xx.cbf"

C1280, C1930, C2590

- Bayer Output
"Genie_Nano_OnSemi_Python_0.3M-0.5M-1.3M-2M-5M_Bayer_STD_Firmware_6CA18.xx.cbf"
- RGB Output
"Genie_Nano_OnSemi_Python_0.3M-0.5M-1.3M-2M-5M_RGB_Output_Firmware_6CA18.xx.cbf"

NanoXL Specifications: M5100, M5100-NIR, C5100, M4090, M4090-NIR, C4090

Supported Features	M5100, M5100-NIR & C5100		M4090, M4090-NIR & C4090	
Resolution	5120 x 5120		4096 x 4096	
Sensor	On-Semi Python25K (25M)		On-Semi Python16K (16M)	
Pixel Size	4.5 µm x 4.5 µm			
Shutter Type	Full frame electronic global shutter function			
Full Well charge	12ke (max)			
Firmware options (field programmable)	Standard Design (Mono & Bayer)	High Speed Design (Mono & Bayer)	Standard Design (Mono & Bayer)	High Speed Design (Mono & Bayer)
Max. Internal Frame Rate	10.2 fps	20.1 fps	15.6 fps	31.2 fps
Maximum Sustained Frame Rate Output (with TurboDrive) **	9.5 fps (8-bit) 4.7 fps (10-bit)	9.5 fps (8-bit)	15.6 fps (8-bit) 7.9 fps (10-bit)	15.6 fps (8-bit)
Maximum Sustained Frame Rate Output (without TurboDrive)	4.5 fps (8-bit) 2.75 fps (10-bit)	4.5 fps (8-bit)	7.1 fps (8-bit) 3.5 fps (10-bit)	7.1 fps (8-bit)
Pixel Format (Mono) 	Mono 8 & 10 bit	Mono 8 bit	Mono 8 & 10 bit	Mono 8 bit
Pixel Format (Color) 	Bayer 8 & 10 bit	Bayer 8 bit	Bayer 8 & 10 bit	Bayer 8 bit
Trigger to Exposure Minimum delay (Synchronous Exposure)	4 µs			
Trigger to Exposure Minimum delay (Reset Exposure)	4 µs			
Trigger to Exposure Start jitter (Synchronous Exposure)	Up to 1 line time			
Trigger to Exposure Start jitter (Reset Exposure)	0 µs			
Exposure Time Minimum (see "exposureTimeActual" in Sensor Control)	34 µs			
Horizontal Line Time: Normal Mode $\ddagger\ddagger$	33.1 µs	16.55 µs	29.55 µs	14.78 µs
Horizontal Line Time: Fast Readout $\ddagger\ddagger$	19.1 µs	9.56 µs	15.55 µs	7.78 µs
Min. Time from End of Exposure to Start of Next Exposure	Normal Readout: 120 us Fast Readout: 92 us	Normal Readout: 79 us Fast Readout: 65 us	Normal Readout: 120 us Fast Readout: 92 us	Normal Readout: 79 us Fast Readout: 65 us
Readout Time	(Horizontal Line Time * NB Lines) + (2 * Horizontal Line Time at Maximum Sensor Width), in µs			
Auto-Brightness	Yes , with Auto-Exposure and AGC (FPGA Gain)			
Black offset control	Yes (in DN)			
Gain Control	In-sensor Analog Gain (1.0x to 3.17x) in 4 steps (1.0x, 1.26x, 2.87x, 3.17x) In-sensor Digital Gain (1x to 32x) in 0.01x steps In-FPGA Digital Gain (1x to 4x) in 0.007x steps			
Binning Support	Monochrome models only — In-FPGA (summing and average, 2x2, 4x4)			
Color Correction Support	No			
Decimation Support	No			

Defective Pixel Replacement	Yes , up to 2048 pixel positions			
Image Correction	Flat Line Correction (Factory and 4 User Defined entries)			
Image Flip support	Yes, vertical only (in-sensor)			
Multi-ROI Support	Yes, (in-sensor) up to 16 ROI			
On-board Image memory	500MB			
Output Dynamic Range (dB)	55.3	55.3	55.3	55.3
SNR (dB)	39.4	39.6	39.4	39.6

**** Limited to the Genie Nano Architecture:**

~250MB/sec Sustained into the TurboDrive Engine achieved using 1500 Byte Packet Size

‡‡ Horizontal Line Time: Table Values and Formulas

Values stated in the table are calculated for the maximum sensor widths, specifically:

- Model M5100=5120 pixels
- Model M4090=4096 pixels

The following formulas describe **Horizontal Line Time**. Note that in “Fast Readout” mode, the line time does not reduce for widths below 4032 pixels, thus no need to calculate applicable time values for shorter lines.

- Horizontal line time (Standard Firmware, Normal mode) = $\frac{\left(\frac{width}{4}\right) + 1104}{72}$
- Horizontal line time** (Standard Firmware, Fast Readout mode) = $\frac{\left(\frac{width}{4}\right) + 96}{72}$
- Horizontal line time (High Speed Firmware, Normal mode) = $\frac{\left(\frac{width}{8}\right) + 552}{72}$
- Horizontal line time** (High Speed Firmware, Fast Readout mode) = $\frac{\left(\frac{width}{8}\right) + 48}{72}$

Spectral Response

Model specific specifications and response graphics for the On-Semi Python (25K & 16K) series are provided here. The response curves describe the sensor, excluding lens and light source characteristics.

On-Semi Python Series (P1 & P3) — Monochrome and NIR

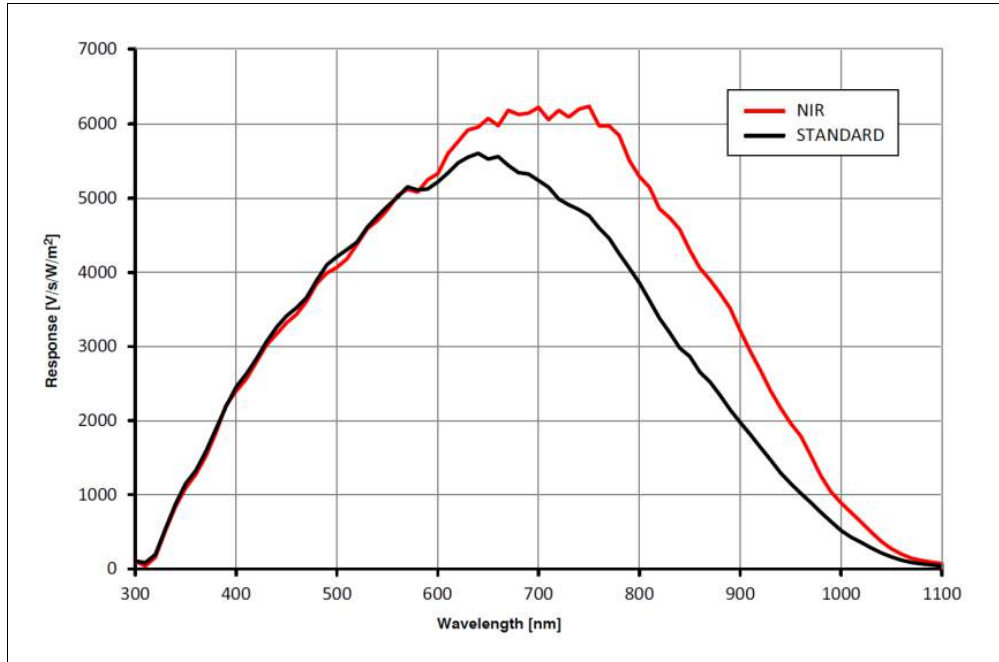

On-Semi Python Series (P1 & P3) — Bayer Color

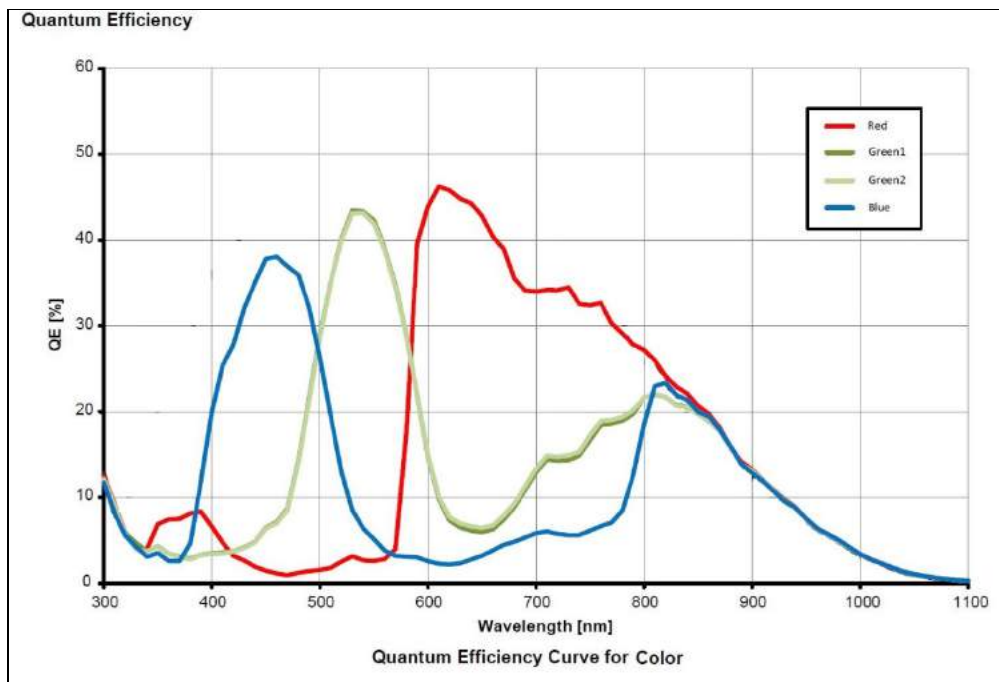

Defective Pixel Specification for Models 5100/4090

These defective pixel specifications in the following table are as published by the sensor manufacturer. Genie Nano cameras apply defective pixel corrections to improve the camera performance.

Defective Pixels (max: 1000)	Number of defective pixels allowed in the full window size of 5120 x 5120 (i.e. model 5100).
	For mono devices: A defective pixel is defined as a pixel which has a response that deviates 102 LSB10 in a dark image or a corrected gray image, or a saturated image, from the local median of the neighboring pixels in a 7 x 7 block.
	For color devices: The pixels are divided per color channels (R, G1, G2, B) and then calculated with the same methodology as mono devices.
	The defective pixels in dark, gray and saturated images are stored a in a global defect map. The limit is applied to the global defect map.
Defective Column 0 defective columns allowed	Number of defective columns in the full window size of 5120 x 5120 derived from dark, half scale and saturated image.
	For Mono devices: A bad column is defined as a column which has a response that deviates 48 LSB10 in a dark image, or a corrected gray or a saturated image, from the local median of 11 neighboring columns (+/- 5 left/right columns).
	For Color devices: The pixels are divided per color channels (R, G1, G2, B) and then calculated with the same methodology as mono devices.
Defective Row 0 defective rows allowed	Number of defective rows in the full window size of 5120 x 5120 derived from dark, half scale and saturated image.
	For Mono devices: A bad row is defined as a row which has a response that deviates 48 LSB10 in a dark image, or a corrected gray or a saturated image, from the local median of 11 neighboring rows (+/- 5 top/bottom rows).
	For Color devices: The pixels are divided per color channels (R, G1, G2, B) and then calculated with the same methodology as mono devices.
<i>continued next page</i>	

Defective Cluster Definition

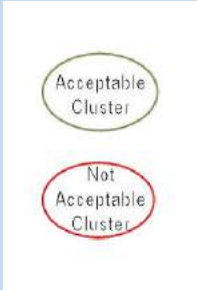

Number of clusters allowed in the full window size of 5120 X 5120. A cluster is defined as a group of neighboring defective pixels (top, Bottom side, not diagonal), derived from the global defect map.

For color devices: The pixels are divided per color channels (R, G1, G2, B) and then calculated with the same methodology as mono devices.

Refer to the graphic below:

The number of defective pixels in one cluster is the class (F) of the cluster:

F2 (max 5): 2 defective pixels in the cluster

F3 (max 4): 3 defective pixels in the cluster

F4 (max 3): 4 defective pixels in the cluster

F5 (max 0): 5 or more defective pixels in the cluster

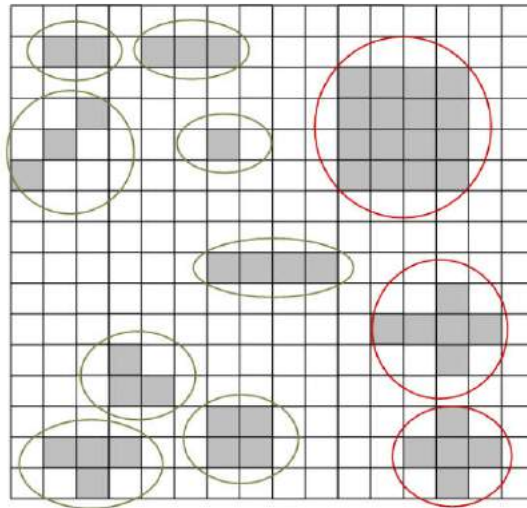

Firmware Files for Models 5100/4090

The latest firmware files for all Nano models are available on the Teledyne DALSA support web site: <http://www.teledynedalsa.com/imaging/support/downloads/firmware/>

The firmware files for these models are listed below. The xx denotes the current build number.

M4090 & M5100

- Standard
"Genie_Nano_OnSemi_Python_16M-25M_Mono_STD_Firmware_CCA18.xx.cbf"
- High Speed
"Genie_Nano_OnSemi_Python_16M-25M_Mono_HS_Firmware_CCA18.xx.cbf"

C4090 & C5100

- Bayer Output
"Genie_Nano_OnSemi_Python_16M-25M_Bayer_STD_Firmware_DCA18.xx.cbf"
- High Speed Bayer Output
"Genie_Nano_OnSemi_Python_16M-25M_Bayer_HS_Firmware_DCA18.xx.cbf"

Specifications: C4900

Model specific specifications and response graphics for the On-Semi AR1820HS sensor are provided here. The response curves exclude lens and light source characteristics.

Supported Features	C4900			
Full Active Resolution	4912 x 3684			
Sensor	On-Semi AR1820HS (18M)			
Pixel Size	1.25 μm x 1.25 μm			
Shutter Type	Electronic Rolling Shutter function (ERS) with Global Reset Release (GRR) function			
Full Well charge	4.3ke (max)			
Firmware Options (field programmable)	Standard Bayer Output Design		RGB Output Design (includes monochrome output)	
Max. Internal Frame Rate	13.3 fps	at 4912 x 3684 resolution		
	42.2 fps	at 2556 x 1842 resolution (Decimation 2x2)		
	116.8 fps	at 1228 x 920 resolution (Decimation 4x4)		
Maximum Sustained Frame Rate Output <i>Full Resolution with TurboDrive v1</i>	13 fps		N/A	
Maximum Sustained Frame Rate Output <i>Full Resolution without TurboDrive</i>	5.88 fps	Bayer 8-bit	5.88 fps	Monochrome 8-bit
	2.9 fps	Bayer 12-bit	2.9 fps	YUV422
			1.96 fps	RGB 24-bit
			1.47 fps	RGBA 32-bit
Pixel Data Formats	Bayer 8-Bit Bayer 12-Bit		Monochrome 8-bit YUV422 16-bit RGB 24-bit RGBA 32-bit (RGB 24 & Mono 8)	
Trigger to Exposure Minimum delay (Synchronous Exposure Alignment)	Not Supported			
Trigger to Exposure Minimum delay (Reset Exposure Alignment)	790 μs (ERS mode) / 450 μs (GRR mode)			
Trigger to Exposure Start jitter (best case with Synchronous Exposure Alignment)	Not Supported			
Trigger to Exposure Start jitter (Reset Exposure Alignment)	0 μs (ERS mode) / 20 μs (GRR mode)			
Actual Exposure Time Minimum (see "exposureTimeActual" in Sensor Control)	118 μs (ERS mode) / 836 μs (GRR mode) – Full Resolution 73 μs (ERS mode) / 483 μs (GRR mode) – (Decimation 2x2) 51 μs (ERS mode) / 318 μs (GRR mode) – (Decimation 4x4)			
Exposure Time Maximum	0.5 seconds			
Minimum Time from End of Exposure to Start of Next Exposure (second frame)	74.76 ms (ERS mode) / 75.09 ms (GRR mode) – Full Resolution 23.5 ms (ERS mode) / 23.9 ms (GRR mode) – (Decimation 2x2) 8.87 ms (ERS mode) / 8.43 ms (GRR mode) – (Decimation 4x4)			
Horizontal Line Time	20 μs			
Readout Time	(Horizontal Line readout) x (lines in frame) — in μs			
Auto Brightness	No			
Black Offset control	Yes (in DN)			
Gain Control	In-sensor Analog Gain (1.0x to 8x) in 0.01x steps In-FPGA Digital Gain (1x to 4x) in 0.007x steps			
Binning Support	No			

Color Correction Support	No
Decimation Support	Yes, 2x2 and 4x4
Defective Pixel Replacement	No
Image Correction	No
Image Flip Support	Yes, in-sensor, both vertical and horizontal
Multi-ROI Support	No
On-board image memory	220MB
Dynamic Range	76.4 dB
Sensor SNR	39.6 dB
Responsivity	see following graphic

Spectral Response

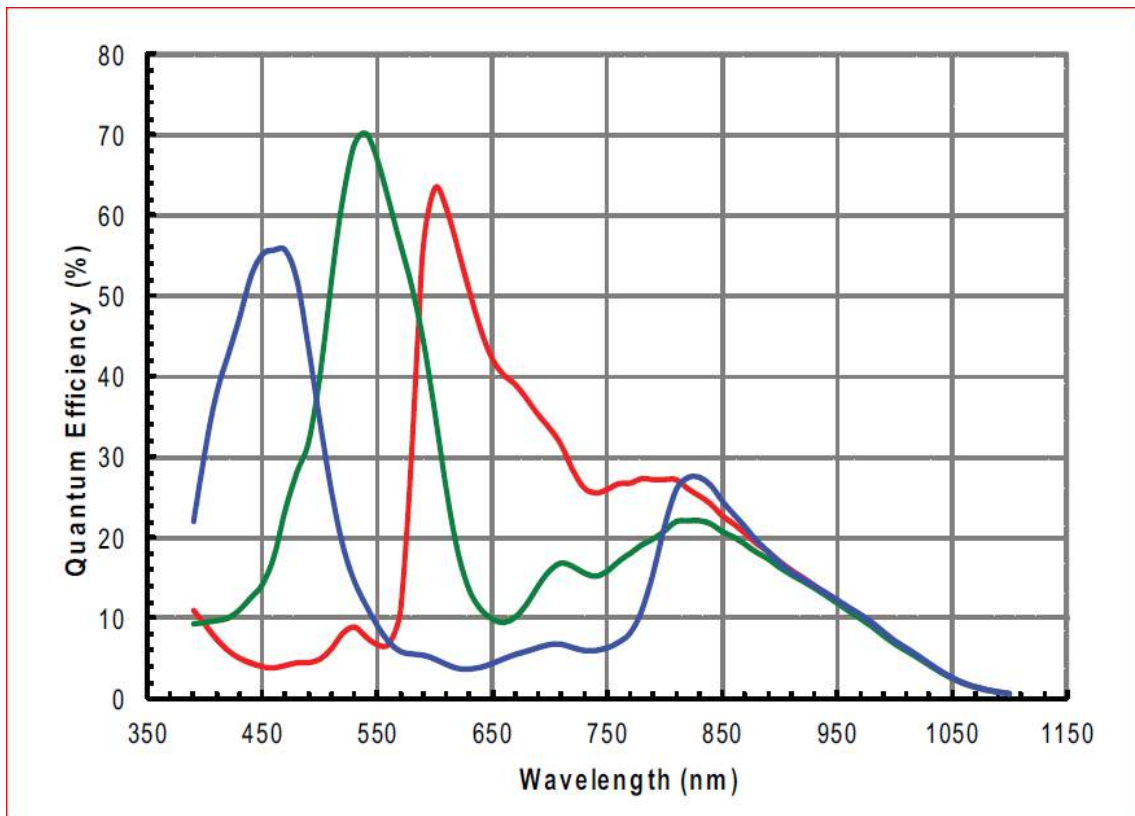

Supplemental Usage Notes:

Reduced Operating Temperature: The model C4900 has a reduced maximum temperature specification (-20°C to +50°C / -4°F to +122°F) as specified in section [Genie Nano Common Specifications](#). This temperature specification is measured at the front plate. If the camera temperature is exceeded, the camera's acquisition or any other camera operation may lock up. Simply cool and reset the camera to resume normal operation.

Exposer Time Locked during Acquisition: Unlike other Nano models, the Nano C4900 does not allow exposure time changes during an active acquisition. Freeze the acquisition first, then make an exposure time change.

Model C4900 Sensor Cosmetic Specifications

Due to the significant engineering design differences of the Rolling Shutter – High Pixel Density sensor used in the model C4900, its cosmetic specifications are not consistent with the other Nano models. The following table applies only to the Nano model C4900 (AR1820HS sensor).

Blemish Specification	Maximum Number of Defects	Blemish Description & Test Condition (LSB values refer to 10-bit output)
Very Hot Pixel Defect	600	Defined as any single pixel greater than 500 LSBs above the mean value of the array, with the sensor operated under no illumination. (Analog gain = 8x; exposure time = 200ms)
Hot Pixel Defect	1500	Defined as any single pixel greater than 300 LSBs above the mean value of the array, with the sensor operated under no illumination. (Analog gain = 8x; exposure time = 200ms)
Very Bright Pixel Defect	600	Sensor illuminated to midlevel (450 LSBs to 650 LSBs). Within a color plane, each pixel is compared to the mean of the neighboring 11 x 11 pixels. A pixel value 50 percent or more above the mean is considered a very bright pixel defect. (Analog gain = 1x; exposure time = 12.5ms)
Bright Pixel Defect	1500	Sensor illuminated to midlevel (450 LSBs to 650 LSBs). Within a color plane, each pixel is compared to the mean of the neighboring 11 x 11 pixels. A pixel value 25 percent or more above the mean is considered a bright pixel defect. (Analog gain = 1x; exposure time = 12.5ms)
Very Dark Pixel Defect	600	Sensor illuminated to midlevel (450 LSBs to 650 LSBs). Within a color plane, each pixel is compared to the mean of the neighboring 11 x 11 pixels. A pixel value 50 percent or more below the mean is considered a very dark pixel defect. (Analog gain = 1x; exposure time = 12.5ms)
Dark Pixel Defect	600	Sensor illuminated to midlevel (450 LSBs to 650 LSBs). Within a color plane, each pixel is compared to the mean of the neighboring 11 x 11 pixels. A pixel value 25 percent or more below the mean is considered a dark pixel defect. (Analog gain = 1x; exposure time = 12.5ms)

Model C4900 – On-Semi AR1820HS sensor Limitations:

- Under conditions combining high sensor temperatures and illumination exceeding (by a factor of 5 or more) what is required to saturate sensor pixels, the sensor will produce column noise which is seen as columns of dark pixels in areas where they should be saturated white. For an example see [Model C4900 Column Noise in Saturated Areas](#).
- This sensor is susceptible to the black sun effect (over-saturated pixels that revert to black data) when the strobe lighting extends longer than the exposure period.

Firmware Files for This Model

The latest firmware files for all Nano models are available on the Teledyne DALSA support web site: <http://www.teledynedalsa.com/imaging/support/downloads/firmware/>. The firmware files for this model are listed below. The xx denotes the current build number.

C4900

- Bayer Output
"Genie_Nano_OnSemi_AR1820HS-18M_Bayer_STD_Firmware_BCA18.xx.cbf"
- RGB Output
"Genie_Nano_OnSemi_AR1820HS-18M_RGB_Output_Firmware_BCA18.xx.cbf"

Guide to Using a Rolling Shutter Camera

The Genie Nano C4900 implements the On-Semi AR1820HS rolling shutter sensor to achieve a high pixel density – low cost solution for a number of imaging implementations. These sensors have different usage characteristics and thus provide different application solutions compared to the Nano global shutter models. The following points highlight those differences:

Simpler Sensor Design Attributes

- Rolling shutter cameras have a simpler design with smaller pixels, allowing higher resolutions for a given sensor physical area. As an example mobile phones use rolling shutter sensors.
- Depending on the imaging requirements, the higher density pixel array may require a higher quality lens. Lens specifications define the Resolution and Contrast/Modulation attributes which must be considered. This commonly used gauge is the Modulation Transfer Function (MTF) which is extensively covered by lens suppliers to qualify their products. Consider reading <https://www.edmundoptics.com/resources/application-notes/optics/introduction-to-modulation-transfer-function/> as an initial start to understanding MTF.
- A rolling shutter sensor exposes, samples, and reads out sequentially, as part of the design criteria to achieve a higher pixel density via simplified circuitry.
- Rolling shutter sensors generate less heat which translates to a lower noise level (SNR).
- Global shutter CMOS sensors require a more complicated circuit architecture, thus limiting the pixel density for a given physical size.

Rolling Shutter Trade-offs

When selecting a rolling shutter camera, the user needs to understand that the camera is not suitable for all machine vision applications. Limitations are such as:

- A rolling shutter camera is unsuitable for applications like barcode scanning, machine vision, or automated inspection systems, which require the imaging of rapidly moving objects.
- Moving objects are subject to temporal distortions best described as positional errors (shifts) from the top of an object to its bottom, due to how individual lines are exposed (detailed below).
- Rolling shutter cameras using Global Reset Release mode (GRR) are not suitable for moving objects in well-lit environments.
- Degree of distortions change as exposure time is increased or decreased.
- Use of a strobe flash with a controlled duration, in a dark imaging environment, is required to eliminate positional distortions.
- The Internet has many sources and examples of the visual distortions due to Rolling Shutter sensors, mostly in reference to using cell phones and consumer cameras. The guidelines that follow will permit the successful usage of rolling shutter cameras in machine vision applications.

Guide to ERS or GRR Exposure Modes.

The following two pages provide overviews and constraints on using either the typical *Electronic Rolling Shutter (ERS) Exposures* or *Global Reset Release (GRR) Exposures* modes.

Overview of Electronic Rolling Shutter (ERS) Exposures

Referring to the following graphic:

- Each sensor line is exposed for the programmed time integration period.
- Exposures start with Line 1. The sensor design uses a shared line readout circuit. Due to this simplified circuitry, only a single line of pixel data can be readout at any given time. Therefore the line 2 exposure (integration period) is delayed by the required readout time of line 1.
- This delayed line exposure is repeated from the sensor's first line to its last sensor line.
- This sequence allows the common readout circuit to read the data from each row. This results in an exposure start time delay between the first to last row – thus the name rolling shutter.
- To avoid motion artifacts the user needs to freeze motion using flash lighting of suitable length in a dark environment. The flash is triggered at the start of the last line's exposure and stops at the end of the first line's exposure. The flash must maintain a constant light output during this period.
- To control the flash device, use the Genie Nano output signal with these feature selections: *outputLineSource=PulseOnStartofExposure*, *outputLinePulseDelay=flashZoneDelay* (delay to the start of the last line exposure), *outputLinePulseDuration=flashZoneDuration* (optimal flash zone time as shown in the graphic below).
- The two new features mentioned, *flashZoneDelay* and *flashZoneDuration*, automatically provide the optimal flash zone time values no matter the exposure duration and any vertical cropping/offset settings. The user is free to use any delay or duration as required.
- The dark environment illumination ensures minimal exposure (and thus motion artifacts) during the sensor lines integration time occurring before and after the flash period.

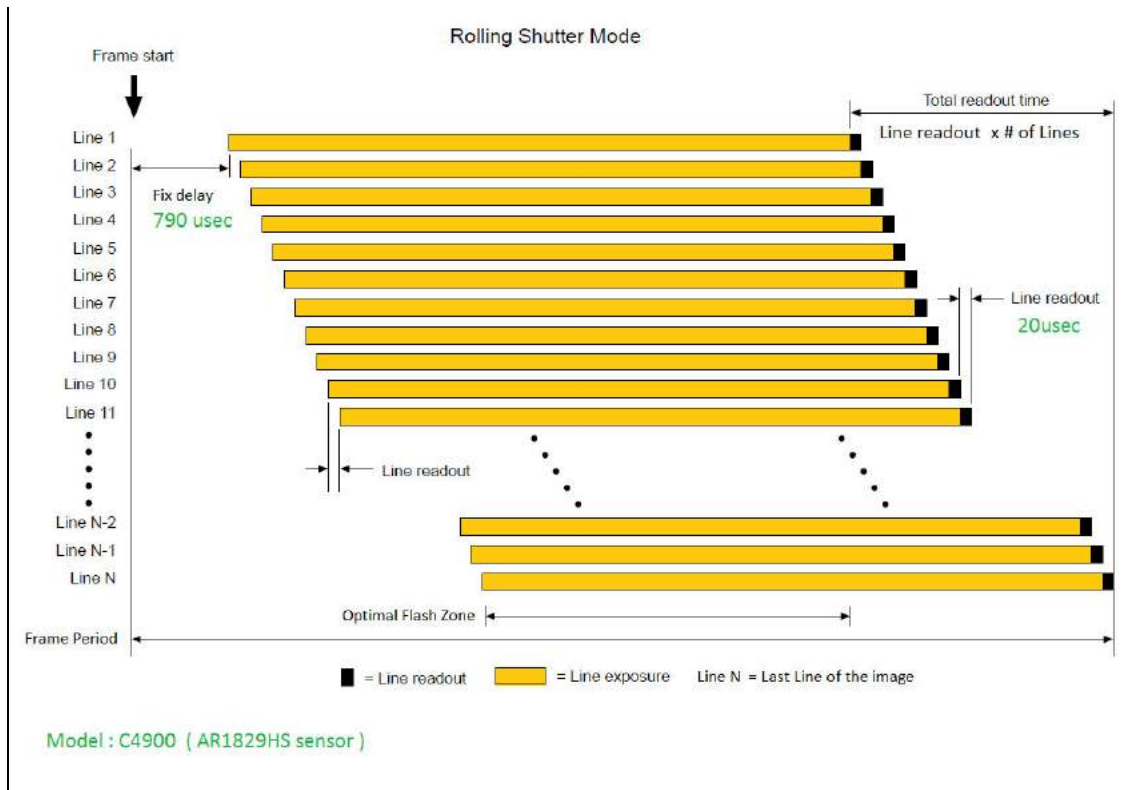

Overview of Global Reset Release (GRR) Exposures

Referring to the following graphic:

- All sensor lines start integrating at the same time, therefore GRR mode is also known as Global Start Mode.
- The first sensor line (line 1) only is exposed for the programmed time integration period.
- As mentioned previously, the sensor design uses a shared line readout circuit. Therefore again, only a single line of pixel data can be readout at any given time.
- With each sensor line starting exposure integration at once, each following line's exposure is increased by the readout time required by the previous row.
- In a well-lit environment with static objects, there is a visible exposure increase from the top sensor row to the bottom sensor row.
- And again, with moving objects in a well-lit environment, there is motion blurring from top to bottom.
- Therefore as described previously, flash lighting in a dark environment is used to freeze motion. The flash period matches the integration period for line 1. The increasing exposures for the other sensor lines will not be visible without any other illumination source.
 - Use a Genie Nano output signal for flash control as described above.



Comparison of Similar On-Semi and Sony Sensors

The following table provides an overview comparison of the Nano cameras having a similar field of view (approximately 2K horizontal) using On-Semi and Sony Sensors. Not all Nano cameras are presented so as to keep this table reasonable in size.

Parameters highlighted in green indicate specifications of interest when considering which Genie Nano camera may best match the imaging requirement. Also consider Nano cameras in other resolutions to best match your imaging system.

Model	Nano 1930 FRM † (1984 x 1264) On-Semi Python	Nano 1920 (1936 x 1216) Sony Pregius	Nano 1940 (1936 x 1216) Sony Pregius	Nano 2020 (2048 x 1536) Sony Pregius	Nano 2050 HSD ‡ (2048 x 1536) Sony Pregius
Max Acquisition Frame Rate in Native Resolution	116 fps	38 fps	83 fps	53 fps	143 fps
Acquisition Frame Rate with Region-of-Interest (ROI):	640 x 480 = 717 fps 1024 x 250 = 878 fps	640 x 480 = 94 fps 1024 x 250 = 169 fps	640 x 480 = 202 fps 1024 x 250 = 364 fps	640 x 480 = 164 fps 1024 x 248 = 301 fps	640 x 480 = 436 fps 1024 x 248 = 791 fps
Minimum Exposure	87 μs	34.23 μs	23.23 μs	25 μs	18 μs
Exposure Granularity	1 μs step	20.5 μs step	9.5 μs step	12 μs step	4.4 μs step
Trigger to Exposure Minimum delay (best case scenario **)	3 μs	2 line time (41 μs)	2 line time (19 μs)	0 μs	0 μs
Trigger to Exposure Start jitter (best case scenario**)	0 μs	Up to 1 line time 0 to 20.5 μs	Up to 1 line time 0 to 9.5 μs	0μs	0 μs
Min. Time from End of Exposure to Start of Next Exposure	47 μs	512.5 μs	237.5 μs	81 μs	30 μs
Pixel Format	8 and 10 bit	8 and 12 bit	8 and 10 bit	8 and 12 bit	8 bit
Multi-ROI capability	Yes, 16 ROIs	Yes, 16 ROIs (No FPS increase)	Yes, 16 ROIs	Yes, 16 ROIs	Yes, 16 ROIs
Moving ROI (i.e. Cycling Mode) supported in Sensor thus maximizing fps	Yes	No	No	No	No
Image Flipping	Yes Vertical only	Yes Horizontal and Vertical	Yes Horizontal and Vertical	Yes Horizontal and Vertical	Yes Horizontal and Vertical
Sensor Gain range (in the Analog domain)	1 to 8x multiplying factor	1 to 15x multiplying factor	1 to 15x multiplying factor	1 to 16x multiplying factor	1 to 16x multiplying factor

Sensor Gain range (in the Digital domain)	1 to 16x multiplying factor	1 to 15x multiplying factor (Applied after Maximum Analog gain)	1 to 15x multiplying factor (Applied after Maximum Analog gain)	1 to 16x multiplying factor (Applied after Maximum Analog gain)	1 to 16x multiplying factor (Applied after Maximum Analog gain)
Dynamic Range	62.1 dB	75.5 dB	68.3 dB	76.4 dB	56.8 dB
Signal-to-noise Ration	39.8 dB	43.9 dB	43.9 dB	39.6 dB	33.1 dB
Full Well Charge (-e)	10 ke (max)	32ke (max)	32ke (max)	11ke (max)	2.75ke (max)
Pixel Size (µm)	4.8 x 4.8	5.86 x 5.86	5.86 x 5.86	3.45 x 3.45	3.45 x 3.45

**Excluding the input Opto-coupler's propagation delay, trigger input jitter time is added to the fixed line count delay as shown by the linked graphic.

† FRM Fast Readout Mode

‡ HSD High Sensitivity Design

Nano Quick Start

If you are familiar with GigE Vision cameras, follow these steps to quickly install and acquire images with Genie Nano and Sopera LT in a Windows OS system. If you are not familiar with Teledyne DALSA GigE Vision cameras go to [Connecting the Genie Nano Camera](#).

- Your computer requires a second or unused Ethernet Gigabit network interface (NIC) that is separate from any NIC connected to any corporate or external network.
- Install Sopera 8.01 (or later) and make certain to select the installation for GigE Vision support.
- Connect the Nano to the spare NIC and wait for the [GigE Server Icon](#) in the Windows tray to show that the Nano is connected. The [Nano Status LED](#) will change to steady Blue.

Testing Nano without a Lens

- Start [CamExpert](#). The Nano Status LED will be steady Green.
- From the Image Format Feature Category, select the *Moving Grey Diagonal Ramp* test pattern from the *Test Image Selector* Parameter.
- Click grab. You will see the moving pattern in the CamExpert display window.

Testing Nano with a Lens

- Start CamExpert. The Nano Status LED will be steady Green.
- Click the [Display Control button](#) to show a full camera image on CamExpert display.
- Click grab.
- Adjust the lens aperture plus Focus, and/or adjust the Nano [Exposure Time](#) as required.

The Camera Works — Now What

Important: Before continuing, please [download the latest Nano firmware file](#) from the Teledyne DALSA web site and [install it into the Nano](#).

Consult this manual for detailed Networking and Nano feature descriptions, as you write, debug, and optimize your imaging application.

Connecting the Genie Nano Camera

GigE Network Adapter Overview

Genie Nano connects to a computer's Gigabit Network Adapter (NIC). If the computer is already connected to a network, the computer requires a second network adapter, either onboard or an additional PCIe NIC adapter. Refer to the Teledyne DALSA Network Imaging manual for information on optimizing network adapters for GigE Vision cameras.

PAUSE Frame Support

The Genie Nano supports (and monitors) the Gigabit Ethernet PAUSE Frame feature as per IEEE 802.3x. PAUSE Frame is the Ethernet flow control mechanism to manage network traffic within an Ethernet switch when multiple cameras are simultaneously used. This requires that the flow control option in the NIC property settings and the Ethernet switch settings must be enabled. The user application can monitor the Pause Frame Received Event as describe in [Event Controls](#). Refer to the Teledyne DALSA Network Imaging manual for additional information.



Note: Some Ethernet Switches may produce more Pause Frame requests than expected when Jumbo Frames is enable. Setting the Ethernet Packet Size to the default of 1500, may minimize Pause Requests from such a switch and improve overall transfer bandwidth.

Connect the Genie Nano Camera

Connecting a Genie Nano to a network system is similar whether using the Teledyne DALSA Sopera LT package or a third party GigE Vision development package.

- Power supplies must meet the requirements defined in section Input Signals Electrical . Apply power to the camera.
- Connect Nano to the host computer GigE network adapter or to the Ethernet switch via a CAT5e or CAT6 Ethernet cable (the switch connects to the computer NIC to be used for imaging, not a corporate network). **Note:** the cable should not be less than 1 meter (3 feet) long or more than 100 meters (328 feet) long.
- Once communication with the host computer is started the automatic IP configuration sequence will assign an LLA IP address as described in section Genie Nano IP Configuration Sequence, or a DHCP IP address if a DHCP server is present on your network (such as the one installed with Sopera LT).
- Check the status LED which will be initially red then switch to flashing blue while waiting for IP configuration. See Camera Status LED for Nano LED display descriptions.

- The factory defaults for Nano is Persistent IP disabled and DHCP enabled with LLA always enabled as per the GigE Vision specification. For additional information see Nano IP Configuration Mode Details. See the next section Connectors for an overview of the Nano interfaces.

Connectors

The Nano has two connectors:

- A single **RJ45 Ethernet** connector for control and video data transmitted to/from the host computer Gigabit NIC. The Genie Nano also supports [Power over Ethernet \(PoE\)](#). See Ruggedized RJ45 Ethernet Cables for secure cables.
- A **10 pin I/O** connector for camera power, plus trigger, strobe and general I/O signals. The connector supports a retention latch, while the Nano case supports thumbscrews. Teledyne DALSA provides optional cables (see Accessories). See 10-pin I/O Connector Details for connector pin out specifications.
- Note that the NanoXL uses the same two connectors but on a larger camera body.

The following figure of the Genie Nano back end shows connector and LED locations. See Mechanical Specifications for details on the connectors and camera mounting dimensions, including the NanoXL.

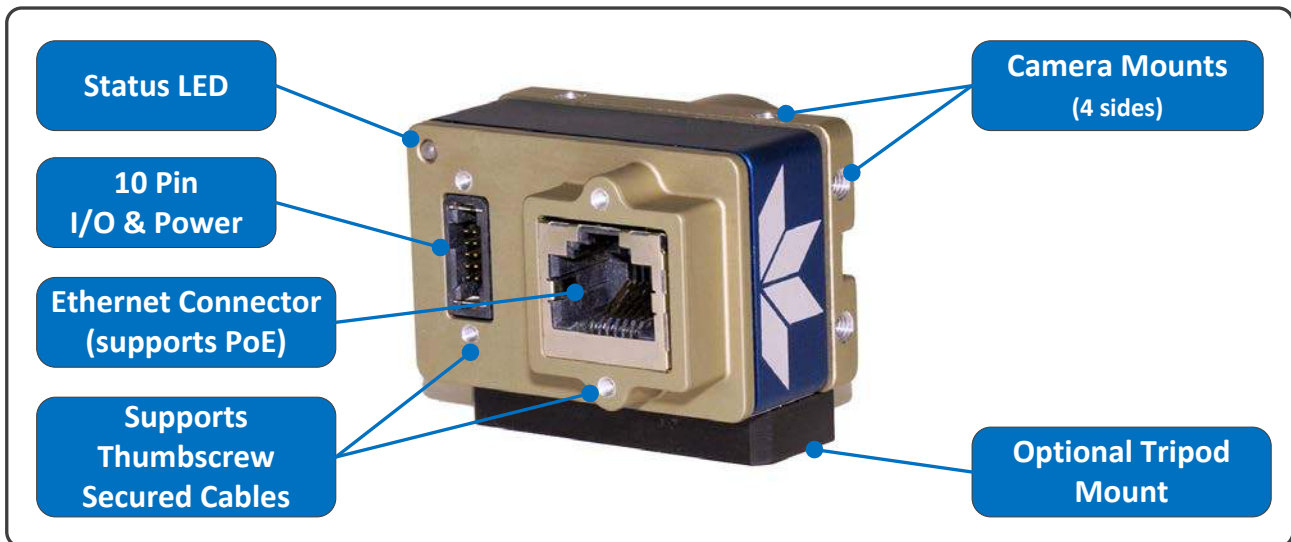

Genie Nano – Rear View

LED Indicators

The Genie Nano has one multicolor LED to provide a simple visible indication of camera state, as described below. The Nano Ethernet connector does not have indicator LEDs; the user should use the LED status on the Ethernet switch or computer NIC to observe networking status.

Camera Status LED Indicator

The camera is equipped with one LED to display its operational status. When more than one condition is active, the LED color indicates the condition with the highest priority (such as – an acquisition in progress has more priority than a valid IP address assignment).

Once the Genie Nano connects to a network and an IP address is assigned, the Status LED will turn to steady blue. Only at this time will it be possible by the GigE Server or any application to communicate with the camera. The following table summarizes the LED states and corresponding camera status.

LED State	Definition
LED is off	No power to the camera
Steady Red	Initial state on power up before flashing. Remains as steady Red only if there is a fatal error. Camera is not initialized **
Flashing Red	Initialization sequence in progress ** Wait less than a minute for the Nano to reboot itself.
Steady Red + Flashing Blue	Fatal Error. If the Genie Nano does not reboot itself contact Technical Support.
Slow Flashing Blue	Ethernet cable disconnected. The camera continuously attempts to assign itself an IP address.
Fast Flashing Blue	File Access Feature is transferring data such as a firmware update, etc.
Steady Blue	IP address assigned; no application connected to the camera
Steady Green	Application connected
Flashing Green	Acquisition in progress. Flashing occurs on frame acquisition but does not exceed a rate of 100ms for faster frame rates.

 **Note:** Even if the Nano has obtained an IP address, it might be on a different subnet than the NIC it is attached to. Therefore, if the Nano LED is blue but an application cannot see it, this indicates a network configuration problem. Review troubleshooting suggestions in the Network Imaging manual.

LED States on Power Up

The following LED sequence occurs when the Genie Nano is powered up connected to a network.

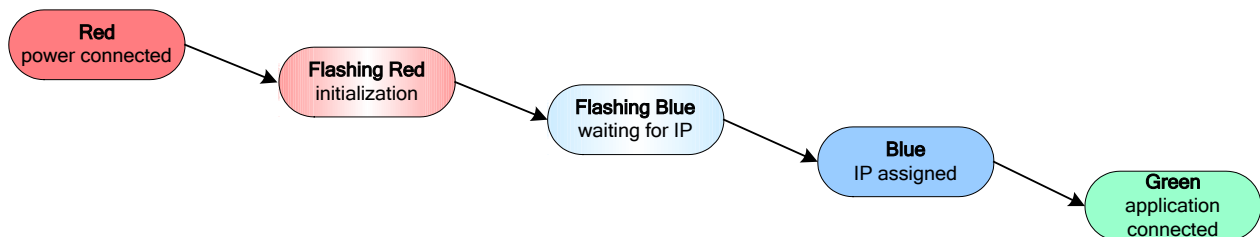

Genie Nano IP Configuration Sequence

The Genie Nano IP (Internet Protocol) Configuration sequence to assign an IP address is executed automatically on camera power-up or when connected to a network. As a GigE Vision compliant device, Nano attempts to assign an IP address as follows.

For any GigE Vision device, the IP configuration protocol sequence is:

- Persistent IP (if enabled)
- DHCP (if a DHCP server is present such as the Teledyne DALSA Smart DHCP server)
- Link-Local Address (always enabled as default)

The factory defaults for Nano is Persistent IP disabled and DHCP enabled with LLA always enabled as per the GigE Vision specification. For additional information see Nano IP Configuration Mode Details.

Supported Network Configurations

The Genie Nano obtains an IP address using the Link Local Address (LLA) or DHCP, by default. If required, a persistent IP address can be assigned (refer to the Network Imaging manual).

Preferably, a DHCP server is present on the network, where the Genie Nano issues a DHCP request for an IP address. The DHCP server then provides the Nano an IP address. The **Teledyne DALSA Network Configuration tool**, installed with the Sapera Teledyne DALSA Network Imaging Package, provides a DHCP server which is easily enabled on the NIC used with the Genie Nano (refer to the Teledyne DALSA Network Imaging user's manual).

The LLA method, if used, automatically assigns the Nano with a randomly chosen address on the 169.254.xxx.xxx subnet. After an address is chosen, the link-local process sends an ARP query with that IP onto the network to see if it is already in use. If there is no response, the IP is assigned to the device, otherwise another IP is selected, and the ARP is repeated. Note that the LLA mode is unable to forward packets across routers.

Preventing Operational Faults due to ESD

	<p>Nano camera installations which do not protect against ESD (electrostatic discharge) may exhibit operational faults. Problems such as random packet loss, random camera resets, and random loss of Ethernet connections, may all be solved by proper ESD management.</p> <p>The Nano camera when used with a simple power supply and Ethernet cable, is not properly connected to earth ground and therefore is susceptible to ESD caused problems. An Ethernet cable has no ground connection and a power supply's 0 volt return line is not necessarily connected to earth ground.</p>
---	---

Teledyne DALSA has performed ESD testing on Nano cameras using an 8 kilovolt ESD generator without any indication of operational faults. The two following methods, either individually or together will prevent ESD problems.

- Method 1: Use a shielded/grounded power supply that connects ground to pin-10 of the I/O connector. The Nano case is now properly connected to earth ground and can withstand ESD of 8 kilovolts, as tested by Teledyne DALSA.
- Method 2: When using Power over Ethernet (PoE), Teledyne DALSA strongly recommends using a shielded Ethernet cable to provide a ground connection from the controlling computer/power supply, to the Genie Nano. PoE requires a powered computer NIC, or a powered Ethernet switch, or an Ethernet power injector.
- Method 3: Mount the camera on a metallic platform with a good connection to earth ground.

Using Nano with Sopera API

A Genie Nano camera installation with the Teledyne DALSA Sopera API generally follows the sequence described below.

Network and Computer Overview

- Nano needs to connect to a computer with a **GigE network adapter**, either built in on the computer motherboard or installed as a third party PCI adapter. See the previous section Connecting the Genie Nano Camera.
- **Laptop computers** with built in **GigE network adapters** may still not be able to stream full frame rates from Nano, especially when on battery power.
- Nano also can connect through a **Gigabit Ethernet switch**. When using VLAN groups, the Nano and controlling computer must be in the same group (refer to the Teledyne DALSA Network Imaging Package user's manual).
- If Genie Nano is to be used in a **Sopera development environment**, Sopera LT 8.10 needs to be installed, which includes the **GigE Vision Module** software package with the Teledyne DALSA **GigE Vision TurboDrive Technology** module.
- If Genie Nano will be used in a **third party GigE Vision Compliant environment**, Sopera or Sopera runtime is not required and you need to follow the installation instructions of the third party package.
- The **Windows Firewall** exceptions feature is automatically configured to allow the Sopera GigE Server to pass through the firewall.
- Computers with **VPN software** (virtual private network) may need to have the VPN driver disabled in the NIC properties. This would be required only on the NIC used with the Nano. Testing by the user is required.
- Once a Nano is connected, look at the small camera icon added to the Windows tray (next to the clock). Ensure the Nano camera has been found (right click the icon and select Status) Note that in Windows 7, the icon remains hidden until a camera is connected.
- **A new Nano installation typically requires a firmware update.** The [File Selector](#) feature is used to select a firmware file. See the CamExpert procedure Updating Firmware via File Access in CamExpert for additional information.
- Use CamExpert (installed either with Sopera or Sopera runtime) to test the installation of the Nano camera. Set the Nano to internal test pattern. See Internal Test Pattern Generator.
- Set up the other components of the imaging system such as light sources, camera mounts, optics, encoders, trigger sources, etc. Test with CamExpert.

Installation



Note: to install Sapera LT and the GigE Vision package, logon to the workstation as an administrator or with an account that has administrator privileges.

When Genie Nano is used in a **Sapera development environment, Sapera LT 8.10 (or later)** needs to be installed, which automatically provides all GigE Vision camera support including TurboDrive.

If no Sapera development is required. Then the Sapera LT SDK is not needed to control the Linea GigE camera. Sapera runtime with CamExpert provides everything to control the camera.

Procedure

- Download and install Sapera LT 8.10 (or later) which automatically provides GigE Vision support with Teledyne DALSA TurboDrive™ technology. Note that Nano features may change when an older versions of Sapera LT is used.
- Optional: If the Teledyne DALSA Sapera LT SDK package is not used, click to install the Genie Nano firmware and user manuals only. Follow the on screen prompts.
- Connect the camera to an available free Gigabit NIC that's not part of some other corporate network.

Refer to Sapera LT User's Manual concerning application development with Sapera.



Note: The Teledyne DALSA Sapera CamExpert tool (used throughout this manual to describe Genie Nano features) is installed with either the Sapera LT runtime or the Sapera LT development package.

Camera Firmware Updates

Under Windows, the user can upload new firmware, using the [File Access Control](#) features provided by the Sapera CamExpert tool.



Important: Download the latest firmware version released for any Nano model from the Teledyne DALSA support web page: <http://www.teledynedalsa.com/imaging/support/downloads/firmware/>

Firmware via Linux or Third Party Tools

Consult your third party GigE Vision software package for file uploads to the connected device.

GigE Server Verification

After a successful Genie Nano Framework package installation, the GigE Server icon is visible in the desktop taskbar tray area (note that in Windows 7 the icon remains hidden until a camera is connected). After connecting a camera (see following section), allow a few seconds for the GigE Server status to update. The Nano camera must be on the same subnet as the NIC to be recognized by the GigE Server.

	Device Available	Device IP Error	Device Not Available
GigE Server Tray Icon:			
	The normal GigE server tray icon when the Genie device is found. It will take a few seconds for the GigE Server to refresh its state after the Genie has obtained an IP address.	The GigE server tray icon shows a warning when a device is connected but there is some type of IP error.	A red X will remain over the GigE server tray icon when the Genie device is not found. This indicates a major network issue. Or in the simplest case, the Genie is not connected.

If you place your mouse cursor on this icon, the GigE Server will display the number of GigE Vision devices found by your PC. Right click the icon and select status to view information about those devices. See Troubleshooting for more information.

GigE Server Status

Once the Genie Nano is assigned an IP address (its Status LED is steady blue) the GigE server tray icon will not have a red X through it, indicating that the Nano device was found. It might take a few seconds for the GigE Server to refresh its state after the Nano has obtained an IP address.

Right-click the GigE Server tray icon to open the following menu.

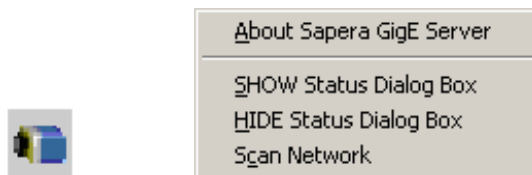

Click on Show Status to open a window listing all devices connected to the host system. Each GigE device is listed by name along with important information such as the assigned IP address and device MAC address. The screen shot below shows a connected Nano with no networking problems.

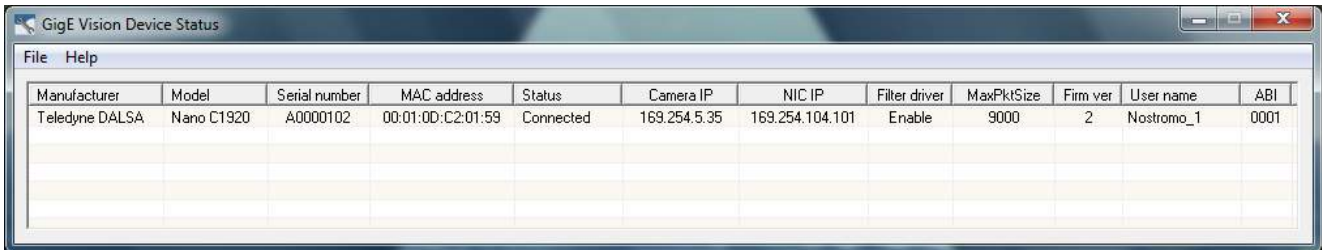

In the event that the device is physically connected, but the Sapera GigE Server icon is indicating that the connected device is not recognized, click Scan Network to restart the discovery process. Note that the GigE server periodically scans the network automatically to refresh its state. See Troubleshooting for network problems.

Optimizing the Network Adapter used with Nano

Most Gigabit network interface controllers (NIC) allow user modifications to parameters such as Adapter Buffers and Jumbo Frames. These should be optimized for use with the Nano during the installation. Refer to the **NetworkOptimizationGuide.pdf** for optimization information (available with the Spera LT installation [C:\Program Files\Teledyne DALSA\Network Interface]).

Quick Test with CamExpert (Windows)

When the Genie Nano camera is connected to a Gigabit network adapter on a host computer, testing the installation with CamExpert is a straightforward procedure.

- Start Spera CamExpert by double clicking the desktop icon created during the software installation.
- CamExpert will search for installed Spera devices. In the Device list area on the left side, the connected Nano camera is shown or will be listed in a few seconds after CamExpert completes the automatic device search (device discovery).
- Select the Nano camera device by clicking on the camera user defined name. By default the Nano camera is identified by its serial number. The Nano status LED will turn green, indicating the CamExpert application is now connected.
- Click on the Grab button for live acquisition (the Nano default is Free Running mode). Focus and adjust the lens iris. See Operational Reference for information on CamExpert parameters with the Nano camera.
- If the Nano has no lens, just select one of the internal test patterns available (*Image Format Controls – Test Image Selector*). All but one are static images to use with the Snap or Grab function of CamExpert. The single “moving” test image is a shifting diagonal ramp pattern, which is useful for testing network/computer bandwidth issues (see following image).
- Refer to the Teledyne DALSA Network Imaging package manual if error messages are shown in the Output Messages pane while grabbing.

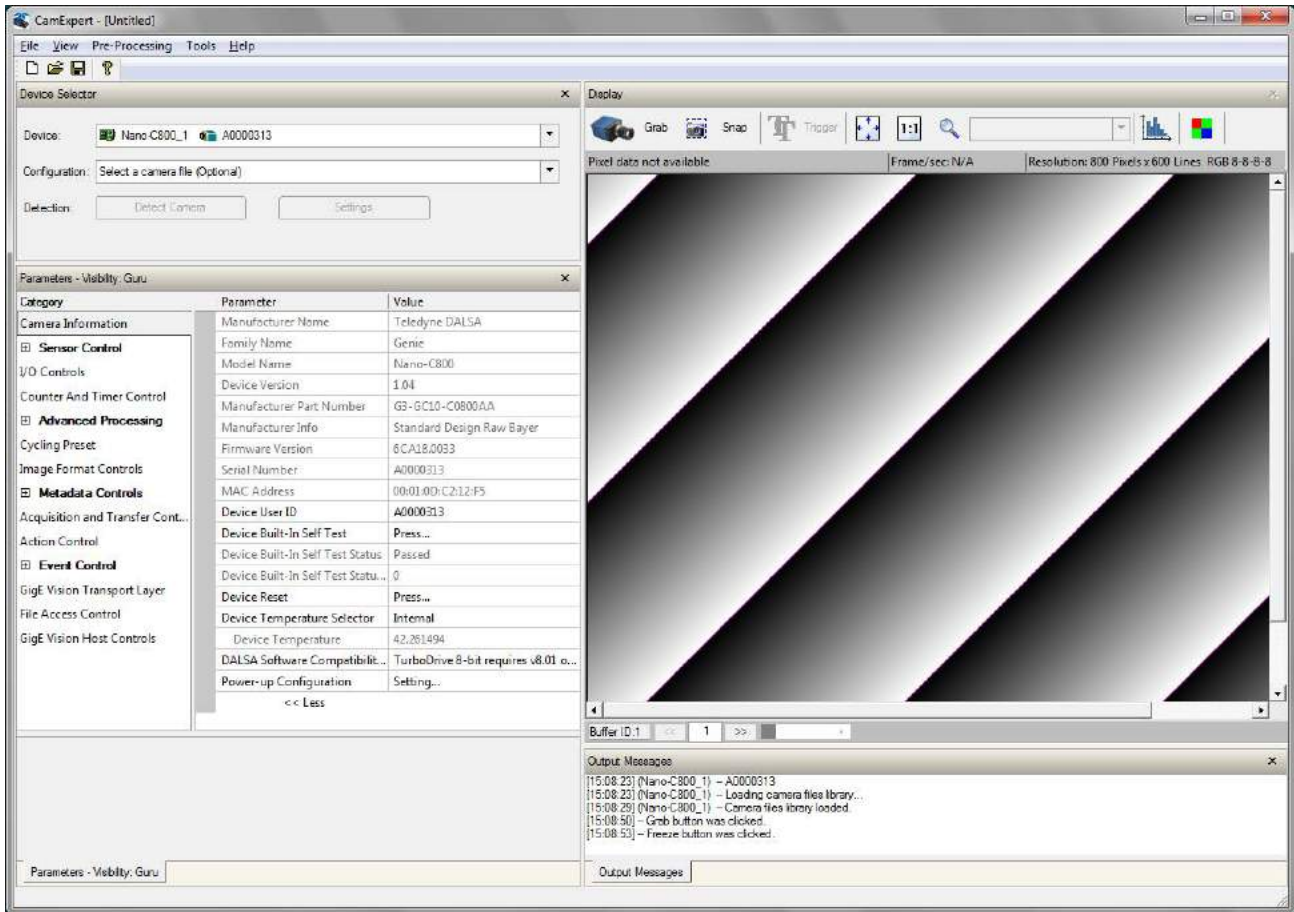

About the Device User ID

The Nano can be programmed with a user defined name to aid identifying multiple cameras connected to the network. For instance, on an inspection system with 4 cameras, the first camera might be labeled "top view", the second "left view", the third "right view" and the last one "bottom view". The factory default user name is set to match the camera serial number for quick initial identification. Note that the factory programmed Genie Nano serial number and MAC address are not user changeable.

When using CamExpert, multiple Genie Nano cameras on the network are seen as different "Nano-xxxxx" devices as an example. Non Teledyne DALSA cameras are labeled as "GigE Vision Device". Click on a device user name to select it for control by CamExpert.

An imaging application uses any one of these attributes to identify a camera: its IP address, MAC address, serial number or User Name. Some important considerations are listed below.

- Do not use the camera's IP address as identification (unless it is a persistent IP) since it can change with each power cycle.
- A MAC address is unique to a single camera, therefore the control application is limited to the vision system with that unique camera if it uses the camera's MAC address.
- The User Name can be freely programmed to clearly represent the camera usage. This scheme is recommended for an application to identify cameras. In this case, the vision system can be duplicated any number of times with cameras identified by their function, not their serial numbers or MAC address.

Operational Reference

Using CamExpert with Genie Nano Cameras

The Sapera CamExpert tool is the interfacing tool for GigE Vision cameras, and is supported by the Sapera library and hardware. CamExpert allows a user to test camera functions. Additionally CamExpert saves the Nano user settings configuration to the camera or saves multiple configurations as individual camera parameter files on the host system (*.ccf).



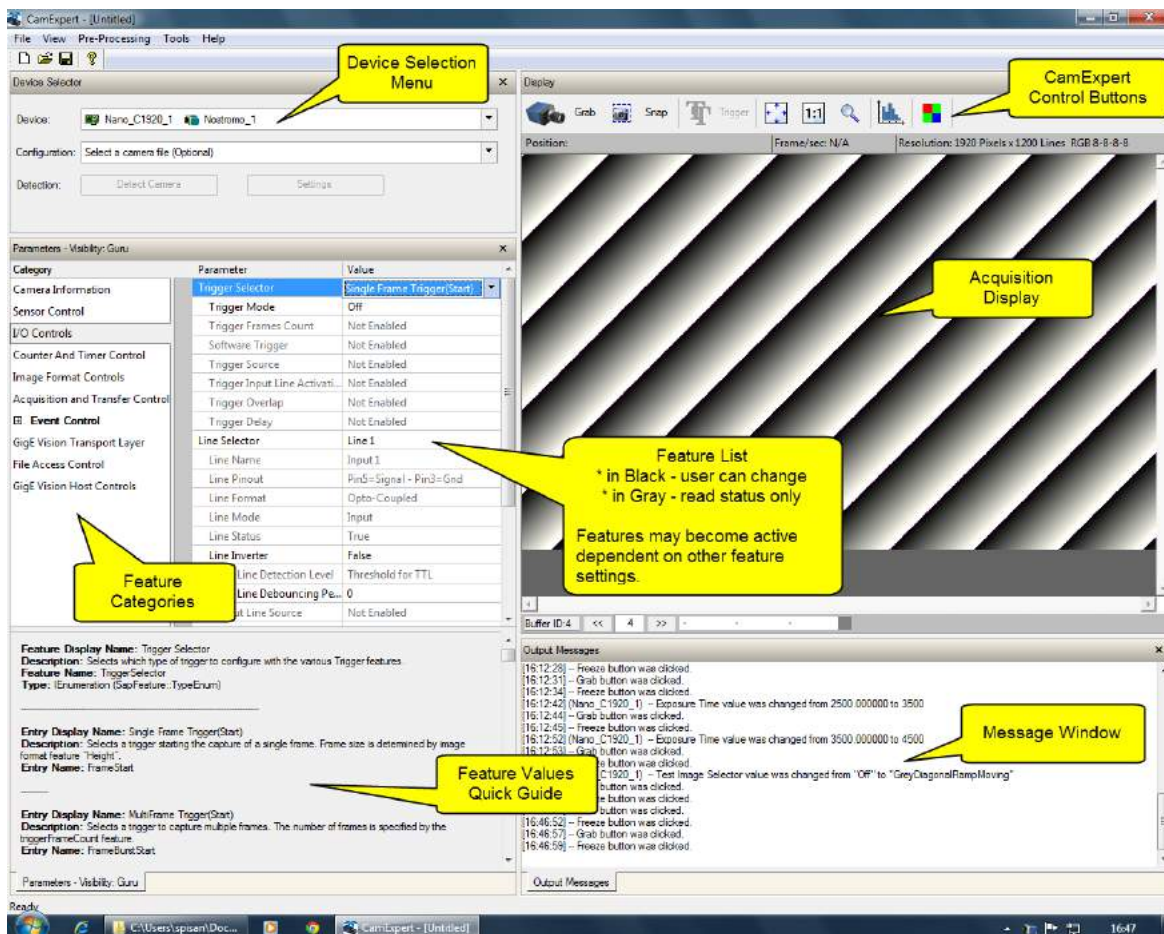

An important component of CamExpert is its live acquisition display window which allows immediate verification of timing or control parameters without the need to run a separate acquisition program.

CamExpert Panes

The various areas of the CamExpert tool are described in the summary figure below. GigE Vision device Categories and Parameter features are displayed as per the device's XML description file. The number of parameters shown is dependent on the View mode selected (i.e. Beginner, Expert, Guru – see description below).

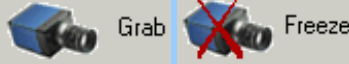

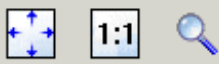
- **Device pane:** View and select from any installed GigE Vision or Samera acquisition device. After a device is selected CamExpert will only present parameters applicable to that device.
- **Parameters pane:** Allows viewing or changing all acquisition parameters supported by the acquisition device. CamExpert displays parameters only if those parameters are supported by the installed device. This avoids confusion by eliminating parameter choices when they do not apply to the hardware in use.
- **Display pane:** Provides a live or single frame acquisition display. Frame buffer parameters are shown in an information bar above the image window.
- **Control Buttons:** The Display pane includes CamExpert control buttons. These are:

	<p>Acquisition control button: Click once to start live grab, click again to stop.</p>
	<p>Single frame grab: Click to acquire one frame from device.</p>
	<p>Software trigger button: With the I/O control parameters set to Trigger Enabled / Software Trigger type, click to send a single software trigger command.</p>
	<p>CamExpert display controls: (these do not modify the frame buffer data) Stretch (or shrink) image to fit, set image display to original size, or zoom the image to any size and ratio. Note that under certain combinations of image resolution, acquisition frame rate, and host computer speed, the CamExpert screen display may not update completely due to the host CPU running at near 100%. This does not affect the acquisition.</p>
	<p>Histogram / Profile tool: Select to view a histogram or line/column profile during live acquisition.</p>

- **Output pane:** Displays messages from CamExpert or the GigE Vision driver.

CamExpert View Parameters Option

All camera features have a Visibility attribute which defines its requirement or complexity. The states vary from Beginner (features required for basic operation of the device) to Guru (optional features required only for complex operations).

CamExpert presents camera features based on their visibility attribute and provides quick Visibility level selection via controls below each Category Parameter list [<< Less More >>]. The user can also choose the Visibility level from the *View · Parameters Options* menu.

Camera Information Category

Camera information can be retrieved via a controlling application. Parameters such as camera model, firmware version, etc. are read to uniquely identify the connected Nano device. These features are typically read-only. GigE Vision applications retrieve this information to identify the camera along with its characteristics.

Features listed in the description table but tagged as *Invisible* are usually for Teledyne DALSA or third party software usage—not typically needed by end user applications.

Category	Parameter	Value
Camera Information	Manufacturer Name	Teledyne DALSA
☒ Sensor Control	Family Name	Genie
I/O Controls	Model Name	Nano-C800
Counter And Timer Control	Device Version	1.04
☒ Advanced Processing	Manufacturer Part Number	G3-GC10-C0800AA
Color Processing	Manufacturer Info	Standard Design Raw Bayer
Cycling Preset	Firmware Version	6CA18.0033
Image Format Controls	Serial Number	A0000313
☒ Metadata Controls	MAC Address	00:01:0D:C2:12:F5
Chunk Parser	Device User ID	A0000313
Acquisition and Transfer Control	Device Built-In Self Test	Press...
Action Control	Device Built-In Self Test Status	Passed
☒ Event Control	Device Built-In Self Test Status All	0
☒ Event Info	Device Reset	Press...
GigE Vision Transport Layer	Device Temperature Selector	Internal
File Access Control	Device Temperature	41.400208
GigE Vision Host Controls	DALSA Software Compatibility Component List	TurboDrive 8-bit requires v8.01 or greater
	Power-up Configuration	Setting...
	<< Less	

Camera Information Feature Descriptions

The following table describes these parameters along with their view attribute and in which device version the feature was introduced. Additionally the Device Version column will indicate which parameter is a member of the DALSA Features Naming Convention (indicated by **DFNC**), versus the GenICam Standard Features Naming Convention (SFNC tag is not shown).

New features for a major device version release will be indicated by **green text** for easy identification.

Display Name	Feature & Values	Description	Device Version & View
Manufacturer Name	DeviceVendorName	Displays the device vendor name.	1.00 Beginner
Family Name	DeviceFamilyName	Displays the device family name.	1.00 Beginner
Model Name	DeviceModelName	Displays the device model name.	1.00 Beginner
Device Version	DeviceVersion	Displays the device version. This tag will also highlight if the firmware is a beta or custom design. (RO)	1.00 Beginner
Manufacturer Part Number	deviceManufacturerPartNumber	Displays the device manufacturer part number.	1.00 DFNC Beginner
Manufacturer Info	DeviceManufacturerInfo	This feature provides extended manufacturer information about the device. Genie Nano cameras show which firmware design is currently loaded.	1.00 Beginner
Firmware Version	DeviceFirmwareVersion	Displays the currently loaded firmware version number. Firmware files have a unique number and have the .cbf file extension.	1.00 Beginner
Serial Number	DeviceSerialNumber	Displays the device's factory set serial number.	1.00 Expert
MAC Address	deviceMacAddress	Displays the unique MAC (Media Access Control) address of the Device.	1.00 DFNC Beginner
Device User ID	DeviceUserID	Feature to store a user-programmable identifier of up to 15 characters. The default factory setting is the camera serial number. (RW)	1.00 Beginner
Device Built-In Self Test	deviceBIST	Command to perform an internal test which will determine the device status. (W)	1.00 Beginner
Device Built-In Self Test Status	deviceBISTStatus	Return the status of the device Built-In Self-Test. Possible return values are device-specific.	1.00 Beginner
<i>Passed</i>	<i>Passed</i>	<i>No failure detected</i>	
<i>Last firmware update failed</i>	<i>FirmwareUpdateFailure</i>	<i>Last firmware update operation failed.</i>	
<i>Unexpected Error</i>	<i>Unexpected_Error</i>	<i>Switched to recovery mode due to unexpected software error.</i>	
<i>Sensor Initialization Failure</i>	<i>SensorFailure</i>	<i>There was an error initializing the sensor. The camera may not be able to capture images. (1.05)</i>	
<i>Firmware Error</i>	<i>FirmwareError</i>	<i>Firmware encountered an error during streaming. (1.06)</i>	
Device Built-In Self Test Status All	deviceBISTStatusAll	Return the status of the device Built-In Self-Test as a bitfield. The meaning for each bit is device-specific. A value of 0 indicates no error. Bit-0=1:Firmware Update Failure Bit-2=1:Unexpected Error	1.00 DFNC Beginner
Device Reset	DeviceReset	Resets the device to its power up state. (W)	1.00 Beginner
Device Temperature Selector	DeviceTemperatureSelector	Select the source where the temperature is read.	1.00 Beginner
<i>Internal</i>	<i>Internal</i>	<i>Value from FPGA and or PHY temperature.</i>	
<i>MaxInternal</i>	<i>MaxInternal</i>	<i>Records the highest device temperature since power up. Value is reset on power off.</i>	

Device Temperature	DeviceTemperature	The temperature of the selected source in degrees Celsius. Maximum temperature should not exceed +70°C for reliable operation.	1.00 Beginner
DALSA Software Compatibility Component List	DALSASoftwareCompatibilityComponentList	List the optional Teledyne DALSA software functions that are supported.	1.00 Beginner
<i>TurboDrive 8-bit requires v8.01 or greater</i>	<i>Compatibility1</i>	<i>Teledyne DALSA Turbo Drive 8-bit (Monochrome or Bayer) requires Sapera-LT 8.01 or greater.</i>	
<i>TurboDrive 10-bit requires v8.10 or greater</i>	<i>Compatibility2</i>	<i>Teledyne DALSA Turbo Drive 10-bit (Monochrome or Bayer) requires Sapera-LT 8.10 or greater.</i>	
<i>TurboDrive 12-bit requires v8.10 or greater</i>	<i>Compatibility3</i>	<i>Teledyne DALSA Turbo Drive 12-bit (Monochrome or Bayer) requires Sapera-LT 8.10 or greater.</i>	
<i>Multicast requires a newer version</i>	<i>Compatibility4</i>	<i>Multicast feature support requires a newer version of Sapera LT than currently installed.</i>	
<u>Power-up Configuration Selector</u>	UserSetDefaultSelector	Selects the camera configuration set to load and make active on camera power-up or reset. The camera configuration sets are stored in camera non-volatile memory. (RW)	1.00 Beginner
<i>Factory Setting</i>	<i>Default</i>	<i>Load factory default feature settings.</i>	
<i>UserSet1</i>	<i>UserSet1</i>	<i>Select the user defined configuration UserSet 1 as the Power-up Configuration.</i>	
<i>UserSet2</i>	<i>UserSet2</i>	<i>Select the user defined configuration UserSet 2 as the Power-up Configuration.</i>	
<u>User Set Selector</u>	UserSetSelector	Selects the camera configuration set to load feature settings from or save current feature settings to. The Factory set contains default camera feature settings. (RW)	1.00 Beginner
<i>Factory Setting</i>	<i>Default</i>	<i>Select the default camera feature settings saved by the factory.</i>	
<i>UserSet 1</i>	<i>UserSet1</i>	<i>Select the User Defined Configuration space UserSet1 to save to or load from features settings previously saved by the user.</i>	
<i>UserSet 2</i>	<i>UserSet2</i>	<i>Select the User Defined Configuration space UserSet1 to save to or load from features settings previously saved by the user.</i>	
Load Configuration	UserSetLoad	Loads the camera configuration set specified by the User Set Selector feature, to the camera and makes it active. Can not be updated during a Sapera transfer. (W)	1.00 Beginner
Save Configuration	UserSetSave	Saves the current camera configuration to the user set specified by the User Set Selector feature. The user sets are located on the camera in non-volatile memory. (W)	1.00 Beginner
Power-up Configuration Selector	UserSetDefault	Specify the camera configuration set to load and make active on camera power-up or reset. The camera configuration sets are stored in camera non-volatile memory.	1.00 Beginner
Serial Number	DeviceID	Displays the device's factory set camera serial number.	1.00 Invisible
<i>Factory Setting</i>	<i>Default</i>	<i>Select the Factory Setting values as the Power-up Configuration.</i>	1.00 Invisible
<i>UserSet1</i>	<i>UserSet1</i>	<i>Select the user defined configuration UserSet 1 as the Power-up Configuration.</i>	
<i>UserSet2</i>	<i>UserSet2</i>	<i>Select the user defined configuration UserSet 2 as the Power-up Configuration.</i>	

Calibration Date	deviceCalibrationDateRaw	Date when the camera was calibrated.	
Device Acquisition Type	deviceAcquisitionType	Displays the Device Acquisition Type of the product.	1.00 DFNC Invisible
Sensor	Sensor	The device gets its data directly from a sensor.	
Device TL Type	DeviceTLType	Transport Layer type of the device.	1.00 DFNC Invisible
GigE Vision	GigEVision	GigE Vision Transport Layer	
Device TL Version Major	DeviceTLVersionMajor	Major version of the device's Transport Layer.	1.00 Invisible
Device TL Version Minor	DeviceTLVersionMinor	Minor version of the device's Transport Layer.	
	userSetError	Error Flags for UserSetLoad & UserSetSave	1.00 Invisible
	NoError	No Error	
	LoadGenericError	Unknown error	
	LoadBusyError	The camera is busy and cannot perform the action	
	LoadMemoryError	Not enough memory to load set	
	LoadFileError	Internal file I/O error	
	LoadInvalidSetError	At least one register could not be restored properly	
	LoadResourceManagerError	An internal error happened related to the resource manager	
	SaveGenericError	Unknown error	
	SaveBusyError	The camera is busy and cannot perform the action	
	SaveMemoryError	Camera ran out of memory while saving set	
	SaveFileError	Internal file I/O error	
	SaveInvalidSetError	An invalid user set was requested	
	SaveResourceManagerError	An internal error happened related to the resource manager	
DFNC Major Rev	deviceDFNCVersionMajor	Major revision of Dalsa Feature Naming Convention which was used to create the device's XML.	1.00 DFNC Invisible
DFNC Minor Rev	deviceDFNCVersionMinor	Minor revision of Dalsa Feature Naming Convention which was used to create the device's XML.	1.00 DFNC Invisible
SFNC Major Rev	DeviceSFNCVersionMajor	Major Version of the Genicam Standard Features Naming Convention which was used to create the device's XML.	1.00 DFNC Invisible
SFNC Minor Rev	DeviceSFNCVersionMinor	Minor Version of the Genicam Standard Features Naming Convention which was used to create the device's XML.	1.00 DFNC Invisible
SFNC SubMinor Rev	DeviceSFNCVersionSubMinor	SubMinor Version of the Genicam Standard Features Naming Convention which was used to create the device's XML.	1.00 Invisible

Power-up Configuration Dialog

CamExpert provides a dialog box which combines the features to select the camera power-up state and for the user to save or load a Nano camera state.

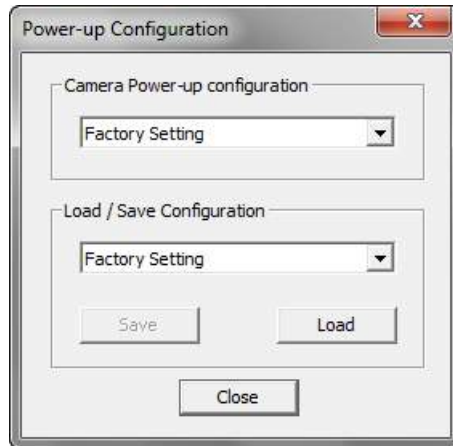

Camera Power-up Configuration

The first drop list selects the camera configuration state to load on power-up (see feature *UserSetDefaultSelector*). The user chooses from one factory data set or one of two possible user saved states.

Load / Save Configuration

The second drop list allows the user to change the camera configuration any time after a power-up (see feature *UserSetSelector*). To reset the camera to the factory configuration, select *Factory Setting* and click Load. To save a current camera configuration, select User Set 1 or 2 and click Save. Select a saved user set and click Load to restore a saved configuration.

Sensor Control Category

The Genie Nano sensor controls, as shown by CamExpert, groups sensor specific parameters. This group includes controls for frame rate, exposure time, gain, etc. Parameters in gray are read only, either always or due to other feature settings. Parameters in black are user set in CamExpert or programmable via an imaging application.

Features listed in the description table that are tagged as *Invisible* are usually for Teledyne DALSA or third party software usage—not typically needed by end user applications. Also important, features shown by CamExpert may change with different Genie Nano models implementing different sensors, image resolutions, and color versions.



Category	Parameter	Value
Camera Information	Device Scan Type	Areascan
Sensor Control	Sensor Color Type	Bayer Sensor
Auto-Brightness	Input Pixel Size	10 Bits/Pixel
I/O Controls	Sensor Width	832
Counter And Timer Control	Sensor Height	632
Advanced Processing	Acquisition Frame Rate Control Mode	Programmable
Cycling Preset	Acquisition Frame Rate	10.0
Image Format Controls	Exposure Mode	Timed
Metadata Controls	Exposure Alignment	Synchronous
Acquisition and Transfer Cont...	Exposure Delay	Not Enabled
Action Control	Exposure Time	1837
Event Control	Actual Exposure Time	Not Enabled
GigE Vision Transport Layer	Sensor Shutter Mode	Global
File Access Control	Gain Selector	Sensor Analog
GigE Vision Host Controls	Gain	1.0
	Gain (Raw)	1
	Black Level Selector	Analog
	Black Level	5.0
	Fast Readout Mode	Active
	Sensor FPN Correction Mode	Off
	<< Less	

Sensor Control Feature Descriptions

The following table describes these features along with their view attribute and device version. For each feature the device version may differ for each camera sensor available.

When a Device Version number is indicated, this represents the camera software functional group, not a firmware revision number. As Genie Nano capabilities evolve the device version will increase, therefore identifying the supported function package. New features for a major device version release will be indicated by **green text** for easy identification.

The first column indicates whether a feature applies to monochrome or color camera models via a symbol. No symbol indicates a common feature. Additionally the description column will indicate which feature is a member of the DALSA Features Naming Convention (indicated by DFNC), versus the GenICam Standard Features Naming Convention (SFNC tag is not shown).

B/W Color	Display Name	Feature & Values	Description	Notes
	Device Scan Type	DeviceScanType	Defines the scan type of the device's sensor. Genie Nano is an Areascan camera. < RO, Beginner >	
	<i>Areascan</i>	<i>Areascan</i>	<i>Device uses an Areascan sensor.</i>	
	Sensor Color Type	sensorColorType	Defines the camera sensor color type. < RO, DFNC, Beginner >	
	<i>Monochrome Sensor</i>	<i>Monochrome</i>	<i>Sensor color type is monochrome.</i>	
	<i>Bayer Sensor</i>	<i>CFA_Bayer</i>	<i>Sensor color type is Bayer Color Filter Array (CFA).</i>	
	Input Pixel Size	pixelSizeInput	Size of the image input pixels, in bits per pixel. < RO, DFNC, Guru >	
	<i>8 Bits/Pixel</i>	<i>Bpp8</i>	<i>Sensor output data path is 8 bits per pixel.</i>	
	<i>10 Bits/Pixel</i>	<i>Bpp10</i>	<i>Sensor output data path is 10 bits per pixel.</i>	
	<i>12 Bits/Pixel</i>	<i>Bpp12</i>	<i>Sensor output data path is 12 bits per pixel.</i>	
	Sensor Width	SensorWidth	Defines the sensor width in active pixels. < RO, Expert >	
	Sensor Height	SensorHeight	Defines the sensor height in active lines. < RO, Expert >	
	Acquisition Frame Rate Control Mode	acquisitionFrameRateControlMode	Set the frame control method used in free running mode. Note that this feature applies only to sensor acquisitions, not internal test images. < 1.01, DFNC, Guru >	
	<i>Programmable</i>	<i>Programmable</i>	<i>The camera frame rate is controlled by the AcquisitionFrameRate feature.</i>	
	<i>Maximum Speed</i>	<i>MaximumSpeed</i>	<i>The camera operates at its maximum frame rate using the current exposure (time and delay) configuration.</i>	
	Acquisition Frame Rate	AcquisitionFrameRate	Specifies the camera internal frame rate, in Hz. Any user entered value is automatically adjusted to a valid camera value. Note that a change in frame rate takes effect only when the acquisition is stopped and restarted. < Beginner >	

	Exposure Mode	ExposureMode	Sets the operation mode for the camera's exposure (or electronic shutter). < Beginner >	
	<i>Timed</i>	<i>Timed</i>	<i>The exposure duration time is set using the Exposure Time feature and the exposure starts with a FrameStart event.</i>	
	<i>Trigger Width</i>	<i>TriggerWidth</i>	<i>Uses the width of the trigger signal pulse to control the exposure duration. Use the Trigger Activation feature to set the polarity of the trigger. The Trigger Width setting is applicable with Trigger Selector = Single Frame Trigger(Start).</i>	
	Exposure Alignment	exposureAlignment	Exposure Alignment specifies how the exposure is executed in relationship to the sensor capabilities and current frame trigger. < DFNC Beginner >	
	<i>Synchronous</i>	<i>Synchronous</i>	<i>Exposure is synchronous to the internal timing of the sensor. The readout is concurrent to the exposure for the fastest possible frame rate. When a valid trigger is received and the ExposureTime is shorter than the readout period, the ExposureStart event is latched in the previous frame's readout. That is; the ExposureStartEvent is delayed and is initiated when the actual exposure starts such that the exposure ends and readout begins as soon as the previous readout has completed.</i>	
	<i>Reset</i>	<i>Reset</i>	<i>Sensor timing is reset to initiate exposure when a valid trigger is received. Readout is sequential to exposure, reducing the maximum achievable frame rates. That is, a trigger received during exposure or readout is ignored since data would be lost by performing a reset.</i>	
	Exposure Delay	exposureDelay	Specifies the delay in microseconds (μ s) to apply after the FrameStart event before starting the ExposureStart event. < DFNC Beginner >	
	Exposure Time	ExposureTime	Sets the exposure time (in microseconds) when the Exposure Mode feature is set to Timed. < Beginner >	
	Actual Exposure Time	exposureTimeActual	Actual Exposure Time performed by sensor due to its design, based on the requested Exposure Time. < Beginner >	
	Sensor Shutter Mode	SensorShutterMode	States or selects the supported shutter mode of the device. < Beginner >	Ver. 1.06
	<i>Global</i>	<i>Global</i>	<i>The shutter exposes all pixels at the same time.</i>	
	<i>Global Reset</i>	<i>GlobalReset</i>	<i>The shutter opens at the same time for all pixels but ends in a line sequential manner.</i>	
	<i>Rolling</i>	<i>Rolling</i>	<i>The shutter opens and closes sequentially for groups (typically lines) of pixels.</i>	
	Gain Selector	GainSelector	Selects which gain is controlled when adjusting gain features. < Beginner >	
	<i>Sensor</i>	<i>SensorAll</i>	<i>Apply a gain adjustment within the sensor to the entire image. The first half of the gain range is applied in the analog domain and the second half is digital.</i>	
	<i>Sensor Analog</i>	<i>SensorAnalog</i>	<i>Apply an analog gain adjustment within the sensor to the entire image.</i>	Ver. 1-02
	<i>Sensor Digital</i>	<i>SensorDigital</i>	<i>Apply a digital gain adjustment within the sensor to the entire image.</i>	Ver. 1.02
	<i>Digital</i>	<i>DigitalAll</i>	<i>Apply a digital gain adjustment to the entire image. This independent gain factor is applied to the image after the sensor.</i>	
	Gain	Gain	Sets the selected gain as an amplification factor applied to the image. User adjusts the <i>Gain</i> feature or the <i>GainRaw</i> feature. < Beginner >	
	Gain (Raw)	GainRaw	Raw Gain value that is set in camera (Model Specific for range and step values). < Guru >	

	Black Level Selector	BlackLevelSelector	Selects which Black Level to adjust using the Black Level features. < Beginner >	
	<i>Analog</i>	<i>AnalogAll</i>	<i>Sensor Dark Offset</i>	
	Black Level	BlackLevel	Controls the black level as an absolute physical value. This represents a DC offset applied to the video signal, in DN (digital number) units. The Black Level Selector feature specifies the channel to adjust. < Beginner >	
	Fast Readout Mode	fastReadoutMode	Selects the sensor's readout mode. < Guru, 1.01 >	ver. 1.02
	<i>Off</i>	<i>Off</i>	<i>When this mode is off, the row blanking and row readout occur sequentially in the sensor.</i>	
	<i>Active</i>	<i>Active</i>	<i>When this mode is active, the row blanking and row readout occur in parallel in the sensor. This helps achieve a lower total frame readout time resulting in a faster maximum frame rate. There are minor DN column artifacts, typically of no significance.</i>	
	Sensor FPN Correction Mode	sensorFpnCorrectionMode	Activation mode for the sensor Fixed Pattern Noise correction function. < Guru, 1.01 >	ver. 1.02
	<i>Off</i>	<i>Off</i>	<i>Disables the sensor FPN Correction Mode</i>	
	<i>Active</i>	<i>Active</i>	<i>Enables the sensor FPN Correction Mode.</i> <i>Note: Applicable to the models listed below</i> <i>M640, M640 NIR, C640</i> <i>M800, M800 NIR, C800</i> <i>M1280, M1280 NIR, C1280</i>	

Offset/Gain Control Details (Sony sensors)

The Gain and Black level functions are applied at the sensor and/or on the digital image values output by the sensor, as described below.

- **Gain Selector = Sensor:** The gain function is a linear multiplier control in 0.01 steps within the sensor hardware (range is "1-251", which is a +48dB maximum gain).
- **Gain:** Sensor gain is applied first by an analog amplifier (multiplier range of "1-15.85", i.e. +24dB) and then continues automatically via a digital amplifier as shown in the graphic below.
- **Important:** Digital noise increases linearly and quickly with higher gain values. Users should evaluate image quality with added gain.
- **Gain (Raw):** Provides an alternative method to control sensor gain, where values entered are in 0.1dB increments. Therefore the range is 0 to 480 which controls a 0 to 48dB gain range.
- **Gain Selector = Digital:** The gain function controls the post sensor digital amplifier (available only on some models of Nano cameras). This gain factor is independent of any sensor gain set. This setting is a linear multiplying number of 1 to 4, in 0.1 steps).
- **Black Level:** This offset variable exists within the sensor. The Sony sensors allow an offset range between 0 and 511 DN. The factory settings default value for each sensor used by various Nano models, is recommended as per the sensor manufacturer design specifications.

Note: With the factory default offset, testing a camera's black output in 8-bit mode may show a 2 DN value difference across the image. Changing the Black Level value up or down will push sensor noise (present at the sensors native bits per pixel) to fall within one 8-bit value, thus the noise becomes hidden.

Sony Sensors Gain Stage Diagram

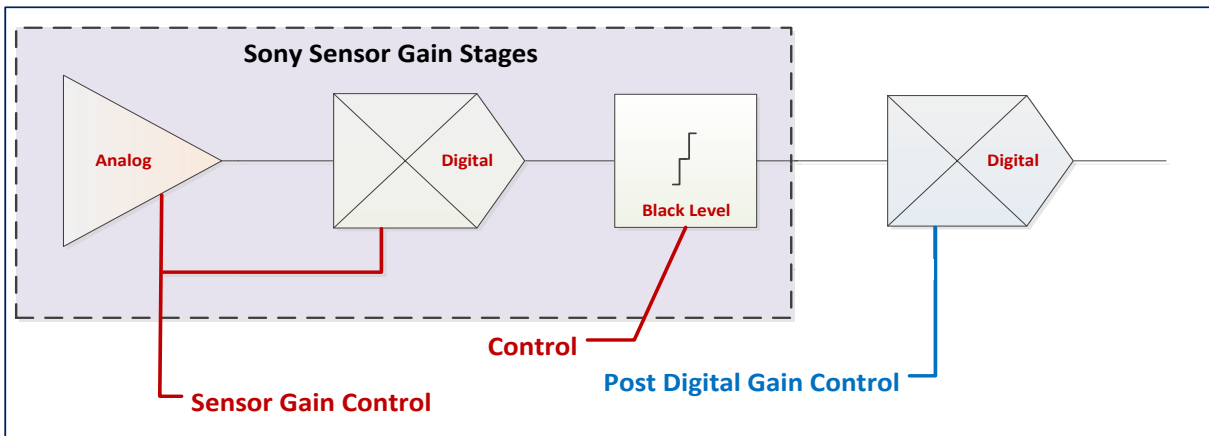

Offset/Gain Control Details (On-Semi Python sensors)

The Gain and Black level functions are applied at the sensor and/or on the digital image values output by the sensor, as described below.

- **Gain Selector = Sensor Analog:** The gain function is a linear multiplier control in 0.01 steps within the sensor hardware (**Gain** range is "1-8", which is a +18dB gain).
- **Gain Selector = Sensor Digital:** The gain function is a linear multiplier control in 0.01 steps within the sensor hardware (**Gain** range is "1-31.99", which is +30dB gain).
- **Important:** Digital noise increases linearly and quickly with higher gain values. Users should evaluate image quality with added gain.
- **Gain (Raw):** Shows the raw sensor control for each gain stage or an alternative method to control sensor gain.
- **Black Level:** This offset variable exists within the sensor. The On-Semi sensors allow an offset range between 0 and 255 DN. The factory settings default value for each sensor used by various Nano models, is recommended as per the sensor manufacturer design specifications.

Note: With the factory default offset, testing a camera's black output in 8-bit mode may show a 2 DN value difference across the image. Changing the Black Level value up or down will push sensor noise (present at the sensors native bits per pixel) to fall within one 8-bit value, thus the noise becomes hidden.

On-Semi Python Sensors Gain Stage Diagram

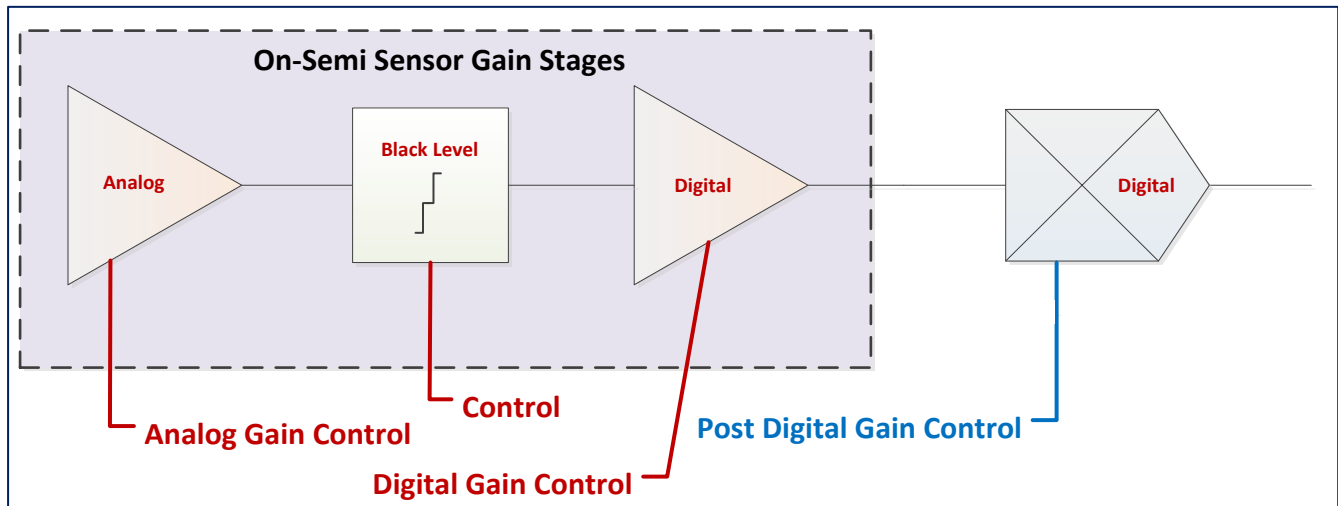

Bayer Mosaic Pattern

Genie Nano Color cameras output raw Bayer image data using the mosaic pattern shown below. Teledyne DALSA Sopera CamExpert tool interprets the raw Bayer output when the user enables the Pre-Processing Software Bayer Decoder. CamExpert also provides an automatic white balance tool to aid RGB gain adjustments.

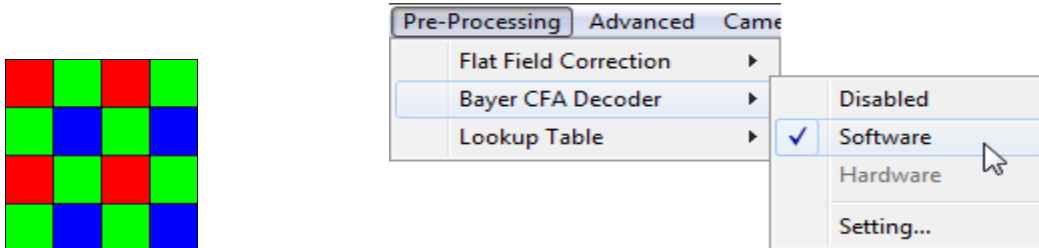

Bayer Mosaic Pattern and the CamExpert processing function to decode the Genie Nano Color

OnSemi Python P1 Sensor Artifacts with Fast Readout Mode

Nano OnSemi (Python P1) sensor camera models with Fast Readout mode active have the row blanking and row readout occur in parallel in the sensor. This reduces the total frame readout time resulting in a faster maximum frame rate. As a consequence there are minor column artifacts (of very low DN) which are typically of no significance and irrelevant for many imaging systems. Note that these column artifacts will become more prominent as sensor gain is increased.

The image below shows a “dark” capture with Fast Readout Mode enabled and analog gain set to maximum (8x). The artifacts will become visible as fixed pattern DN column variations near the left edge of the video frame. There are darker columns followed by lighter columns as marked by the overlay graphics. These DN variations are not random columns, but consistent between individual OnSemi sensors operating in Fast Readout mode with high gain.

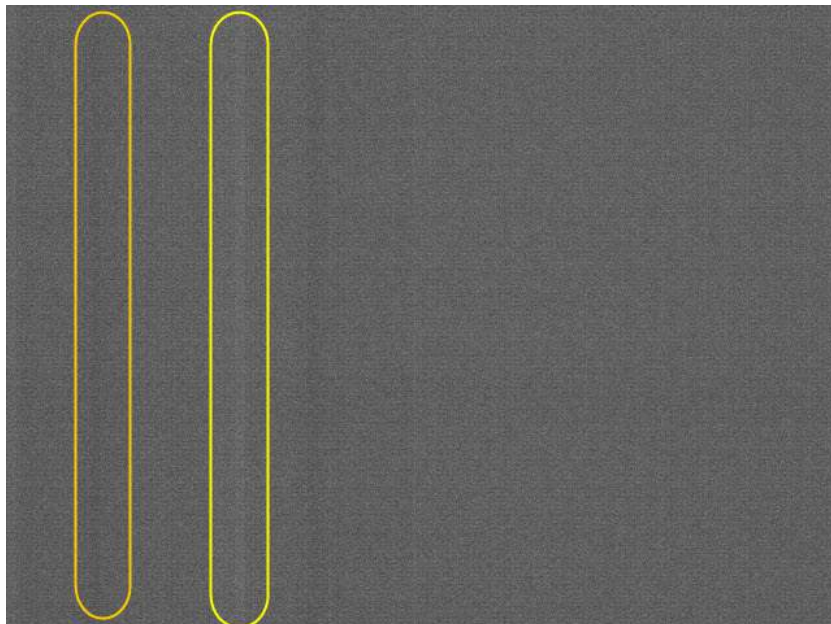

Fast Readout Mode Artifacts Correction

With all Nano OnSemi sensor models: A simple software host based “Flat Line” correction available with Spera LT, can be used to eliminate this Fast Readout Mode artifact. Users can test this with the Spera CamExpert tool. Refer to the manual (**Spera Getting Started – Cameras**) for instructions in calibrating and using the software based Flat Line correction.

With specifically the NanoXL models: Enable the camera based Flat Line features as described in the [Flat Field Correction Category](#).

Alternatively for **maximum acquisition quality**, disable Fast Readout Mode to eliminate acquisition DN variances, at a small reduction of the maximum frame rate. Also remember that high gain settings will increase overall sensor noise therefore additional gain should be used only as necessary.

Exposure Alignment: Overview

Exposure Control modes define the method and timing of controlling the sensor integration period. The integration period is the amount of time the sensor is exposed to incoming light before the video frame data is transmitted to the controlling computer.

- Exposure control is defined as the start of exposure and exposure duration.
- The feature **Exposure Mode** selects the controlling method for the exposure.
- The start of exposure is initiated by an internal timer signal, an external input trigger signal (Trigger Mode=ON), or a software function call.
- The exposure duration can be programmable (Exposure Mode = Timed, *free run or external trigger*) or controlled by the external input trigger pulse width (Exposure Mode = TriggerWidth).

Note that different Nano models will support different combinations of exposure controls.

See also [Trigger Overlap: Feature Details](#).

Synchronous Exposure Alignment

Exposure is synchronous to the internal timing of the sensor. The readout is concurrent to the exposure for the fastest possible frame rate.

When a valid trigger is received and the Exposure Time is shorter than the readout period, the Exposure Start event is latched in the previous frame's readout. That is; the Exposure Start Event is delayed and is initiated when the actual exposure starts such that the exposure ends and readout begins as soon as the previous readout has completed.

- For Sony sensor models the exposure is synchronous to the line timing of the sensor. The frame exposure start is subject to 1 horizontal line jitter.
- Sony sensors also add an extra two line-time at the end of exposure. For short very exposures the starting jitter and ending extension will be significant.
- The programmable exposure duration is in 1 μ s steps.
- Exposure duration is from a camera sensor specific minimum (in μ s) up to 16 sec.
- Any trigger received before the start of frame readout is ignored and generates an invalid frame trigger event.

Reset Exposure Alignment

Sensor timing is reset to initiate exposure when a valid trigger is received. Readout is sequential to exposure, reducing the maximum achievable frame rates. That is, a trigger received during exposure or readout is ignored since data would be lost by performing a reset.

Sensor Exposure Timing: Sony Sensor Models

Nano cameras with Sony sensors have general timing characteristics using *synchronous exposure* mode, as described below.

Trigger Characteristics: Start of Exposure

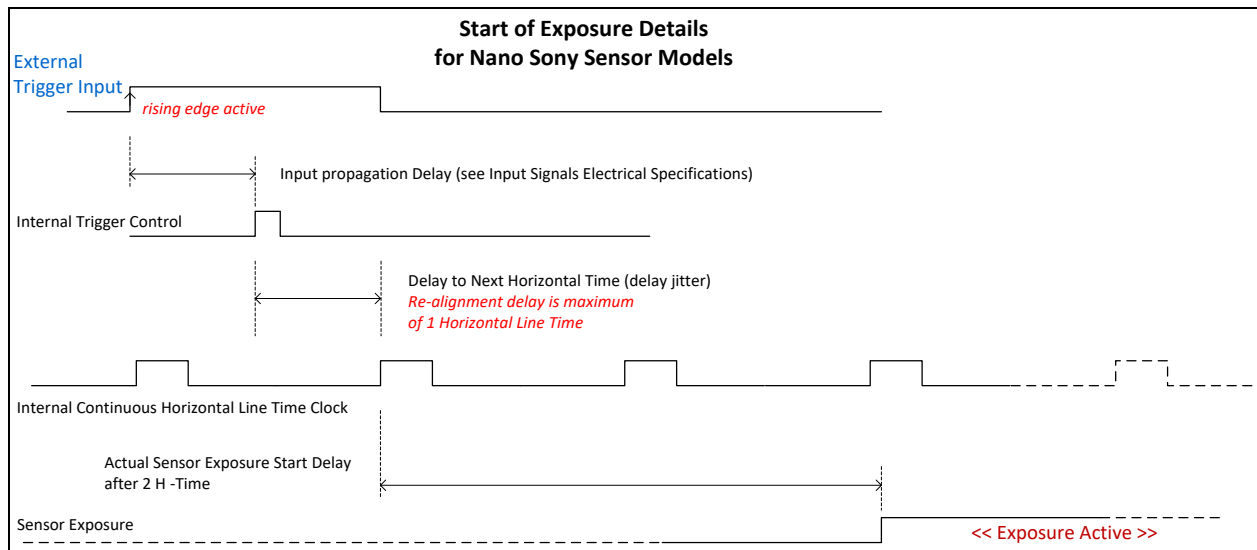

Additional triggered exposure mode features and timing are described in the [I/O Controls Category](#).

Refer to [Model Part Numbers](#) for the available Nano models using Sony sensors and their timing specifications.

Sensor Exposure Timing: OnSemi Python Models

Nano cameras with OnSemi sensors have general timing characteristics as described below.

Trigger Characteristics: Start of Exposure

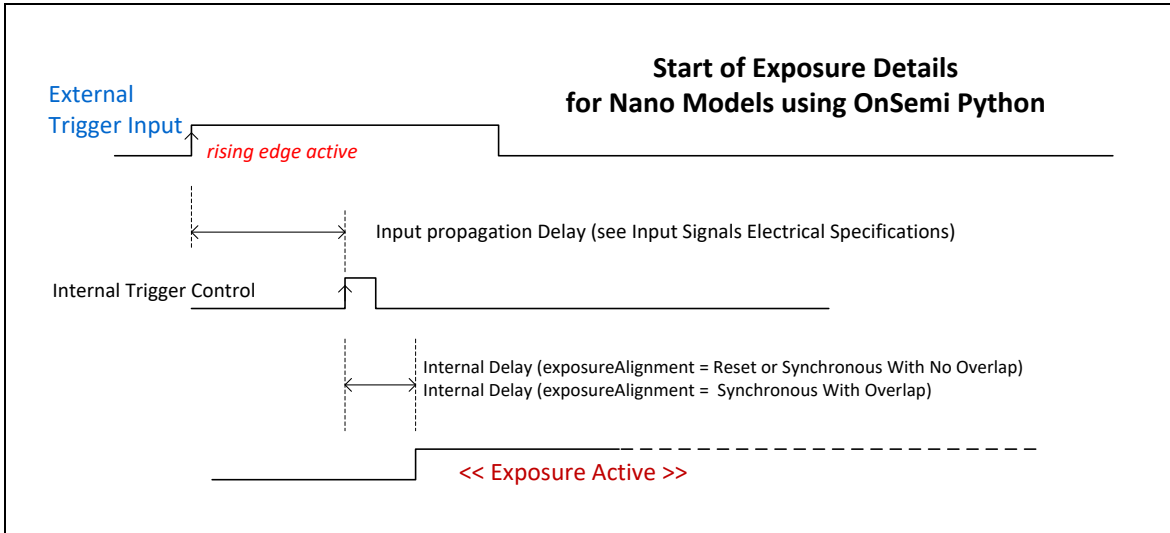

Additional triggered exposure mode features and timing specific to OnSemi sensors are described in the [I/O Controls Category](#).

See sections, Model Specifications: M/C640, M/C800, M/C1280, M/C1930, M/C2590 for specific timing values.

Auto-Brightness Control Category

The Genie Nano Auto-Brightness controls, as shown by CamExpert as a sub group to Sensor Controls, has features used to configure the automatic gain function. Parameters in gray are read only, either always or due to another parameter being disabled. Parameters in black are user set in CamExpert or programmable via an imaging application.

Features listed in the description table but tagged as *Invisible* are usually for Teledyne DALSA or third party software usage—not typically needed by end user applications. Also important, Genie Nano cameras are available in a number of models implementing different sensors which may support different features or none from this category.

Category	Parameter	Value
Camera Information	Auto-Brightness Mode	Active
<input checked="" type="checkbox"/> Sensor Control	Auto-Brightness Sequence	Exposure \ Gain
Auto-Brightness	Auto-Brightness Target Source	Raw Bayer Pattern
I/O Controls	Auto-Brightness Target	128
Counter And Timer Control	Auto-Brightness Target Variation	16
<input checked="" type="checkbox"/> Advanced Processing	Auto-Brightness Algorithm	Average
Cycling Preset	Auto-Brightness Minimum Time Activation	0.0
Image Format Controls	Auto-Brightness Convergence Time	2.0
<input checked="" type="checkbox"/> Metadata Controls	Auto-Exposure	Continuous
Acquisition and Transfer Cont...	Auto-Exposure Time Min Value	500.0
Action Control	Auto-Exposure Time Max Value	30000.0
<input checked="" type="checkbox"/> Event Control	Automatic Gain Control	Continuous
GigE Vision Transport Layer	Auto-Gain Source	Digital
File Access Control	Auto-Gain Max Value	4.0
GigE Vision Host Controls	Auto-Gain Min Value	1.0
	<< Less	

Auto-Brightness Feature Descriptions

The following table describes these features along with their view attribute and device version. For each feature the device version may differ for different camera sensors as they become available.

When a Device Version number is indicated, this represents the camera software functional group, not a firmware revision number. As Genie Nano capabilities evolve the device version will increase, therefore identifying the supported function package. New features for a major device version release will be indicated by **green text** for easy identification.

Features are common for all Nano models unless indicated otherwise. Additionally the description column will indicate which feature is a member of the DALSA Features Naming Convention (indicated by DFNC), versus the GenICam Standard Features Naming Convention (SFNC tag is not shown).

Note: Auto-Brightness not supported with model C4900 (18M Rolling Shutter).

Display Name	Feature & Values	Description	Device Version
Auto-Brightness Mode	autoBrightnessMode	Sets the mode for the Auto-Brightness function.	1.04 Expert DFNC
<i>Off</i>	<i>Off</i>	<i>Disable the auto-brightness mode.</i>	
<i>Active</i>	<i>Active</i>	<i>Activates the auto-brightness mode when the AcquisitionStart or AcquisitionArm command is received.</i>	
Auto-Brightness Sequence	autoBrightnessSequence	Specifies the processing order for the auto-brightness algorithm. Gain and Exposure are adjusted sequentially, in the selected order, to achieve the auto-brightness target value. If the Gain or Exposure features are not available or disabled, that feature is ignored in the processing sequence. < DFNC Expert >	1.04 Expert DFNC
<i>Exposure \ Gain</i>	<i>Exposure_Gain_Iris</i>	<i>Adjust Exposure, Gain, in that order to achieve the auto-brightness target value.</i>	
<i>Gain \ Exposure</i>	<i>Gain_Exposure_Iris</i>	<i>Adjust Gain, Exposure, in that order, to achieve the auto-brightness target value.</i>	
Auto-Brightness Target Source	autoBrightnessTargetSource	Specifies the source image color plane(s) used by the Auto-Brightness algorithm to determine the brightness adjustment required to obtain the auto-brightness target value.	1.04 Expert DFNC
<i>Luminance</i>	<i>Luminance</i>	<i>The luminance or Y component of the image is used as the auto-brightness target source.</i>	
<i>Raw Bayer Pattern</i>	<i>RawBayerPattern</i>	<i>The Raw Bayer Pattern of the image is used as the auto-brightness target source.</i>	
Auto-Brightness Target	autoBrightnessTarget	Sets the target image grayscale value, in DN, for the auto-brightness algorithm. Features that use auto-brightness include ExposureAuto, and GainAuto.	1.04 Expert DFNC
Auto-Brightness Target Variation	autoBrightnessTargetRangeVariation	Sets the auto-brightness target Range Variation in (DN). An autoBrightnessTarget value within this range is considered valid and will not be compensated.	1.04 Expert DFNC
Auto-Brightness Algorithm	autoBrightnessAlgorithm	Specifies the auto-brightness algorithm used to calculate the brightness in the target image source plane(s).	1.04 Expert DFNC
<i>Average</i>	<i>Average</i>	<i>The auto-brightness algorithm calculates the average luminance from the camera image and determines if the brightness should increase or decrease based on the requested target brightness.</i>	
Auto-Brightness Minimum Time Activation	autoBrightnessAlgoMinTimeActivation	Specifies the time delay between an image brightness change from the autoBrightnessTarget and when compensation of Gain/Exposure starts. This eliminates repetitive adjustments of short term brightness variations.	1.04 Expert DFNC
Auto-Brightness Convergence Time	autoBrightnessAlgoConvergenceTime	Specifies the maximum time the autoBrightnessAlgorithm should take to compensate the image brightness as defined by the autoBrightnessTarget. Actual times typically are less but may on occasion be more.	1.04 Expert DFNC
Auto-Exposure	ExposureAuto	Sets the automatic exposure mode when the ExposureMode feature is set to Timed.	1.04 Expert
<i>Off</i>	<i>Off</i>	<i>Exposure duration is manually controlled using the ExposureTime feature.</i>	
<i>Continuous</i>	<i>Continuous</i>	<i>Exposure duration is constantly adapted by the camera to meet the auto-brightness target pixel value.</i>	

Auto-Exposure Time Min Value	exposureAutoMinValue	Sets the minimum exposure time value allowed by the user, in microseconds, for the Auto-Exposure function.	1.04 Expert DFNC
Auto-Exposure Time Max Value	exposureAutoMaxValue	Sets the maximum exposure time value allowed by the user, in microseconds, for the Auto-Exposure function.	1.04 Expert DFNC
Automatic Gain Control	GainAuto	Controls the state of the automatic gain control.	1.04 Expert
<i>Off</i>	<i>Off</i>	<i>Gain is manually controlled using the Gain feature.</i>	
<i>Continuous</i>	<i>Continuous</i>	<i>Gain is constantly adjusted by the camera to meet the auto-brightness target pixel value. The initial starting gain can be set by setting GainAuto to Off, changing the gain value and then setting it back to Continuous.</i>	
Auto-Gain Source	gainAutoSource	Selects the gain to control.	1.06 Expert
<i>Digital</i>	<i>DigitalAll</i>	<i>Digital</i>	
<i>Sensor</i>	<i>SensorAll</i>	<i>Sensor (available in some models)</i>	
Auto-Gain Max Value	gainAutoMaxValue	Sets the maximum gain multiplier value for the automatic gain algorithm. The automatic gain function is an amplification factor applied to the video signal to obtain the auto-brightness target value.	1.04 Expert DFNC
Auto-Gain Min Value	gainAutoMinValue	Sets the minimum gain multiplier value for the automatic gain algorithm. The automatic gain function is an amplification factor applied to the video signal to obtain the auto-brightness target value.	1.04 Expert DFNC
Auto-Brightness Algorithm Source	autoBrightnessAlgoSource	Specifies the source location of the Auto-Brightness algorithm.	1.04 Invisible DFNC
<i>Local</i>	<i>Local</i>	<i>The auto-brightness algorithm runs in the camera.</i>	
<i>Ethernet</i>	<i>Host</i>	<i>The auto-brightness algorithm runs on a host machine via the Ethernet connection.</i>	

Using Auto-Brightness

The Auto-Brightness features are designed to maintain consistent brightness (or image intensity) in situations where lighting varies. These features benefit from being optimized for each applications lighting. The information below describes making these adjustments and the feature interdependencies. All feature example settings and acquisitions examples below are made using the Spera CamExpert tool.

Important: Setup is critical. The Auto-Brightness algorithm cannot converge unless control features are set properly (as required by the imaging situation). The following cases describe simple setups and the control feature considerations required to make them work.

General Preparation

- Before using any controls, a simple setup for experimentation is to have a reasonable free running acquisition of n-frames per second (*AcquisitionFrameRate*) and an exposure time (*ExposureTime*) that provides a viewable image.
- Take note of the frame rate and exposure time. If the frame rate is very slow due to a long exposure, add analog gain (*GainSelector* and *Gain*) and adjust the exposure time again.
- Enable all Auto-Brightness features by setting *autoBrightnessMode* to active (live acquisition must be off). This master feature only activates the auto-brightness, auto-exposure, and auto-gain controls but doesn't enable the processing.

- The features *autoBrightnessSequence*, *autoBrightnessTargetSource*, *autoBrightnessTarget*, *autoBrightnessTargetRangeVariation*, and *autoBrightnessAlgorithm* can remain at their default settings for this demo.
- Note that the *Auto-Brightness* function is not available if "Cycling Mode" is active.

The Auto-Brightness examples below are summarized as follows:

- Auto-Brightness by Frame Luminance Averaging
- Auto-Brightness by Adjusting a Digital Gain
- Auto-Brightness by Adjusting both Gain and Exposure

Auto-Brightness with Frame Luminance Averaging

After the preparations described above, the Auto-Exposure function is tested as follows. These setup steps are made before doing a live acquisition.

- Set the *autoBrightnessAlgoConvergenceTime* to a larger value than the default 2 seconds if more time is required to ensure adequate time for convergence.
- Set *ExposureAuto* to Continuous to activate all Auto-exposure features.
- Referring to the *ExposureTime* value used to get a viewable image during the free-running preparation stage, set *exposureAutoMaxValue* to a maximum exposure time longer than was needed. This maximum exposure limit feature may be required in imaging situations where the frame rate must not be forced below some minimum value. Also check that *exposureAutoMinValue* is low enough to allow the auto exposure a wide range to function in (but not too low else the algorithm will undershoot).
- Enable live acquisition (Grab button in CamExpert). The image exposure will adjust itself until the *autoBrightnessTarget* value is achieved. During live acquisition, the *autoBrightnessTarget* value can be changed to observe the algorithm converge to the new luminance value.
- Stop live acquisition (Freeze button in CamExpert). The feature *ExposureTime* is updated with the last exposure time used by the auto exposure algorithm. Adjust frame rate and analog gain settings as required to test again. Adjust other features mentioned as required.

Auto-Gain

An alternative method of automating exposure control is by varying the Nano Digital Gain. The user needs to note that the digital gain stage is limited to a small positive multiplier and will have the side effect of increasing digital noise.

- Setup will be similar to using auto exposure alone.
- Enable automatic digital gain by setting the feature *GainAuto* to Continuous.
- Limit the total digital gain range by adjusting the values for *gainAutoMaxValue* and *gainAutoMinValue*.

Auto-Brightness by using Auto-Exposure and Auto-Gain

- Use both *ExposureAuto* and *GainAuto* together to maximize the range of the Auto-Brightness range.
- Use *autoBrightnessSequence* to select the order of automation.
- Caution: Even with both automatic functions enabled, exposure convergence to a target value requires proper setup.

I/O Control Category

The Genie Nano I/O controls, as shown by CamExpert, has features used to configure external inputs and acquisition actions based on those inputs, plus camera output signals to other devices. Parameters in gray are read only, either always or due to another parameter being disabled. Parameters in black are user set in CamExpert or programmable via an imaging application.

Features listed in the description table but tagged as *Invisible* are usually for Teledyne DALSA or third party software usage—not typically needed by end user applications. Also important, Genie Nano cameras are available in a number of models implementing different sensors which may support different features within this category.

Category	Parameter	Value
Camera Information	Trigger Selector	Single Frame Trigger(Start)
<input checked="" type="checkbox"/> Sensor Control	Trigger Mode	On
Auto-Brightness	Trigger Frames Count	Not Enabled
I/O Controls	Software Trigger	Press...
Counter And Timer Control	Trigger Source	Line 1
<input checked="" type="checkbox"/> Advanced Processing	Trigger Input Line Activation	Rising Edge
Color Processing	Trigger Overlap	Readout
Cycling Preset	Trigger Delay	0.0
Image Format Controls	Line Selector	Line 3
<input checked="" type="checkbox"/> Metadata Controls	Line Name	Output 1
Chunk Parser	Line Format	Opto-Coupled
Acquisition and Transfer Control	Line Mode	Output
Action Control	Line Status	False
<input checked="" type="checkbox"/> Event Control	Line Inverter	False
GigE Vision Transport Layer	Input Line Detection Level	Not Enabled
File Access Control	Input Line Debouncing Period	Not Enabled
GigE Vision Host Controls	Output Line Source	Pulse on: Input 2 Event
	Output Line Pulse Signal Activation	Rising Edge
	Output Line Pulse Delay	0
	Output Line Pulse Duration	1
	Output Line Value	Not Enabled
	Output Line Software Latch Control	Off
	Line Status All	0x0000000000000000
	Output Line Software Command	0
	<< Less	

I/O Control Feature Descriptions

The following table describes these features along with their view attribute and minimum camera firmware version required. Additionally the Device Version column will indicate which parameter is a member of the DALSA Features Naming Convention (indicated by DFNC), versus the GenICam Standard Features Naming Convention (SFNC tag is not shown).

The Device Version number represents the camera software functional group, not a firmware revision number. As Genie Nano capabilities evolve the device version tag will increase, therefore identifying the supported function package. New features for a major device version release will be indicated by **green text** for easy identification.

Display Name	Feature & Values	Description	Device Version & View
Trigger Selector	TriggerSelector	Selects which type of trigger to configure with the various Trigger features.	1.00 Beginner
Single Frame Trigger(Start)	FrameStart	Selects a trigger starting the capture of a single frame. Frame size is determined by image format feature "Height".	
MultiFrame Trigger(Start)	FrameBurstStart	Selects a trigger to capture multiple frames. The number of frames is specified by the "triggerFrameCount" feature.	
AcquisitionStart Trigger(Start)	AcquisitionStart	Enables the selection of a trigger source that starts the Acquisition of one or many frames. (Ver. 1.05)	
Trigger Mode	TriggerMode	Controls the enable state of the selected trigger.	1.00 Beginner
Off	Off	The selected trigger is turned off.	
On	On	The selected trigger is turned active.	
Trigger Frames Count	triggerFrameCount	Sets the total number of frames to acquire when a valid trigger is received. This feature is available when Trigger Selector = MultiFrame Trigger(Start).	1.00 DFNC Beginner
Software Trigger	TriggerSoftware	Generate a software command internal trigger immediately no matter what the TriggerSource feature is set to.	1.00 Beginner
Trigger Source	TriggerSource	Specifies the internal signal or physical input line to use as the trigger source. The selected trigger must have its TriggerMode set to ON. See Input Signals Electrical Specifications.	1.00 Beginner
Line 1	Line1	Select Line 1 (and associated I/O control block) to use as the external trigger source. See LineSelector feature for complete list.	
Line 2	Line2	Select Line 2 (and associated I/O control block) to use as the external trigger source. See LineSelector feature for complete list.	
Software	Software	The trigger command source is only generated by software using the Trigger Software command.	
Action 1	Action1	Select the GigEVision Action Command 1 as the internal trigger source. This is a broadcast command that multiple devices can respond to simultaneously. (Ver. 1.03)	
Action 2	Action2	Select the GigEVision Action Command 2 as the internal trigger source. This is a broadcast command that multiple devices can respond to simultaneously. (Ver. 1.05)	
Timestamp Modulo Event	timestampModuloEvent	Select the timestamp modulo event as the internal trigger source. (Ver. 1.03)	
Timer1End Event	Timer1End	Select the TimerEnd Event as the internal trigger source.	

<i>Counter1End Event</i>	<i>Counter1End</i>	Select the CounterEnd Event as the internal trigger source.	
Trigger Input Line Activation	TriggerActivation	Select the activation mode for the selected Input Line trigger source. This is applicable only for external line inputs.	1.00 Beginner
<i>Rising Edge</i>	<i>RisingEdge</i>	The trigger is considered valid on the rising edge of the line source signal (after any processing by the line inverter module).	
<i>Falling Edge</i>	<i>FallingEdge</i>	The trigger is considered valid on the falling edge of the line source signal (after any processing by the line inverter module).	
<i>Any Edge</i>	<i>AnyEdge</i>	The trigger is considered valid on any edge of the line source signal (after any processing by the line inverter module).	
<i>Level High</i>	<i>LevelHigh</i>	The trigger is considered valid on the high level of the line source signal.	
<i>Level Low</i>	<i>LevelLow</i>	The trigger is considered valid on the low level of the line source signal.	
Trigger Delay	TriggerDelay	Specifies the delay in microseconds to apply after receiving the trigger and before activating the triggerEvent. (min=0, max=2000000)	1.00 Beginner
Trigger Overlap	TriggerOverlap	States if a trigger overlap is permitted with the Active Frame readout signal. This feature defines if a new valid trigger will be accepted (or latched) for a new frame.	1.00 Guru
<i>Off</i>	<i>Off</i>	No trigger overlap is permitted.	
<i>ReadOut</i>	<i>ReadOut</i>	Trigger is accepted immediately after the start of the readout.	
<i>End Of Exposure</i>	<i>EndOfExposure</i>	Trigger is accepted immediately after the previous exposure period. This will latch the Trigger and delay the Exposure if the end of that exposure is shorter than the previous readout.	
Line Selector	LineSelector	Selects the physical line (or pin) of the external device connector to configure.	1.00 Beginner
<i>Line 1</i>	<i>Line1</i>	Index of the physical line and associated I/O control block to use. Pin 5 is the Input Signal and Pin 3 is the common Ground on the I/O connector.	
<i>Line 2</i>	<i>Line2</i>	Index of the physical line and associated I/O control block to use. Pin 7 is the Input Signal and Pin 3 is the common Ground on the I/O connector.	
<i>Line 3</i>	<i>Line3</i>	Index of the physical line and associated I/O control block to use. Pin 6 is the Output Signal and Pin 4 is the common output power on the I/O connector.	
<i>Line 4</i>	<i>Line4</i>	Index of the physical line and associated I/O control block to use. Pin 8 is the Output Signal and Pin 4 is the common output power on the I/O connector.	
<i>Line 5</i>	<i>Line5</i>	(Optional Model – see Output3 below) Index of the physical line and associated I/O control block to use. Pin 9 is the Output Signal and Pin 4 is the common output power on the I/O connector.	
Line Name	lineName	Description of the physical Pin associated with the logical line.	1.00 Beginner DFNC
<i>Input 1</i> <i>Input 2</i>	<i>Input1</i> <i>Input2</i>	Associated with the logical line Input 1 Associated with the logical line Input 2 * "G3-GM2... or G3-GC2..." part numbers denote optional "1 input / 3 output" special order models.	
<i>Output 1</i> <i>Output 2</i> <i>Output 3</i>	<i>Output1</i> <i>Output2</i> <i>Output3</i>	Associated with the logical line Output 1 Associated with the logical line Output 2 * "G3-GM2... or G3-GC2..." part numbers denote optional "1 input / 3 output" special order models.	

Line Format	LineFormat	Specify the current electrical format of the selected physical input or output. (RO)	1.00 Expert
<i>Opto-Coupled</i>	<i>OptoCoupled</i>	<i>The line is opto-Coupled.</i>	
Line Mode	LineMode	Reports if the physical Line is an Input or Output signal. (RO) See Input Signals Electrical Specifications. See Output Signals Electrical Specifications.	1.00 Expert
<i>Input</i>	<i>Input</i>	<i>The line is an input line.</i>	
<i>Output</i>	<i>Output</i>	<i>The line is an output line.</i>	
Line Status	LineStatus	Returns the current status of the selected input or output line.	1.00 Expert
	<i>False</i>	<i>The Line is logic LOW</i>	
	<i>True</i>	<i>The Line is logic HIGH</i>	
Line Status All	LineStatusAll	Returns the current status of all available line signals, at time of polling, in a single bitfield. The order is Line1, Line2, Line3, ...	1.00 Expert
Line Inverter	LineInverter	Control to invert the polarity of the selected input or output line signal.	1.00 Beginner
	<i>False / True</i>		
Input Line Detection Level	lineDetectionLevel	Specifies the voltage threshold required to recognize a signal transition on an input line.	1.00 Beginner DFNC
<i>Threshold for TTL</i>	<i>Threshold_for_TTL</i>	<i>A signal below 0.8V will be detected as a Logical LOW and a signal greater than 2.4V will be detected as a Logical HIGH on the selected input line.</i>	
Input Line Debouncing Period	lineDebouncingPeriod	Specifies the minimum delay before an input line voltage transition is recognizing as a signal transition.	1.00 Beginner DFNC
Output Line Source	outputLineSource	Selects which internal signal or event driven pulse or software control state to output on the selected line. Note, the LineMode feature must be set to Output. The List of supported output line sources is product-specific. The Event Control section provides details and timing diagrams for the supported trigger modes.	1.00 Beginner DFNC
<i>Off</i>	<i>Off</i>	<i>Line output is Open</i>	
<i>Software Controlled</i>	<i>SoftwareControlled</i>	<i>The OutputLineValue feature changes the state of the output</i>	
<i>Pulse on: Start of Frame</i>	<i>PulseOnStartofFrame</i>	<i>Generate a pulse on the start of the Frame Active event</i>	
<i>Pulse on: Start of Exposure</i>	<i>PulseOnStartofExposure</i>	<i>Generate a pulse on the ExposureStart event. This option is typically used to trigger a strobe light.</i>	
<i>Pulse on: End of Exposure</i>	<i>PulseOnEndofExposure</i>	<i>Generate a pulse on the ExposureEnd event. This option is typically used to trigger a strobe light. (N/A for C4900 – 1.06)</i>	
<i>Pulse on: Start of Readout</i>	<i>PulseOnStartofReadout</i>	<i>Generate a pulse on the ReadoutStart event.</i>	
<i>Pulse on: End of Readout</i>	<i>PulseOnEndofReadout</i>	<i>Generate a pulse on the ReadoutEnd event.</i>	
<i>Pulse on: Valid Frame Trigger</i>	<i>PulseOnValidFrameTrigger</i>	<i>Generate a pulse on the ValidFrameTrigger event.</i>	
<i>Pulse on: Rejected Frame(s) Trigger</i>	<i>PulseOnInvalidFrameTrigger</i>	<i>Generate a pulse on the InvalidFrameTrigger event.</i>	
<i>Pulse on: Start of Acquisition</i>	<i>PulseOnStartofAcquisition</i>	<i>Generate a pulse when the AcquisitionStart event occurs.</i>	
<i>Pulse on: End of Acquisition</i>	<i>PulseOnEndofAcquisition</i>	<i>Generate a pulse when the AcquisitionStop event occurs.</i>	
<i>Pulse on: End of Timer 1</i>	<i>PulseOnEndofTimer1</i>	<i>Generate a pulse on the TimerEnd 1 event.</i>	
<i>Pulse on: End of Counter 1</i>	<i>PulseOnEndofCounter1</i>	<i>Generate a pulse on the CounterEnd 1 event.</i>	
<i>Pulse on: Input 1 Event</i>	<i>PulseOnInput1</i>	<i>Generate a pulse on the Input signal 1 event</i>	
<i>Pulse on: Input 2 Event</i>	<i>PulseOnInput2</i>	<i>Generate a pulse on the Input signal 2 event</i>	

<i>Pulse on: Action 1</i>	<i>PulseOnAction1</i>	Generate a pulse on the GigEVision Action Command 1. (ver: 1.03)	
<i>Pulse on: Action 2</i>	<i>PulseOnAction2</i>	Generate a pulse on the GigEVision Action Command 2. (ver: 1.03)	
<i>Pulse on: Software Command</i>	<i>PulseOnSoftwareCmd</i>	Generate a pulse on the Input of a Software Command	
<i>Exposure Active</i>	<i>ExposureActive</i>	Generate a signal that is active when the Exposure is active. <from v1.01 > (N/A for C4900 – 1.06)	
Output Line Pulse Signal Activation	outputLinePulseActivation	Specifies the input line activation mode to trigger the OutputLine pulse.	1.00 Beginner DFNC
<i>Rising Edge</i>	<i>RisingEdge</i>	Specifies that the trigger is considered valid on the rising edge of the source signal.	
<i>Falling Edge</i>	<i>FallingEdge</i>	Specifies that the trigger is considered valid on the falling edge of the source signal.	
<i>Any Edge</i>	<i>AnyEdge</i>	Specifies that the trigger is considered valid on the falling or rising edge of the source signal.	
Output Line Pulse Delay	outputLinePulseDelay	Sets the delay (in μ s) before the output line pulse signal. Applicable for the OutputLineSource feature.	1.00 Beginner DFNC
Output Line Pulse Duration	outputLinePulseDuration	Sets the width (duration) of the output line pulse in microseconds.	1.00 Beginner DFNC
Output Line Value	outputLineValue	Sets the output state of the selected Line if the outputLineSoftwareLatchControl = OFF. OutputLineSource must be SoftwareControlled. If the outputLineSoftwareLatchControl = Latch , the state of the pin will change with the outputLineSoftwareCmd command.	1.00 Beginner DFNC
<i>Active</i>	<i>Active</i>	Sets the Output circuit to close	
<i>Inactive</i>	<i>Inactive</i>	Sets the Output circuit to open	
Output Line Software Latch Control	outputLineSoftwareLatchControl	When Off, the selected output line is set with the value in Output Line Value.	1.00 Guru DFNC
<i>Off</i>	<i>Off</i>	Output pin state set by outputLineValue.	
<i>Latch</i>	<i>Latch</i>	Output pin state set by outputLineSoftwareCmd.	
Flash Zone Delay	flashZoneDelay	Returns the recommended output pulse delay, corresponding to the delay of the last line exposure start of a rolling shutter sensor, when the Output Line Source = Pulse on Start of Exposure. (RO)	1.06 Guru DFNC Model C4900
Flash Zone Duration	flashZoneDuration	Returns the recommended output pulse duration for controlling a flash device for the optimal flash zone time. (RO)	1.06 Guru DFNC Model C4900
Output Line Software Command	outputLineSoftwareCmd	Writing a value of 1 in the bit field applies the Latch value of the outputLineSoftwareLatchControl and/or executes the PulseOnSoftwareCmd for any output line programmed for software control. The feature outputLineSoftwareCmd can take any binary value and each bit set to 1 corresponds to a lcommand for an Output. Note that Outputs are numbered from 1 to N, therefore Bit 1 of outputLineSoftwareCmd corresponds to Output1. This is applicable to OutputLineSource = Pulse On: where Software Cmd (for Pulse mode) or OutputLineSource = SoftwareControlled and OutputLineSoftwareLatchControl = Latch (for static states).	1.00 Expert DFNC
Line Pinout	linePinAssociation	Enumeration of the physical line (or pin) on the device I/O connector. (RO)	1.00 Invisible
<i>Pin5=Signal – Pin3=Gnd</i>	<i>Pin5Signal_Pin3Gnd</i>	Pin 5 is the Input Signal and Pin 3 is the common input Ground on the I/O connector.	
<i>Pin7=Signal – Pin3=Gnd</i>	<i>Pin7Signal_Pin3Gnd</i>	Pin 7 is the Input Signal and Pin 3 is the common input Ground on the I/O connector.	
<i>Pin6=Signal – Pin4=Pwr</i>	<i>Pin6Signal_Pin4Pwr</i>	Pin 6 is the Output Signal and Pin 4 is the common output Power on the device connector.	

Pin8=Signal – Pin4=Pwr	Pin8Signal_Pin4Pwr	Pin 8 is the Output2 Signal and Pin 4 is the common output Power on the device connector.
------------------------	--------------------	---

I/O Module Block Diagram

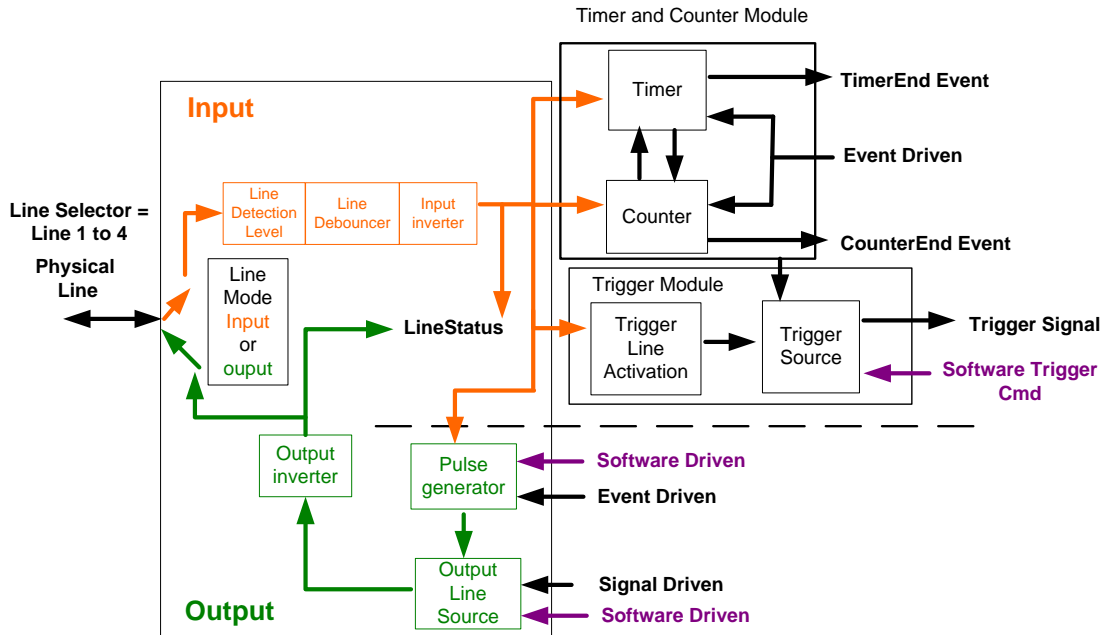

Trigger Mode Details

Genie Nano image exposures are initiated by an event. The trigger event is either the camera's programmable internal clock used in free running mode, an external input used for synchronizing exposures to external triggers, or a programmed function call message by the controlling computer. These triggering modes are described below.

- **Free running (Trigger Mode=Off):** The Nano free-running mode has programmable internal timers for frame rate and exposure period. Frame rate minimums, maximums, and increments supported are sensor specific. Maximum frame rates are dependent on the required exposure.
- **External trigger (Trigger Mode=On):** Exposures are controlled by an external trigger signal where the specific input line is selected by the **Trigger Source** feature. External signals are isolated by an opto-coupler input with a time programmable debounce circuit.

Trigger Source Types (Trigger Mode=On)

- **Trigger Source=Software:** An exposure trigger is sent as a control command via the Ethernet network connection. Software triggers cannot be considered time accurate due to network latency and sequential command jitter. But a software trigger is more responsive than calling a single-frame acquisition since the latter must validate the acquisition parameters and modify on-board buffer allocation if the buffer size has changed since the last acquisition.
- **Trigger Source = Line 1 or 2:** An external trigger signal is opto-coupled and subject to a signal debounce, input delay, plus inversion circuits.

- **Trigger Line Polarity:** For external line signals, a rising edge signal is suggested to minimize the time it takes for the opto-coupler to change state.
- **Trigger Source=Timer1End Event:** The Timer1 End Event is used as the internal trigger source. Refer to [Counter and Timer Controls](#) for information on those features.
- **Trigger Source=Counter1End Event:** The Counter1 End Event is used as the internal trigger source.

Input Line Details

The general purpose input line signals are connected to I/O lines 1 and 2, which have the following features for control or status indication.

- **Feature set:** LineSelector (RW), LineName (RO), linePinAssociation (RO), LineFormat (RO), LineMode (RO), lineDetectionLevel (RW), lineDebouncingPeriod (RW), LineInverter (RW), LineStatus (RO).
- **Connector:** See 10-pin I/O Connector Details for connector pinout and electrical information. The cable shell and shield should electrically connect the Genie Nano chassis to computer chassis for maximum EMI protection.
- **Line Transition Validation:** Each input incorporates a signal debounce circuit (following the opto-couple) to eliminate short noise transitions that could be wrongly interpreted as a valid pulse. The duration is user-programmable from 0 μ s to 255 μ s with CamExpert.
- **Line Signal Propagation & Timing:** Maximum delay values are defined in Input Signals Electrical Specifications.

Trigger Overlap: Feature Details

The Trigger Overlap feature defines how the Nano handles triggers that might occur more frequently than the Frame Active period (an exposure plus readout period).

If TriggerOverlap=OFF, then triggers received before the end of the Frame Active period are ignored. Other TriggerOverlap values are dependent on the Nano model and sensor used.

- **TriggerOverlap=Off**
- No trigger overlap is permitted.

Diagram Conditions:

- TriggerMode=On
- ExposureMode=Timed
- TriggerActivation=RisingEdge
- TriggerDelay=0
- TriggerSelector=FrameStart
- ExposureAlignment=Synchronous

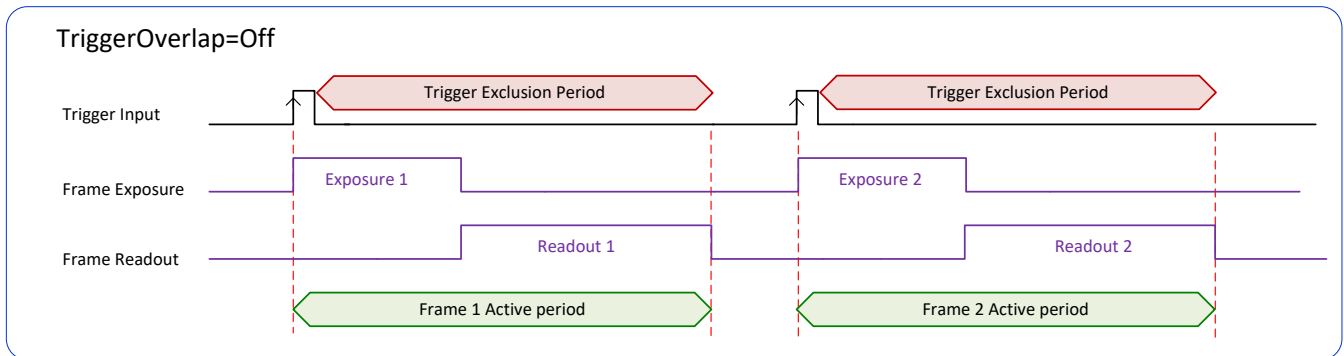

Timing specific to OnSemi models

- Minimum Trigger to Exposure start delay: $3.23\mu\text{s}$ (shown as $4\mu\text{s}$)
- Readout Time:
 - M/C2590: $23242\mu\text{s} + 16.5\mu\text{s}$
 - M/C1930: $10831\mu\text{s} + 16.5\mu\text{s}$
 - M/C1280: $5676\mu\text{s} + 16.5\mu\text{s}$
 - M/C800: $2332\mu\text{s} + 16.5\mu\text{s}$
 - M/C640: $1602\mu\text{s} + 16.5\mu\text{s}$

- **TriggerOverlap=ReadOut**
- Trigger is accepted at the beginning of the frame Readout. The “End of Exposure to Start of Readout” time is sensor dependent.

Diagram Conditions:

- TriggerMode=On
- ExposureMode=Timed
- TriggerActivation=RisingEdge
- TriggerDelay=0
- TriggerSelector=FrameStart
- ExposureAlignment=Synchronous

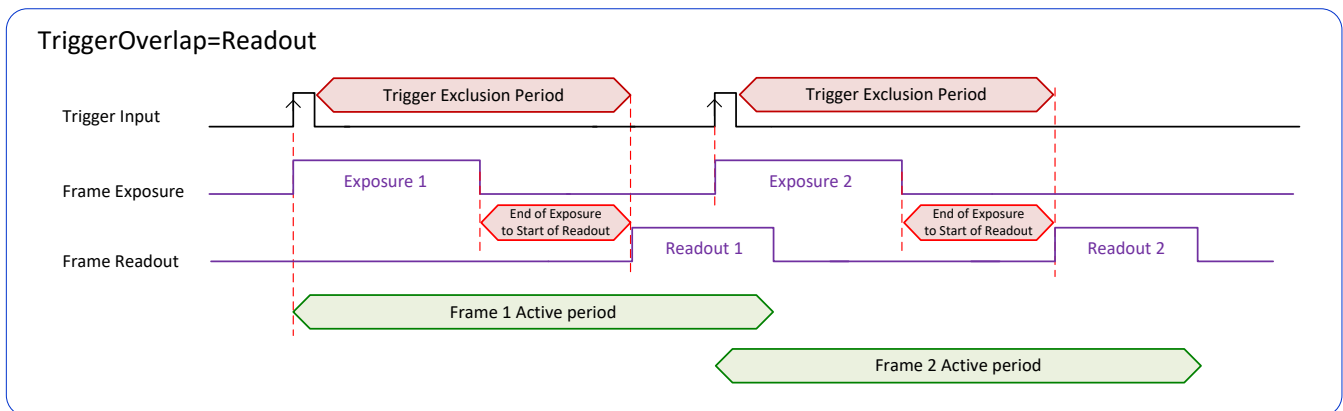

Timing specific to OnSemi models

- Trigger to Exposure start has a delay which includes the sensor readout time plus a minimum of 62µs. An exposure always starts after the readout of the previous frame.
- Trigger Delay Times (min. with normal ROT):
 - M/C2590: 23318µs
 - M/C1930: 10907µs
 - M/C1280: 5751µs
 - M/C800: 2407µs
 - M/C640: 1677µs

- **TriggerOverlap=EndOfExposure**

- Trigger is accepted immediately after the previous exposure period. This will latch the Trigger and delay the Exposure if the end of that exposure is shorter than the previous readout.

Diagram Conditions:

- TriggerMode=On
- ExposureMode=Timed
- TriggerActivation=RisingEdge
- TriggerDelay=0
- TriggerSelector=FrameStart
- ExposureAlignment=Synchronous

Applicable to current Sony sensor models

Sony sensor Nano models support a maximum trigger rate by allowing a trigger signal soon after the exposure period. A trigger is accepted and buffered for a 12 line clock period (after the exclusion period) at which the next exposure starts. As shown in the diagram below, the following exposure can be active even before the frame readout of the previous exposure.

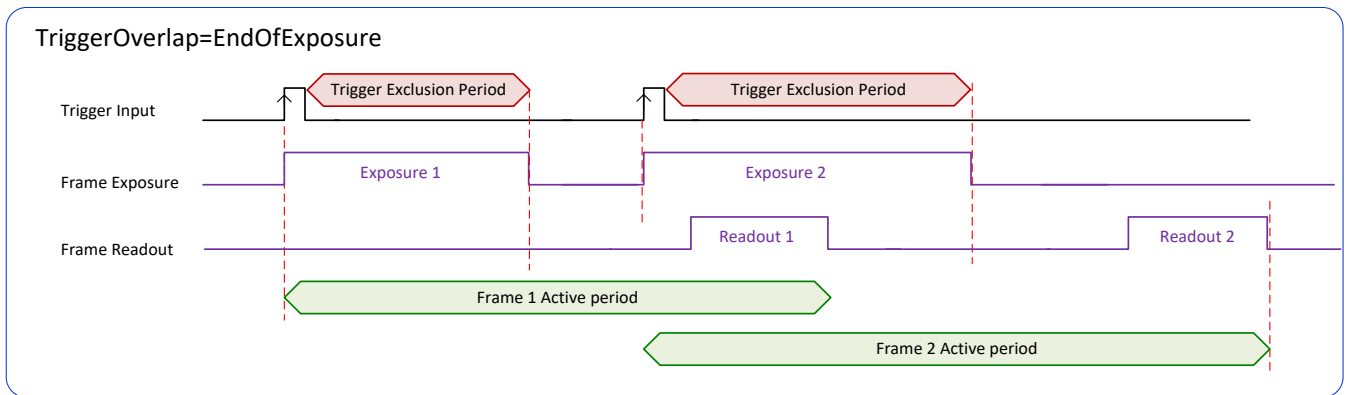

Refer to [Model Part Numbers](#) for the available Nano models using Sony sensors and their timing specifications.

- **TriggerOverlap= EndOfExposure or Readout**
- This special condition describes the case of a short exposure relative to the readout period. A trigger received before the end of the frame readout is latched and delayed until such time that the following short exposure will end with the end of the previous frame readout. The second readout period will then start immediately.

Diagram Conditions:

- TriggerMode=On
- ExposureMode=Timed
- TriggerActivation=RisingEdge
- TriggerDelay=0
- TriggerSelector=FrameStart
- ExposureAlignment=Synchronous

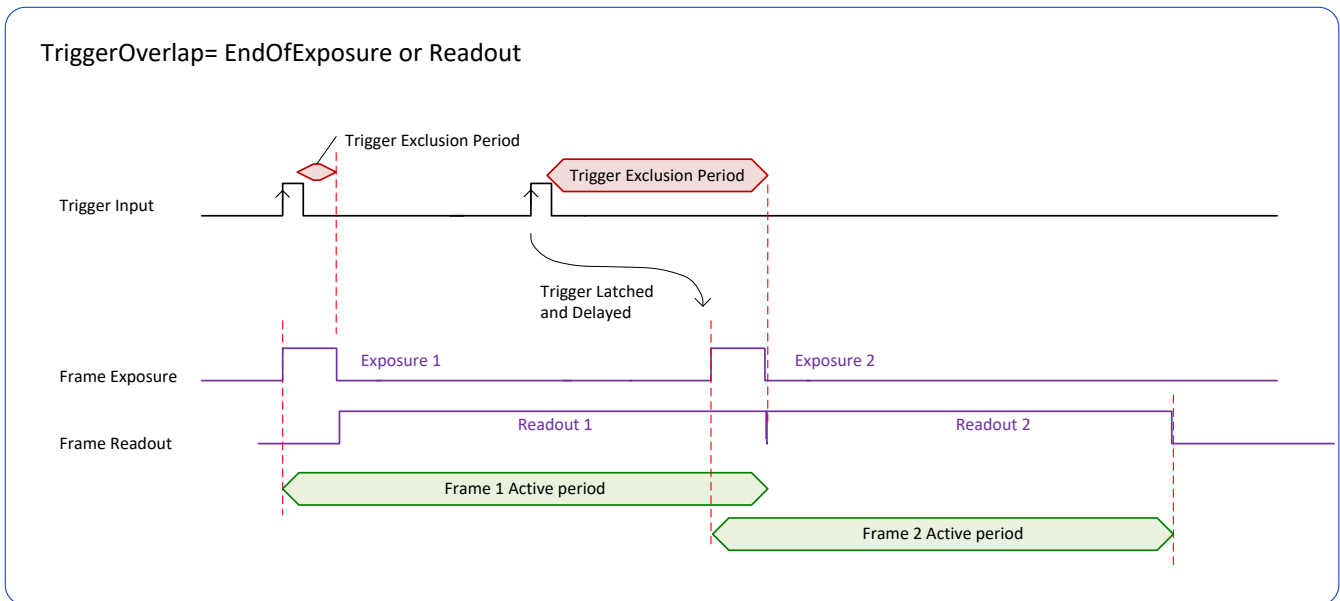

- **TriggerOverlap= Readout and ExposureMode=TriggerWidth**
- This special condition describes the case of a short TriggerWidth exposure relative to the readout period. If the next Trigger input signal occurs during the previous frame readout, attempting to stop the frame active period before the current readout is completed, the camera will continue the second exposure until the previous readout is completed. In this condition the actual exposure time is longer than the trigger input width.

Diagram Conditions (Sony Sensors):

- TriggerMode=On
- ExposureMode=TriggerWidth
- TriggerActivation=RisingEdge
- TriggerDelay=0
- TriggerSelector=FrameStart
- ExposureAlignment=Synchronous

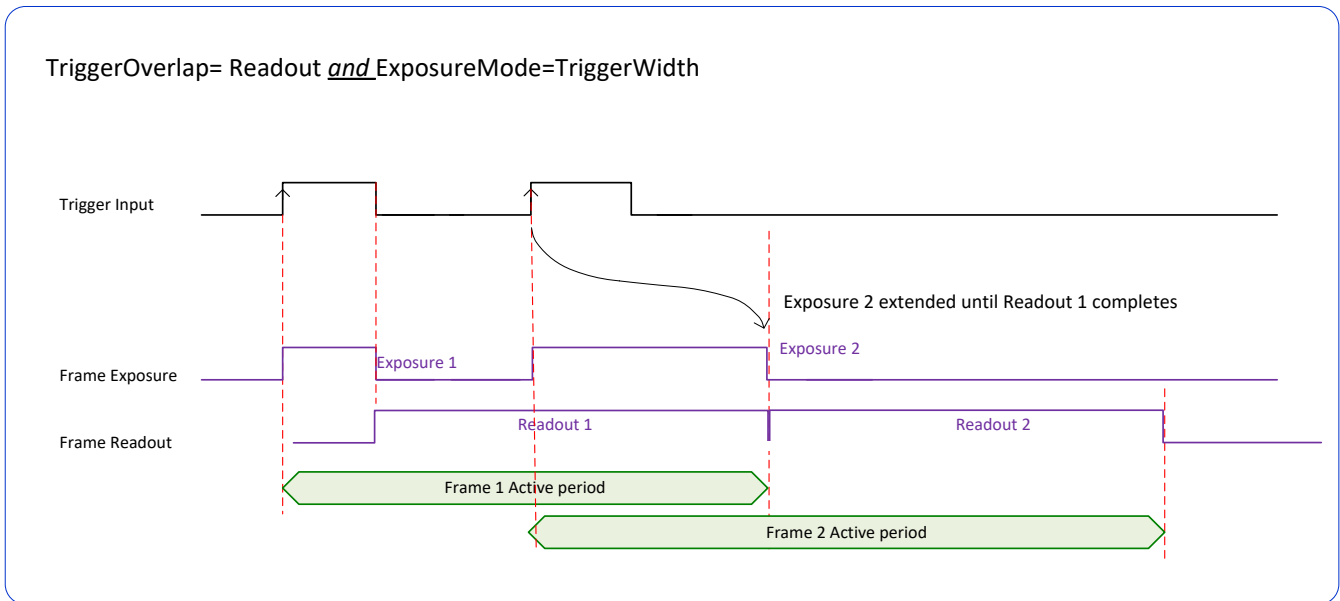
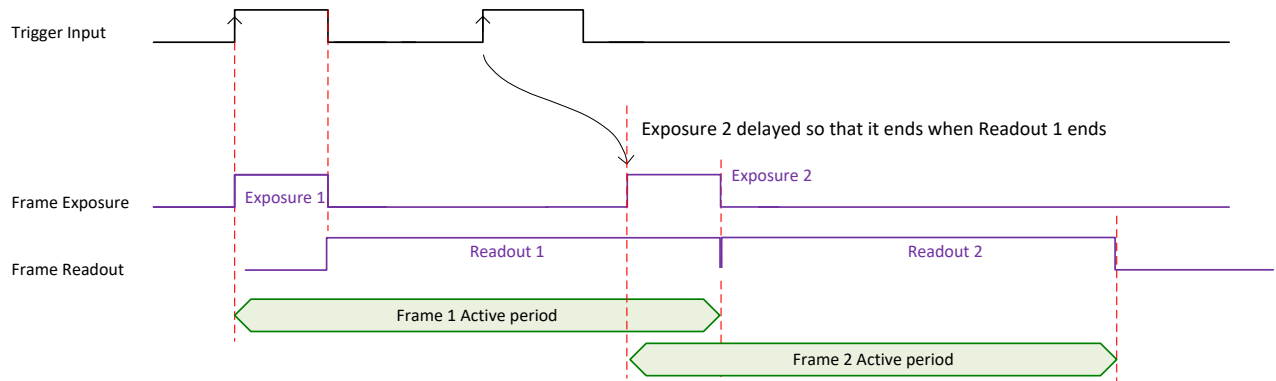

Diagram Conditions (OnSemi Sensors):

- TriggerMode=On
- ExposureMode=TriggerWidth
- TriggerActivation=RisingEdge
- TriggerDelay=0
- TriggerSelector=FrameStart
- ExposureAlignment=Synchronous

OnSemi Sensor TriggerOverlap= Readout and ExposureMode=TriggerWidth



- **TriggerOverlap=Off and ExposureMode=TriggerWidth**

Diagram Conditions:

- TriggerMode=On
- ExposureMode=TriggerWidth
- TriggerActivation=RisingEdge
- TriggerDelay=0
- TriggerSelector=FrameStart
- ExposureAlignment=Synchronous

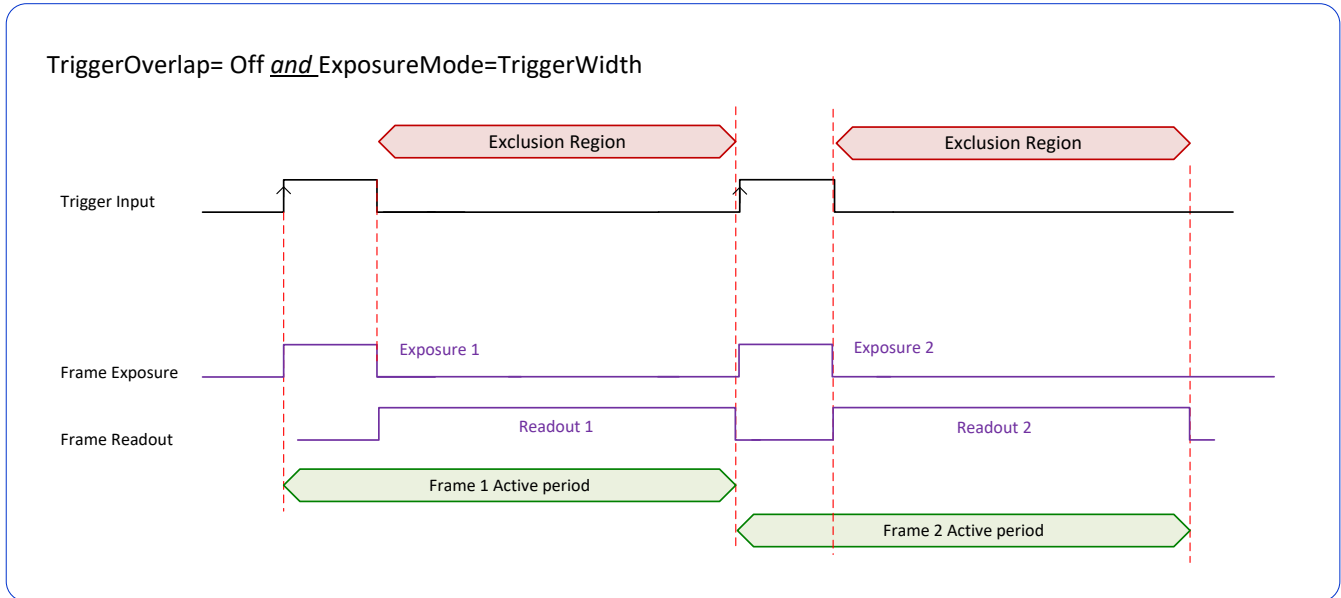

Output Line Details

The general purpose output line signals are connected to I/O lines 3 and 4, which have the following features for control or status indication.

- **Feature set:** LineInverter (RW), outputLineSource (RW), outputLinePulseDelay (RW), outputLinePulseDuration (RW), outputLineValue (RW), outputLineSoftwareCmd (RW), LineSelector (RW), LineName (RO), linePinAssociation (RO), LineFormat (RO), LineMode (RO), LineStatus (RO). See Output Signals Electrical Specifications for more information.
- **External outputs:** Can be used as a strobe signals to control lighting or to generate programmable pulses when specific events are generated by the camera.
- **Output on Events:** Each output can be set independently to one of the available event modes defined by the 'outputLineSource' feature.

Output High and Output Low Block Diagram

Output signal lines when either in the High or Low state are shown in the following figures with an simplified external circuit.

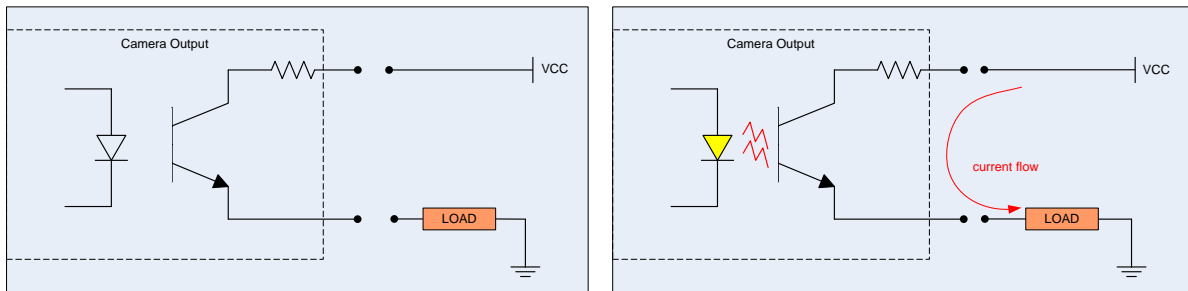

Examples of Logic HI and Logic LO output circuits

Counter and Timer Control Category

The Genie Nano counter and timer controls, as shown by CamExpert, has parameters used to configure acquisition counters and timers for various input lines and signal edge detection. Parameters in gray are read only, either always or due to another parameter being disabled. Parameters in black are user set in CamExpert or programmable via an imaging application.

Features listed in the description table but tagged as *Invisible* are usually for Teledyne DALSA or third party software usage—not typically needed by end user applications. Also important, Genie Nano cameras are available in a number of models implementing different sensors and image resolutions which may not support the full feature set defined in this category.

Category	Parameter	Value
Camera Information	Counter Selector	Counter 1
☐ Sensor Control	Counter mode	Off
Auto-Brightness	Counter Status	Counter Idle
I/O Controls	Counter Start Source	Line 1
Counter And Timer Control	Counter Start Line Activation	Rising Edge
☐ Advanced Processing	Counter Incremental Source	Internal Clock
Color Processing	Counter Incremental Line Activation	Not Enabled
Cycling Preset	Counter Reset Source	Reset Cmd
Image Format Controls	Counter Reset Input Line Activation	Not Enabled
☐ Metadata Controls	Counter Duration	1
Chunk Parser	Counter Value	0
Acquisition and Transfer Control	Counter Value At Reset	0
Action Control	Counter Reset	Not Enabled
☑ Event Control	Timer Selector	Timer 1
GigE Vision Transport Layer	Timer mode	Off
File Access Control	Timer Status	Timer Idle
GigE Vision Host Controls	Timer Start Source	Line 1
	Timer Line Activation	Rising Edge
	Timer Duration (in us)	1
	Timer Value	0
	Timer Reset	Not Enabled

Counter and Timer Control Feature Description

The following table and [block diagram](#), describes these parameters along with their view attribute and minimum camera firmware version required. Additionally the Device Version column will indicate which parameter is a member of the DALSA Features Naming Convention (indicated by DFNC), versus the GenICam Standard Features Naming Convention (SFNC tag is not shown).

The Device Version number represents the camera software functional group, not a firmware revision number. As Genie Nano capabilities evolve the device version tag will increase, therefore identifying the supported function package. New features for a major device version release will be indicated by **green text** for easy identification.

Display Name	Feature & Values	Description	Device Version & View
Counter Selector	counterSelector	Selects the counter to configure.	1.00 Expert DFNC
Counter 1	Counter1	Select counter 1	
Counter mode	counterMode	Selects the counter mode. The selected Counter is either Active or Disabled. When Disabled, the Counter can be configured.	1.00 Expert DFNC
Off	Off	The selected Counter is Disabled	
Active	Active	The selected Counter is Enabled	
Counter Status	counterStatus	Returns the current state of the counter.	1.00 Expert DFNC
Counter Idle	CounterIdle	The counter is idle. The counterStartSource feature is set to off.	
Counter Trigger Wait	CounterTriggerWait	The counter is waiting for a start trigger.	
Counter Active	CounterActive	The counter is counting for the specified duration.	
Counter Completed	CounterCompleted	The counter reached the CounterDuration count.	
Counter Overflow	CounterOverflow	The counter reached its maximum possible count.	1.10 Expert DFNC
Counter Start Source	counterStartSource	Select the counter start source. Counter increments from 0 to the value of the counterDuration feature.	
Off	Off	Counter is stopped.	
Acquisition Start	AcquisitionStart	Counter starts on the reception of the Acquisition Start event.	
Acquisition End	AcquisitionEnd	Counter starts on the reception of the Acquisition End event.	
Exposure Start	ExposureStart	Counter starts on the reception of the Exposure Start event	
Exposure End	ExposureEnd	Counter starts on the reception of the Exposure End event.	
Readout Start	ReadoutStart	Counter starts on the reception of the Readout Start event.	
Readout End	ReadoutEnd	Counter starts on the reception of the Readout End event.	
Frame Start	FrameStart	Counter starts on the reception of the Frame Start event.	
Valid Frame Trigger	ValidFrameTrigger	Counter starts on the reception of the Valid Frame Trigger.	
Rejected Frame Trigger	InvalidFrameTrigger	Counter starts on the reception of the Invalid Frame Trigger.	
Action 1	Action1	GigE Vision Action Command 1. This is a broadcast command that multiple devices can respond to simultaneously. (1.03)	
Action 2	Action2	GigE Vision Action Command 2. This is a broadcast command that multiple devices can respond to simultaneously. (1.03)	
Line 1	Line1	Counter starts on the specified transitions on Line 1 See Input Signals Electrical Specifications.	
Line 2	Line2	Counter starts on the specified transitions on Line 2	
Output 1	Line3	Counts the number of transitions (based on the counterIncrementalLineActivation feature setting) of Output 1.	
Output 2	Line4	Counts the number of transitions (based on the counterIncrementalLineActivation feature setting) of Output 2.	
Timer 1 End	Timer1End	Counter starts on the reception of the Timer 1 End event.	
Counter 1 End	Counter1End	Counter starts on the reception of the Counter 1 End event.	

Counter Start Line Activation	counterStartLineActivation	Selects the activation mode of the input line trigger which starts the counter. This is only applicable when the counterStartSource feature selects a physical Line.	1.00 Expert DFNC
<i>Rising Edge</i>	<i>RisingEdge</i>	<i>Starts counting on rising edge of the selected Line.</i>	
<i>Falling Edge</i>	<i>FallingEdge</i>	<i>Starts counting on falling edge of the selected Line.</i>	
<i>Any Edge</i>	<i>AnyEdge</i>	<i>Starts counting on the falling or rising edge of the selected Line.</i>	
Counter Incremental Source	counterIncrementalSource	Select the event source which increments the counter. The Event Control section provides details and timing diagrams for the supported events.	1.00 Expert DFNC
<i>Off</i>	<i>Off</i>	<i>Counter is stopped.</i>	
<i>Acquisition Start</i>	<i>AcquisitionStart</i>	<i>Counts the number of Acquisition Start events.</i>	
<i>Acquisition End</i>	<i>AcquisitionEnd</i>	<i>Counts the number of Acquisition End events.</i>	
<i>Exposure Start</i>	<i>ExposureStart</i>	<i>Counts the number of Exposure Start events.</i>	
<i>ExposureEnd</i>	<i>ExposureEnd</i>	<i>Counts the number of Exposure End events.</i>	
<i>Readout Start</i>	<i>ReadoutStart</i>	<i>Counts the number of Readout Start events.</i>	
<i>Readout End</i>	<i>ReadoutEnd</i>	<i>Counts the number of Readout End events.</i>	
<i>Frame Start</i>	<i>FrameStart</i>	<i>Counts the number of Frame Start events.</i>	
<i>Valid Frame Trigger</i>	<i>ValidFrameTrigger</i>	<i>Counts the number of Valid Frame Triggers.</i>	
<i>Rejected Frame(s) Trigger</i>	<i>InvalidFrameTrigger</i>	<i>Counts the number of Rejected Frame(s) Trigger.</i>	
<i>MultiFrame End Trigger</i>	<i>FrameBurstEnd</i>	<i>Counts the number of multi-frame end triggers</i>	
<i>Line 1</i>	<i>Line1</i>	<i>Counts the number of transitions on Line 1 (based on the counterIncrementalLineActivation feature setting) See Input Signals Electrical Specifications.</i>	
<i>Line 2</i>	<i>Line2</i>	<i>Counts the number of transitions on Line 2 (based on the counterIncrementalLineActivation feature setting)</i>	
<i>Output 1</i>	<i>Line3</i>	<i>Counts the number of transitions of Output 1 (based on the counterIncrementalLineActivation feature setting)</i>	
<i>Output 2</i>	<i>Line4</i>	<i>Counts the number of transitions of Output 2 (based on the counterIncrementalLineActivation feature setting)</i>	
<i>Internal Clock</i>	<i>InternalClock</i>	<i>The counter increments on each microsecond tick of the device internal Clock.</i>	
<i>Timer 1 End</i>	<i>Timer1End</i>	<i>Counts the number of Timer 1 End events.</i>	
Counter Incremental Line Activation	counterIncrementalLineActivation	Selects the counter signal activation mode. The counter increments on the specified signal edge or level.	1.00 Expert DFNC
<i>Rising Edge</i>	<i>RisingEdge</i>	<i>Increment the counter on the rising edge of the selected I/O Line.</i>	
<i>Falling Edge</i>	<i>FallingEdge</i>	<i>Increment the counter on the falling edge of the selected I/O Line.</i>	
<i>Any Edge</i>	<i>AnyEdge</i>	<i>Increment the counter on the falling or rising edge of the selected I/O Line.</i>	
Counter Duration	counterDuration	Sets the duration (or number of events) before the CounterEnd event is generated.	1.00 Expert DFNC
Counter Reset Source	counterResetSource	Selects the signal source to reset the counter. After a reset the counter waits for the next countStartSource signal or event.	1.10 Expert DFNC
<i>Reset Cmd</i>	<i>Off</i>	<i>Reset on reception of the Reset Icommand.</i>	
<i>Acquisition Start</i>	<i>AcquisitionStart</i>	<i>Reset on reception of the Acquisition Start.</i>	
<i>Acquisition End</i>	<i>AcquisitionEnd</i>	<i>Reset on reception of the AcquisitionEnd</i>	
<i>Exposure Start</i>	<i>ExposureStart</i>	<i>Reset on reception of the Exposure Start event.</i>	
<i>Exposure End</i>	<i>ExposureEnd</i>	<i>Reset on reception of the Exposure End event.</i>	

<i>Readout Start</i>	<i>ReadoutStart</i>	Reset the counter on the reception of the Readout Start event.	
<i>Readout End</i>	<i>ReadoutEnd</i>	Reset the counter on the reception of the Readout End event.	
<i>Frame Trigger</i>	<i>FrameStart</i>	Reset on reception of the Frame Trigger.	
<i>Valid Frame Trigger</i>	<i>ValidFrameTrigger</i>	Reset on reception of the Valid Frame Trigger.	
<i>Rejected Frame Trigger</i>	<i>InvalidFrameTrigger</i>	Reset on reception of the Invalid Frame Trigger.	
<i>MultiFrame End Trigger</i>	<i>FrameBurstEnd</i>	Reset on reception of the Frame Burst end.	
<i>Line 1</i>	<i>Line1</i>	Reset counter on the specified transition on line 1. See Input Signals Electrical Specifications.	
<i>Line 2</i>	<i>Line2</i>	Reset counter on the specified transition on line 2.	
<i>Output 1</i>	<i>Line3</i>	Counts the number of transitions of Output 1 (based on the counterIncrementalLineActivation feature setting).	
<i>Output 2</i>	<i>Line4</i>	Counts the number of transitions of Output 2 (based on the counterIncrementalLineActivation feature setting).	
<i>Timer 1 End</i>	<i>Timer1End</i>	Reset on reception of the Timer End.	
<i>Counter 1 End</i>	<i>Counter1End</i>	Reset on the reception of the Counter end.	
Counter Reset Input Line Activation	counterResetLineActivation	Specify the edge transition on the selected line that will reset the selected counter.	1.00 Expert DFNC
<i>Rising Edge</i>	<i>RisingEdge</i>	Reset counter on rising edge of the selected signal.	
<i>Falling Edge</i>	<i>FallingEdge</i>	Reset counter on falling edge of the selected signal.	
<i>Any Edge</i>	<i>AnyEdge</i>	Reset counter on the falling or rising edge of the selected signal	
Counter Value	counterValue	Read the current value of the selected counter.	1.00 Expert DFNC
Counter Value At Reset	counterValueAtReset	Stores the counter value of the selected counter when it was reset by a trigger or by an explicit Counter Reset command.	1.00 Expert DFNC
Counter Reset	counterReset	Resets the selected counter to zero. The counter starts immediately after the reset. To temporarily disable the counter, set the Counter Event Source feature to Off.	1.00 Expert DFNC
Timer Selector	timerSelector	Selects which timer to configure.	1.00 Expert DFNC
<i>Timer 1</i>	<i>Timer1</i>	<i>Timer 1 selected</i>	
Timer Mode	timerMode	Select the Timer mode. The selected Timer is Active or Disabled. When Disabled, the Timer can be configured.	1.00 Expert DFNC
<i>Off</i>	<i>Off</i>	<i>The selected Timer is Disabled.</i>	
<i>Active</i>	<i>Active</i>	<i>The selected Timer is Enabled.</i>	
Timer Status	timerStatus	Returns the current state of the timer.	1.00 Expert DFNC
<i>Timer Idle</i>	<i>TimerIdle</i>	<i>The timer is idle. The CounterStartSource feature is set to off.</i>	
<i>Timer Trigger Wait</i>	<i>TimerTriggerWait</i>	<i>The timer is waiting for a start trigger.</i>	
<i>Timer Active</i>	<i>TimerActive</i>	<i>The timer is counting for the specified duration.</i>	
<i>Timer Completed</i>	<i>TimerCompleted</i>	<i>The timer reached the TimerDuration count.</i>	
Timer Start Source	timerStartSource	Select the trigger source to start the timer. The Event Control section provides details and timing diagrams for the supported events.	1.00 Expert DFNC
<i>TimerReset Cmd</i>	<i>Off</i>	<i>Starts with the reception of the TimerReset Icommand.</i>	
<i>Acquisition Start</i>	<i>AcquisitionStart</i>	<i>Start Timer on Acquisition Start event.</i>	
<i>Acquisition End</i>	<i>AcquisitionEnd</i>	<i>Start Timer on Acquisition End event</i>	
<i>Exposure Start</i>	<i>ExposureStart</i>	<i>Start Timer on Exposure Start event.</i>	
<i>Exposure End</i>	<i>ExposureEnd</i>	<i>Start Timer on Exposure End event.</i>	

Readout Start	ReadoutEnd	Start Timer on Readout Start event.	
Readout End	ReadoutStart	Start Timer on Readout End event.	
Frame Start	FrameStart	Start Timer on Frame Start event.	
Frame Trigger	ValidFrameTrigger	Start Timer on Frame Trigger event.	
Frame Burst End	FrameBurstEnd	Start Timer on Frame Burst End event.	
Action 1	Action1	GigEVision Action Command 1. This is a broadcast command that multiple devices can respond to simultaneously. (1.03)	
Action 2	Action2	GigEVision Action Command 2. This is a broadcast command that multiple devices can respond to simultaneously. (1.03)	
Line 1	Line1	Start Timer on a transition of I/O Line 1 event. See Input Signals Electrical Specifications.	
Line 2	Line2	Start Timer on a transition of I/O Line 2 event.	
Timer 1 End	Timer1End	Start Timer on Timer End event.	
Counter 1 End	Counter1End	Start Timer on Counter 1 End event.	
Timer Line Activation	timerStartLineActivation	Select the trigger activation mode which starts the timer.	1.00 Expert DFNC
Rising Edge	RisingEdge	Starts counter on rising edge of the selected signal.	
Falling Edge	FallingEdge	Starts counter on falling edge of the selected signal.	
Any Edge	AnyEdge	Starts counter on the falling or rising edge of the selected signal.	
Timer Duration	timerDuration	Sets the duration (in microseconds) of the timer pulse.	1.00 Expert DFNC
Timer Value	timerValue	Reads the current value (in microseconds) of the selected timer.	1.00 Expert DFNC
Timer Reset	timerReset	Resets the timer to 0 while <i>timerStatus=TimerActive</i> . Timer then waits for the next <i>timerStartSource</i> event.	1.00 Expert DFNC

Counter and Timer Group Block Diagram

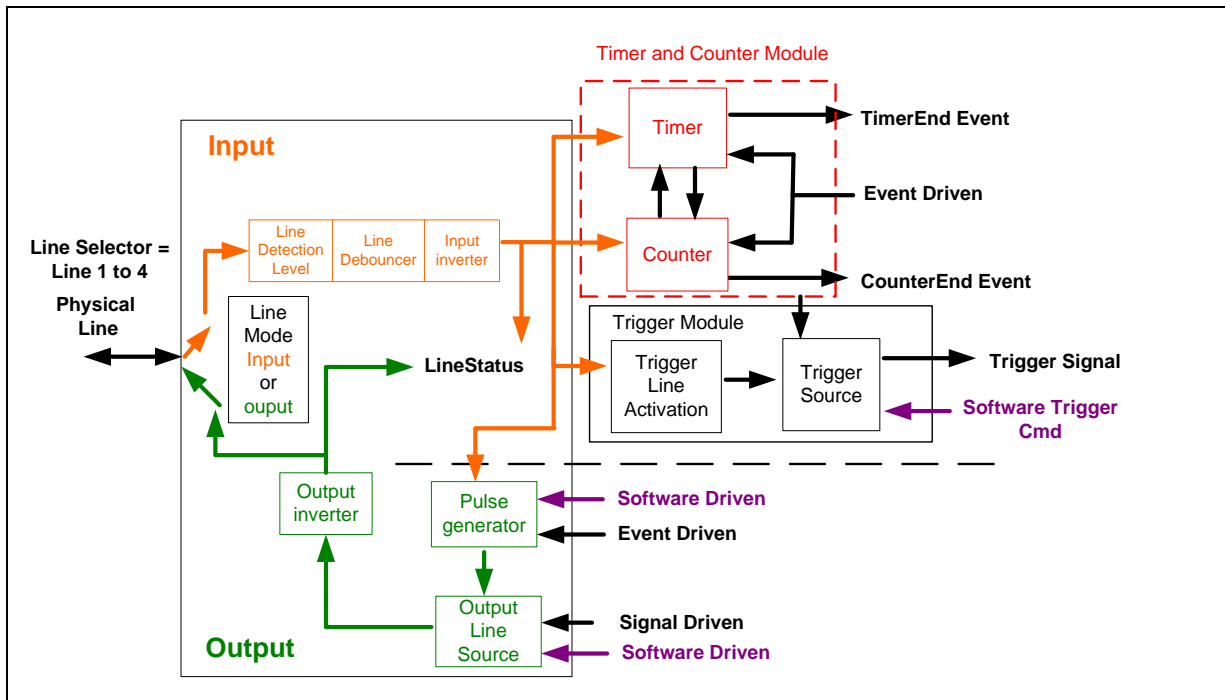

Example: Counter Start Source = OFF

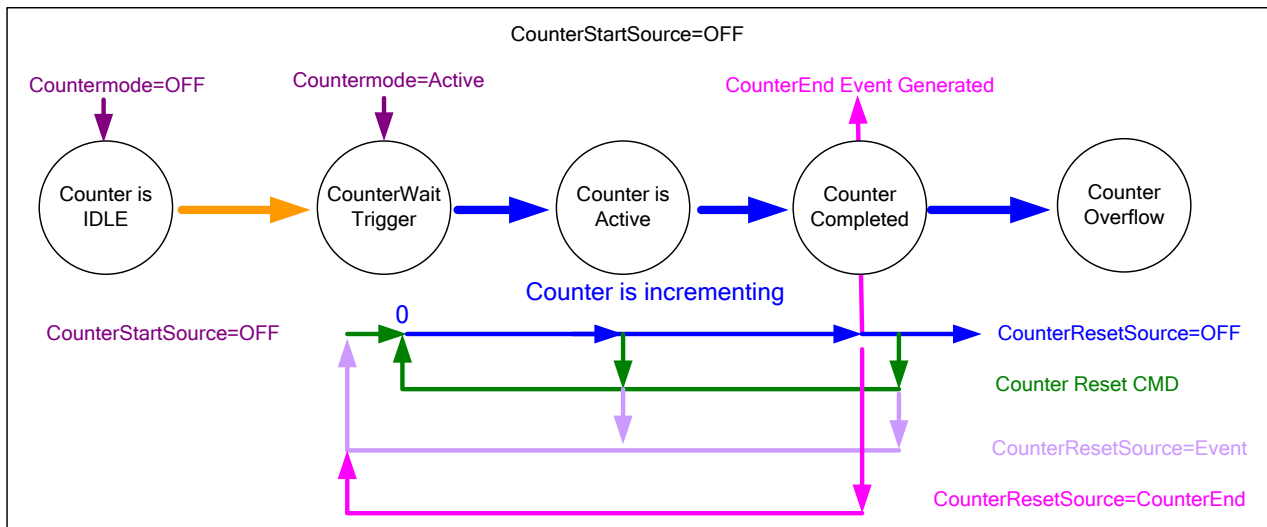

- The counter starts on the **counterReset Cmd**.
- The counter continues unless a new **counterReset Cmd** is received, which then restarts the counter at 00.
- When **Counter Reset Source= 'Event' or 'CounterEnd'** the counter is reset to 00 but does not restart counting, until the next **CounterReset Cmd**.

Example: Counter Start Source = CounterEnd (itself)

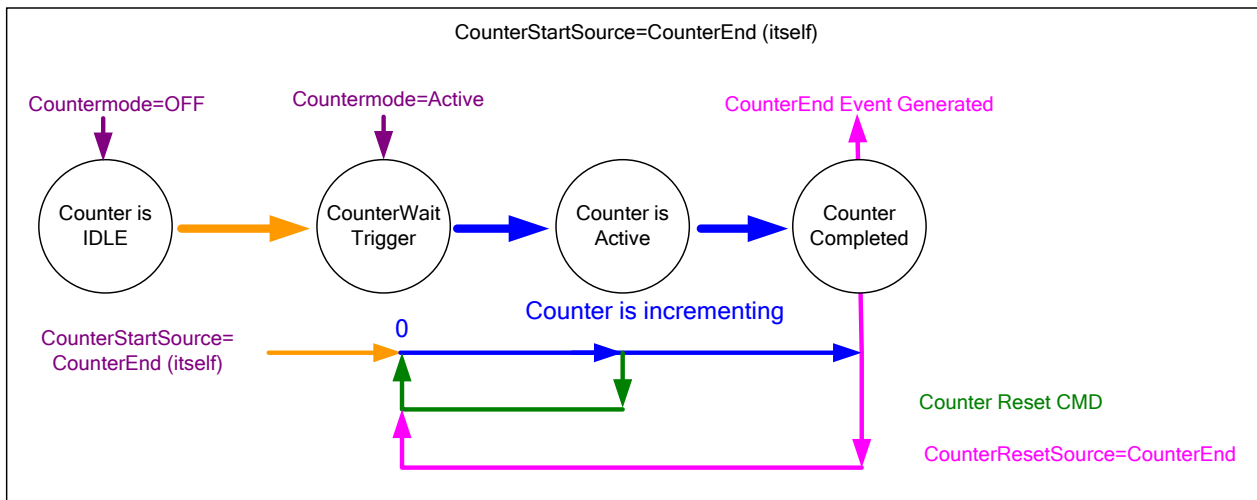

- Counter starts when Counter Mode is set to Active.
- A **Counter Reset CMD** will reset the counter to 00 and it then continues counting.
- **counterResetSource** must be set to **CounterEnd**. When the counterValue feature reaches the counterDuration value an event is generated and the counter is reset to 00, then continues.

Example: CounterStartSource = EVENT and Signal (Edge Base)

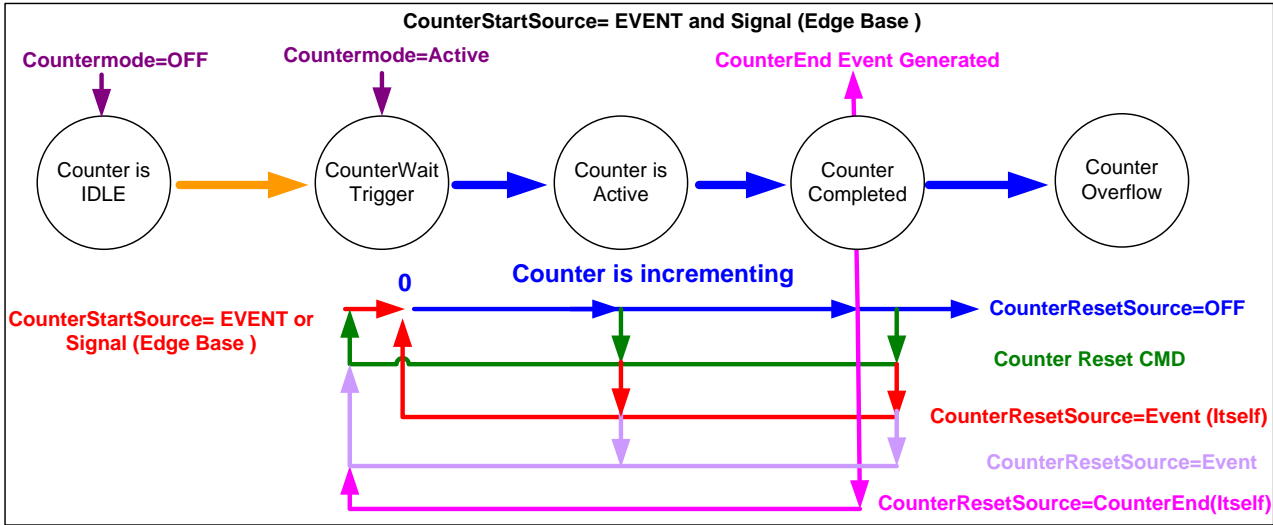

Example: CounterStartSource = Line (Edge Base) Example 2

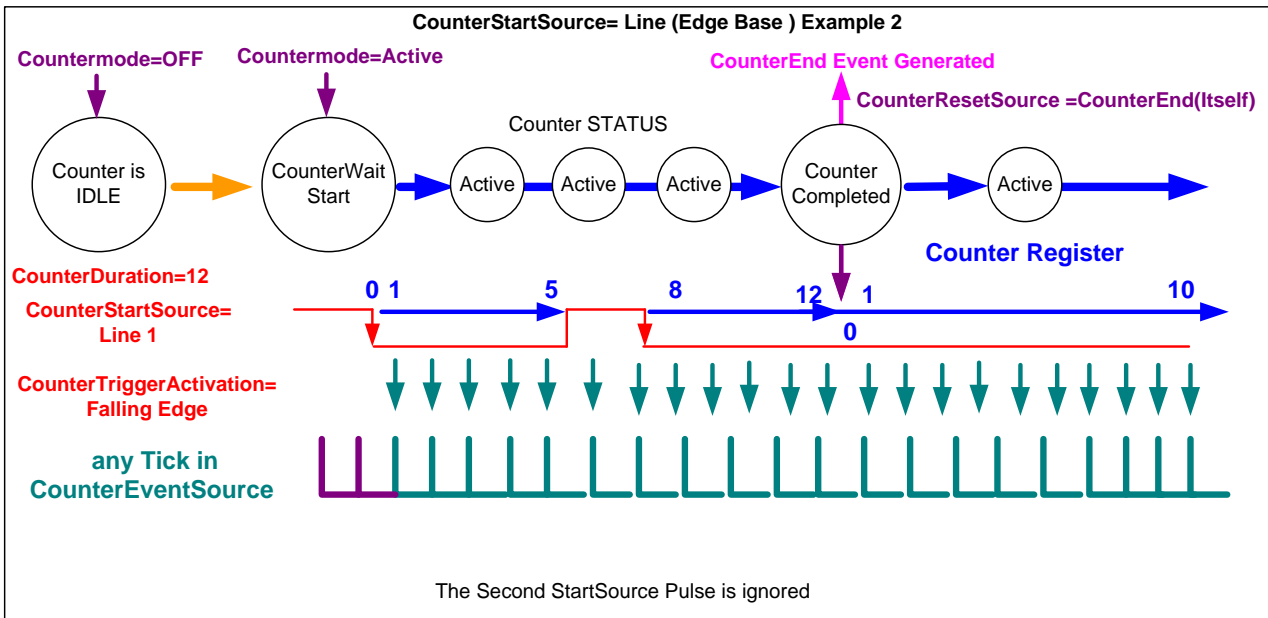

Advanced Processing Control Category

The Genie Nano Advanced Processing controls, as shown by CamExpert, groups parameters used to configure LUT mode controls on monochrome cameras. Parameters in gray are read only, either always or due to another parameter being disabled. Parameters in black are user set in CamExpert or programmable via an imaging application.

Features listed in the description table but tagged as *Invisible* are usually for Teledyne DALSA or third party software usage—not typically needed by end user applications.

Also important, Genie Nano cameras are available in a number of models implementing different sensors and image resolutions which may not support the full feature set defined in this category.

Category	Parameter	Value
Camera Information	Defective Pixel Replacement Mode	Active
⊞ Sensor Control	Defective Pixel Replacement Map C...	Factory Map
I/O Controls	Noise Reduction Mode	Off
Counter And Timer Control	LUT Mode	Off
⊞ Advanced Processing	LUT Type	User Defined
Cycling Preset	Gamma Correction	Not Enabled
Image Format Controls	LUT Selector	Luminance 1
⊞ Metadata Controls	LUT Size ion	8 Bits/Pixel
Acquisition and Transfer Cont...	LUT Index	0
Action Control	LUT Value	0
⊞ Event Control	LUT Value All	
GigE Vision Transport Layer	<< Less	
File Access Control		
GigE Vision Host Controls		

Advanced Processing Control Feature Descriptions

The following table describes these features along with their view attribute and device version. For each feature the device version may differ for each camera sensor available. Such feature differences will be clearly indicated.

As Genie Nano capabilities evolve the device firmware version will increase, therefore identifying the supported function package. New features for a major device version release will be indicated by **green text** for easy identification, for that new manual release.

The description column will indicate which feature is a member of the Teledyne DALSA Features Naming Convention (indicated by DFNC), versus the GenICam Standard Features Naming Convention (SFNC not shown).

Display Name	Feature & Values	Description	Version	Model Notes
Defective Pixel Replacement Mode	defectivePixelReplacementMode	Sets the mode for the defective pixel replacement.	Ver. 1.04 Expert DFNC	OnSemi Python monochrome and Sony 9M & 12M
<i>Off</i>	<i>Off</i>	<i>Defective Pixel Replacement is disabled.</i>		
<i>Active</i>	<i>Active</i>	<i>Defective Pixel Replacement is enabled.</i>		
Defective Pixel Replacement Map Current Active Set	defectivePixelReplacementMapCurrentActiveSet	Sets the defective pixel replacement set.	Ver. 1.04 Expert DFNC	OnSemi Python monochrome and Sony 9M & 12M
<i>Factory Map</i>	<i>FactoryMap</i>	<i>Sets the factory coefficient table as active.</i>		
<i>User Map 1</i>	<i>UserMap1</i>	<i>Sets the User Map coefficient table as active.</i>		
Defective Pixel Replacement Algorithm	defectivePixelReplacementAlgorithm	Specifies the defective pixel replacement algorithm.	Ver. 1.07 Expert DFNC	OnSemi Python monochrome and Sony 9M & 12M
<i>Method3: Neighboring Pixel</i>	<i>Method3</i>	<i>This algorithm replaces a defective pixel with a neighbor.</i>		
Noise Reduction Mode	noiseReduction	Sets the mode for the pixel noise reduction.	Ver. 1.06 Expert DFNC	M/C 5100 & M/C 4900 only
<i>Off</i>	<i>Off</i>	<i>Noise Reduction is disabled.</i>		
<i>Active</i>	<i>Active</i>	<i>Noise Reduction is enabled.</i>		
LUT Mode	lutMode	Sets the enable state of the selected LUT module (Lookup Table).	Ver. 1.03 Expert DFNC	
<i>Off</i>	<i>Off</i>	<i>Disables the LUT.</i>		
<i>Active</i>	<i>Active</i>	<i>Enables the selected LUT module.</i>		
LUT Type	lutType	Displays the LUT type of the currently selected Lookup Table.	Ver. 1.03 Expert DFNC	Ver. 1.06 Available with Bayer Color firmware – all color models
<i>User Defined</i>	<i>UserDefined</i>	<i>Uses the user programmable LUT.</i>		
<i>Gamma Correction</i>	<i>GammaCorrection</i>	<i>Uses gamma LUT</i>		
LUT Selector	LUTSelector	Selects which LUT to control and adjust features.	Ver. 1.03 Guru	
<i>Luminance 1</i>	<i>Luminance1</i>	<i>Luminance 1 is under control</i>		
<i>RED</i>	<i>RED</i>	<i>LUT Red is under control</i>		
<i>Green</i>	<i>Green</i>	<i>LUT Green is under control</i>		
<i>Blue</i>	<i>Blue</i>	<i>LUT Blue is under control</i>		
LUT Size	lutSize	Specify the LUT size of the selected LUT (Lookup Table). Available choices are model dependent.	Ver. 1.03 Guru DFNC	
<i>8 Bits/Pixel</i>	<i>Bpp8</i>	<i>8 bits per pixel</i>		
<i>10 Bits/Pixel</i> <i>12 Bits/Pixel</i>	<i>Bpp10</i> <i>Bpp12</i>	<i>10 bits per pixel</i> <i>12 bits per pixel</i>		
LUT Index	LUTIndex	Selects the index (offset) of the coefficient to access in the selected LUT.	Ver. 1.03 Guru	

LUT Value	LUTValue	Returns the value at specified LUT index entry of the LUT selected by the LUT Selector feature.	Ver. 1.03 Guru	
LUT Value All	LUTValueAll	Accesses all the LUT coefficients in a single access without using individual LUT indices. This feature accesses the LUT values in the currently active LUT table set by the LUT Current Active Set feature.	Ver. 1.03 Guru	
Processing path bits per pixel	processingPathBpp	< >	Ver. 1.03 Invisible DFNC	
LUT Current Active Set	lutCurrentActiveSet	Specifies the current LUT to use. < Invisible, DFNC >	Ver. 1.05 Invisible DFNC	
<i>Luminance 1</i>	<i>Luminance1</i>	<i>Sets the current LUT as Luminance 1.</i>		
<i>LUT RGB</i>	<i>RGB</i>	<i>Sets the current LUT as RGB.</i>		

Lookup Table (LUT) Overview

The Genie Nano cameras include a user programmable LUT table as a component of its embedded processing features. A LUT is used for operations such as gamma adjustments, invert and threshold processes.

The camera LUT table are dependent on the sensor (per pixel – see feature *LUT Size*) and is illustrated in the following figure (see *Processing path bits per pixel*). Pixel data from the sensor is passed through the LUT memory array, where the new programmed pixel value is then passed to the Genie output circuit. The LUT data table is stored along with other parameters with the user configuration function.

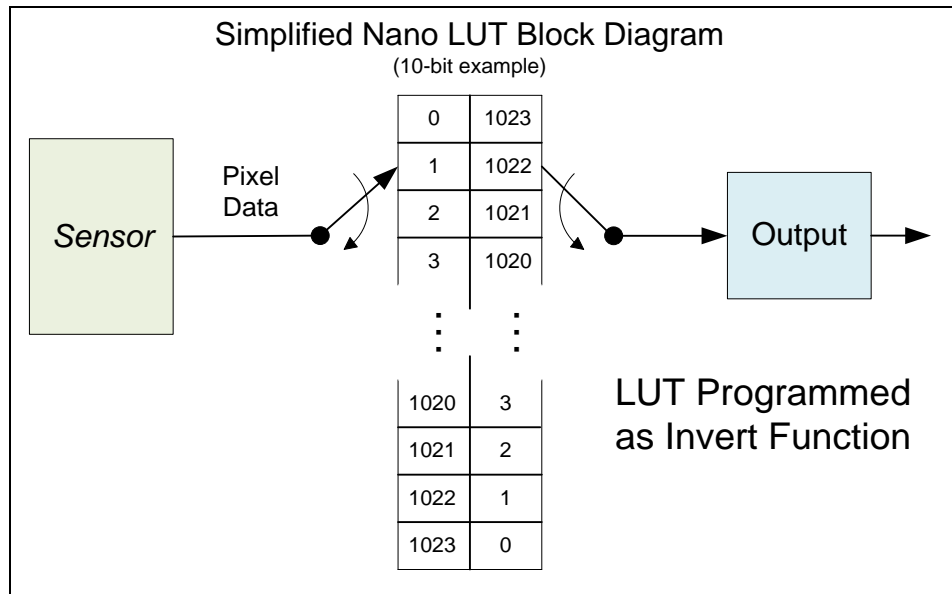

Simplified Example 10-bit LUT Block Diagram

LUT Size vs. Output Pixel Format

The LUT size will be the same as the camera’s sensor pixel size. All camera processing is performed at the sensor pixel format of the camera, while the user chooses the output pixel format (such as 8-bit).

Using the example of a 10-bit Nano camera, the LUT table is also 10-bit. The Nano default neutral LUT programming is as follows:

- When the **Output Pixel format = 10-bit**, the default LUT data value is equal to the LUT index value for each index. This is a linear LUT that does not modify the sensor data.
- When the **Output Pixel format = 8-bit**, the default LUT data is programmed to map the 1024 sensor pixel values to 256 output values. Therefore LUT index “0 to 3” have the value “0”, LUT index “4 to 7” have the value “1”, and so on until the last group where LUT index “1020 to 1023” have the value “255”.

LUT data is selected either as a predefined gamma correction, or is programmed with individual values for various LUT index entries, or a user LUT data file is upload using the File Access controls. Refer to the Sapera documentation for information about the SapLut Class. Note that a SapLut file can be uploaded to the Nano but cannot be read back.

Defective Pixel Replacement (Method 3)

The Pixel Replacement algorithm is based on a predefined bad pixel map (as an XML file), either supplied by the factory (file loaded as "Factory Map") or generated by the user (file uploaded as "User Map 1"). The number of bad pixel entries is limited and varies dependent on the Nano model. The following XML code sample forms the template for the user to build bad pixel maps for any of their Nano cameras.

Note: Identifying bad pixels is left to the user's discretion, but Teledyne DALSA technical support can provide guidance.

Example User Defective Pixel Map XML File

The following example shows the required components of the defective pixel map file. Each bad pixel position (relative to the image origin which is the upper left corner), must be identified by the XML statement:

```
<DefectivePixel OffsetX="number" OffsetY="number"/>
```

The pixel format (whether 8, 10, 12-bit) is handled transparently, thus requires no special consideration by the user.

This example XML listing has four "bad" pixels identified (maximum number of entries is model dependent). The Algorithm descriptions that follows defines the rules used by the Nano firmware to replace an identified bad pixel.

```
<?xml version="1.0" encoding="UTF-8" ?>
<!--Example User Defective Pixel Map →
<!--      maximum 512 coordinates →
<!--filename: NanoExampleBadPixels.xml →

<Coordinates>

<DefectivePixel OffsetX="100" OffsetY="0" />
<DefectivePixel OffsetX="28" OffsetY="345" />
<DefectivePixel OffsetX="468" OffsetY="50" />
<DefectivePixel OffsetX="800" OffsetY="600" />

</Coordinates>
```

An sample editable defective pixel map replacement file will be available to download with Nano firmware files.

Defective Pixel Replacement Algorithm Description

The replacement algorithm follows a few basic rules as defined below, which in general provides satisfactory results.

Monochrome Cameras

- If the bad pixel is the first of a line, it is replaced by the next whether good or not.
- If the bad pixel is not the first of a line, it is replaced by the previous pixel.

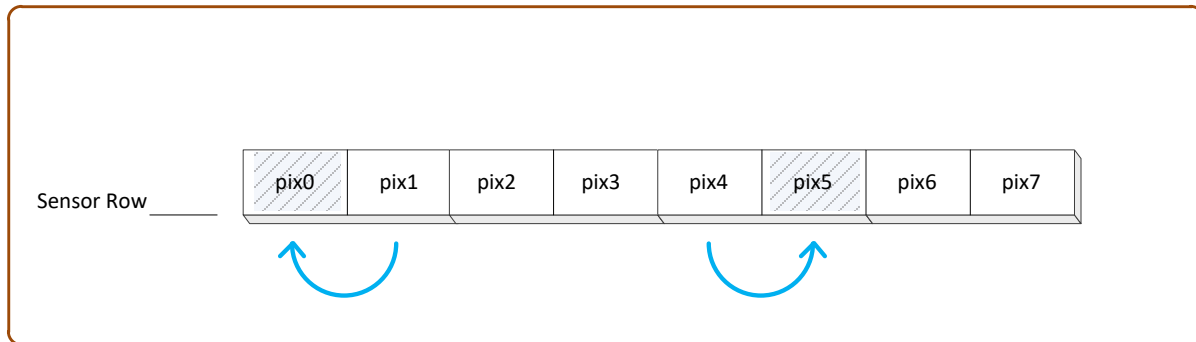

Color Cameras

The replacement algorithm rules for Bayer a color sensor is similar to the monochrome rules with the exception that replacement pixels of the same color as the bad are used. The two replacement cases below describe general color pixel replacements.

- If the bad pixel is the first of a line, it is replaced by the next of the same color, whether good or not.
- If the bad pixel is not the first of a line, it is replaced by the previous pixel of the same color.

Color Processing Control Category

The Nano Color Processing controls, as shown by CamExpert, has parameters used to configure the color camera white balance/color balance features.

Parameters in gray are read only, either always or due to another parameter being disabled. Parameters in black are user set in CamExpert or programmable via an imaging application

Features listed in the description table but tagged as *Invisible* are usually for Teledyne DALSA or third party software usage—not typically needed by end user applications. Also important, Genie Nano cameras are available in a number of models implementing different sensors and image resolutions which may not support the full feature set defined in this category.

Note that the following screen shows a color Nano with the optional **RGB-Output Design** firmware loaded (certain models only). The last two features (Color Enhancement) are not offered with the Standard Bayer Color firmware (used with all color Nano cameras).

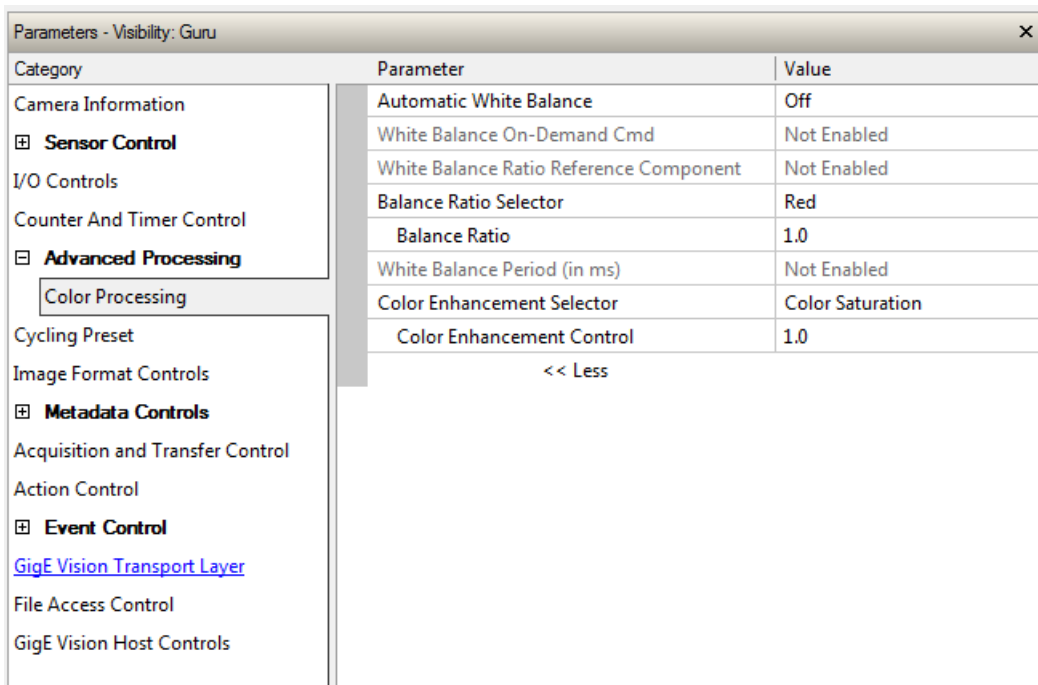

Category	Parameter	Value
Camera Information	Automatic White Balance	Off
☒ Sensor Control	White Balance On-Demand Cmd	Not Enabled
I/O Controls	White Balance Ratio Reference Component	Not Enabled
Counter And Timer Control	Balance Ratio Selector	Red
☒ Advanced Processing	Balance Ratio	1.0
Color Processing	White Balance Period (in ms)	Not Enabled
Cycling Preset	Color Enhancement Selector	Color Saturation
Image Format Controls	Color Enhancement Control	1.0
☒ Metadata Controls	<< Less	
Acquisition and Transfer Control		
Action Control		
☒ Event Control		
GigE Vision Transport Layer		
File Access Control		
GigE Vision Host Controls		

Color Processing Control Feature Description

The following table describes these features along with their view attribute and device framework version. For each feature the device version may differ for each camera sensor available. Such differences will be clearly indicated for any applicable feature.

As Genie Nano capabilities evolve the device firmware version will increase, therefore identifying the supported function package. New features for a major device version release will be indicated by **green text** for easy identification.

The description column will indicate which feature is a member of the Teledyne DALSA Features Naming Convention (denoted by DFNC), versus the GenICam Standard Features Naming Convention (SFNC not shown).

Display Name	Feature & Values	Description	Device Version & View
Automatic White Balance	BalanceWhiteAuto	Controls the mode for automatic white balancing between the color channels. The color gains are automatically adjusted.	1.04 Expert
<i>Off</i>	<i>Off</i>	<i>White balancing is manually controlled using BalanceRatio[Red], BalanceRatio[Green] and BalanceRatio[Blue].</i>	
<i>On Demand</i>	<i>OnDemand</i>	<i>White balancing is automatically adjusted once by the device.</i>	
<i>Periodic</i>	<i>Periodic</i>	<i>White balancing is periodically adjusted by the device (i.e. when the scene is known to be neutral).</i>	
White Balance Period	balanceWhitePeriod	White balance correction period.	1.05 Expert DFNC
White Balance On-Demand Cmd	balanceWhiteAutoOnDemandCmd	Executes the automatic white balance function. The first frame acquired is used to calculate the RGB gain adjustments, which are then applied to subsequent snaps or grabs.	1.04 Expert DFNC
White Balance Ratio Reference Component	balanceRatioReference	Selects which color component to use as the reference point for BalanceWhiteAuto.	1.04 Expert DFNC
<i>Red</i>	<i>Red</i>	<i>Red component will remain constant after the white balance adjustment.</i>	
<i>Green</i>	<i>Green</i>	<i>Green component will remain constant after the white balance adjustment.</i>	
<i>Blue</i>	<i>Blue</i>	<i>Blue component will remain constant after the white balance adjustment.</i>	
<i>Automatic</i>	<i>Auto</i>	<i>The reference color component is automatically selected so that the minimum component's gain becomes 1.00.</i>	
Balance Ratio Selector	BalanceRatioSelector	Selects which color gain is controlled with the BalanceRatio feature.	1.04 Expert
<i>Red</i>	<i>Red</i>	<i>RED gain is controlled by Balance Ratio.</i>	
<i>Green</i>	<i>Green</i>	<i>Green gain is controlled by Balance Ratio.</i>	
<i>Blue</i>	<i>Blue</i>	<i>BLUE gain is controlled by Balance Ratio.</i>	
Balance Ratio	BalanceRatio	Sets the digital gain of the selected color component (BalanceRatioSelector).	1.04 Expert
White Balance Period	balanceWhitePeriod	White balance correction period in milliseconds. (RO)	1.05 Expert DFNC
Color Enhancement Selector	colorEnhancementSelector	Select the color attribute to control.	1.05 RGB Firmware Expert DFNC
<i>Color Saturation</i>	<i>Saturation</i>	<i>User set gain of the color saturation component, ranging from 1 to 4x.</i>	
<i>Luminance</i>	<i>Luminance</i>	<i>User set gain of the luminance component.</i>	
Color Enhancement Control	colorEnhancementControl	Control the color attribute selected by colorEnhancementSelector.	1.05 RGB Firmware Expert DFNC

Color Processing Functional Overview

Nano color cameras provide White Balance controls (automatic or manual), and additionally with supported models, the optional RGB firmware provides Saturation and Luminance controls. These features are described below in more detail. Note that computer monitors have wide variations in

displaying color. Users should consider using professional monitors which have factory calibrated fixed presets conforming to sRGB or AdobeRGB color spaces.

White Balance Operation

The Nano white balance control allow either manual settings for the RGB gain levels, or an automatic algorithm executing periodically or on demand. Automatic mode operates under the assumption of a color neutral scene, where an IR filter installed on the Nano camera is recommended for most applications.

For Manual Adjustments

- RGB values range from 1 to 4, in 0.01 increments.
- Use *BalanceRatioSelector* to select the RGB gain to adjust and use *BalanceRatio* to change the gain value.
- The user selects one color to stay fixed at a gain of 1.00 (often green).
- Adjust the gain for R & B to achieve the white balance desired.

For Automatic Adjustments

With either periodic or on demand modes, the Nano will determine the color to set to a gain of 1.00, and then adjust the other two color gains. The *BalanceRatio* feature will show gain settings at higher precision than user set values.

- Set *BalanceWhiteAuto* to Periodic or OnDemand.
- The periodic mode will recalculate every 10ms, while the on demand mode requires the execution of *balanceWhiteAutoOnDemandCmd*.
- The user can override the automatic choice of the color referenced to a gain of zero via the *balanceRatioReference* feature, but often the results look false colored.

Simplified RGB Design Firmware Block Diagram

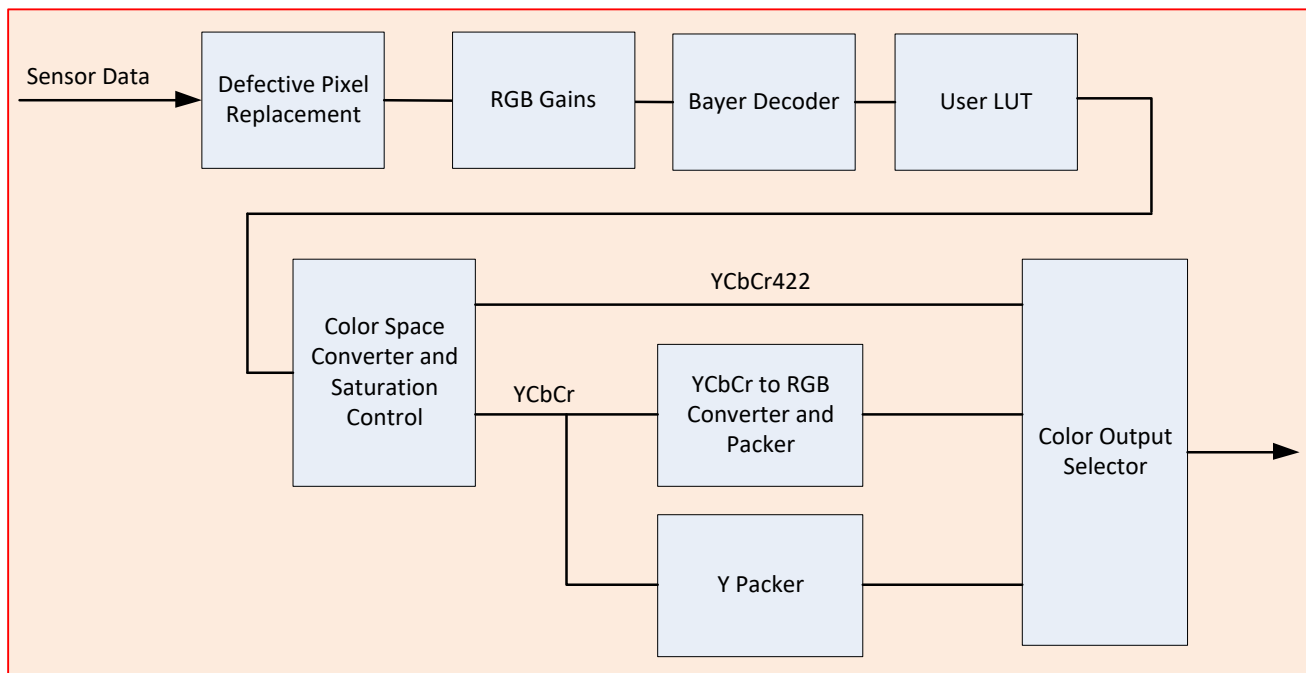

Saturation and Luminance Operation

The optional RGB Output Design firmware for OnSemi sensor Nano models provides two additional control features for color control. In simple terms these controls are:

- Saturation — Increases the color intensity relative to the default gain level
- Luminance — Increases the overall luminance gain level

Examples of Saturation and Luminance effects with integer value settings are shown below.

Saturation Control Examples

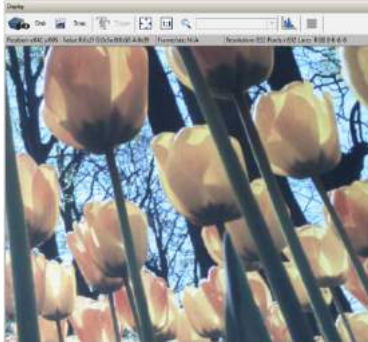

Saturation=1



Saturation=2



Saturation=3

Luminance Control Examples



Saturation=2, Luminance=1



Saturation=2, Luminance=2

The Math behind the Saturation/Luminance Controls

Nano RGB firmware combines user control inputs with captured video RGB values using the formulas described below.

Luminance is applied to the Y and chrominance (saturation) is applied to Cb (U) and Cr (V).

$$Y = \frac{9798 \times R + 19235 \times G + 3736 \times B}{32768} \times \text{Luminance Factor}$$

$$Cb = \frac{-5529 \times R - 10855 \times G + 16384 \times B}{32768} \times \text{Chrominance Factor} + X$$

$$Cr = \frac{16384 \times R - 13720 \times G - 2664 \times B}{32768} \times \text{Chrominance Factor} + X$$

Where:

X is 128 if data path bit-depth is 8-bit

X is 512 if data path bit-depth is 10-bit

X is 2048 if data path bit-depth is 12-bit

Flat Field Correction Category

The Nano Flat Field Correction controls, as shown by CamExpert, has parameters used to correct sensor or lens luminance differences. Currently these controls are available on the **NanoXL** models M/C 5100 and M/C 4090.

Parameters in gray are read only, either always or due to another parameter being disabled. Parameters in black are user set in CamExpert or programmable via an imaging application

Features listed in the description table but tagged as *Invisible* are usually for Teledyne DALSA or third party software usage—not typically needed by end user applications.

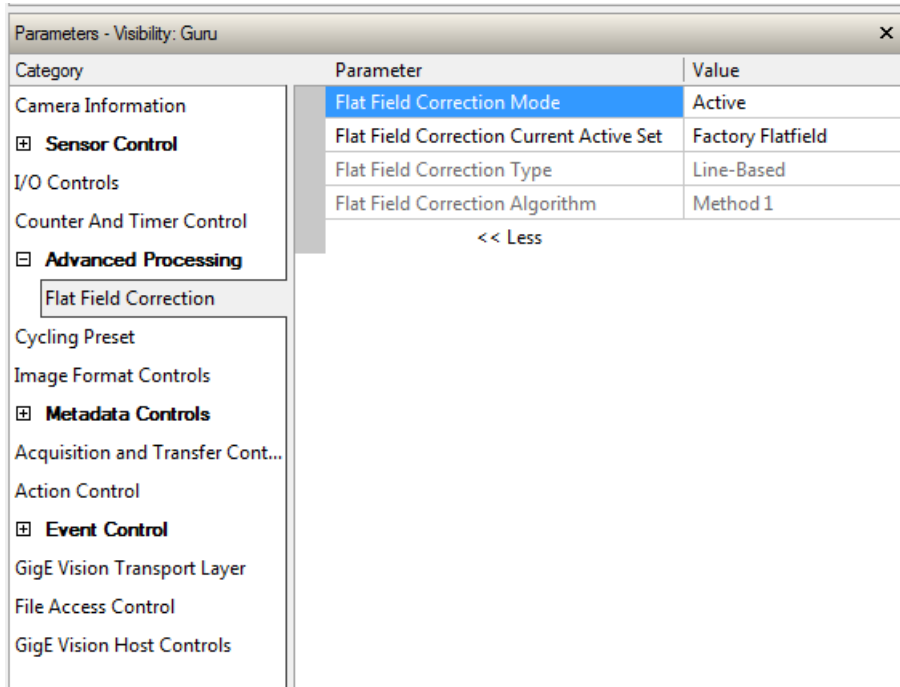

Flat Field Correction Feature Description

The following table describes these features along with their view attribute and device framework version. For each feature the device version may differ for each camera sensor available. Such differences will be clearly indicated for any applicable feature.

As Genie Nano capabilities evolve the device firmware version will increase, therefore identifying the supported function package. New features for a major device version release will be indicated by green text for easy identification.

The description column will indicate which feature is a member of the Teledyne DALSA Features Naming Convention (denoted by DFNC), versus the GenICam Standard Features Naming Convention (SFNC not shown).

Display Name	Feature & Values	Description	Device Version & View
Flat Field Correction Mode	flatfieldCorrectionMode	Sets the mode for the Flat Field correction.	1.06 Beginner DFNC NanoXL
<i>Off</i>	<i>Off</i>	<i>Flat Field Correction is disabled.</i>	
<i>Active</i>	<i>Active</i>	<i>Flat Field Correction is enabled.</i>	
<i>Calibration</i>	<i>Calibration</i>	<i>When this mode is selected, the camera is configured for flat field correction calibration. The device may automatically adjust some of its features when calibrate mode is enabled. The features that are automatically adjusted are device specific. The device will not restore these features when the Flat Field Correction Mode feature is changed from Calibrate mode to another mode. <Expert></i>	
Flat Field Correction Current Active Set	flatfieldCorrectionCurrentActiveSet	Specifies the current set of Flat Field coefficients to use.	1.06 Beginner DFNC NanoXL
<i>Factory Flatfield</i>	<i>FactoryFlatfield</i>	<i>Sets the factory Flat Field coefficient table as the current Flat Field.</i>	
<i>User Flatfield 1</i>	<i>UserFlatfield1</i>	<i>Sets User Flat Field 1 coefficient table as the current Flat Field.</i>	
Flat Field Correction Type	flatfieldCorrectionType	Specifies the Flat Field correction type.	1.06 Guru DFNC NanoXL
<i>Line-Based</i>	<i>LineBase</i>	<i>Flat field correction is based on a single line of gain and offset coefficients.</i>	
Flat Field Correction Algorithm	flatfieldCorrectionAlgorithm	Specifies the Flat Field correction algorithm to use.	1.06 Guru DFNC NanoXL
<i>Method 1</i>	<i>Method1</i>	<i>The following formula is used to calculate the flat field corrected pixel: $newPixelValue[x][y] = (sensorPixelValue[x][y] - FFCOffset[x][y]) * FFCGain[x][y]$</i>	
Flat Field Algorithm Buffer Format	flatfieldAlgorithmBufferFormat		1.06 Invisible DFNC
<i>Mono8</i>	<i>Mono8</i>		
Flat Field Algorithm Buffer Width	flatfieldAlgorithmBufferWidth		1.06 Invisible DFNC
Flat Field Algorithm Buffer Height	flatfieldAlgorithmBufferHeight		1.06 Invisible DFNC
Flat Field Algorithm Gain Max	flatfieldAlgorithmGainMax		1.06 Invisible DFNC
Flat Field Algorithm Gain Min	flatfieldAlgorithmGainMin		1.06 Invisible DFNC
Flat Field Algorithm Gain Divisor	flatfieldAlgorithmGainDivisor		1.06 Invisible DFNC
Flat Field Algorithm Gain Base	flatfieldAlgorithmGainBase		1.06 Invisible DFNC
Flat Field Algorithm Offset Max	flatfieldAlgorithmOffsetMax		1.06 Invisible DFNC
Flat Field Algorithm Offset Min	flatfieldAlgorithmOffsetMin		1.06 Invisible DFNC
Flat Field Algorithm Offset Factor	flatfieldAlgorithmOffsetFactor		1.06 Invisible DFNC

Cycling Preset Mode Control Category

The Genie Nano Cycling Preset controls, as shown by CamExpert, has parameters used to configure the camera Cycling features. Cycling controls allow the user to configure a number of camera operational states and then have the camera automatically switch between states in real-time. Only the features programmed to change are updated when switching between camera states, thus ensuring immediate camera response. A setup example follows the feature table.

Parameters in gray are read only, either always or due to another parameter being disabled. Parameters in black are user set in CamExpert or programmable via an imaging application

Features listed in the description table but tagged as *Invisible* are usually for Teledyne DALSA or third party software usage—not typically needed by end user applications. Also important, Genie Nano cameras are available in a number of models implementing different sensors and image resolutions which may not support the full feature set defined in this category.

Note: This feature set is not available with the Nano C4900 (rolling shutter) camera.

Category	Parameter	Value
Camera Information	Cycling Preset Mode	Off
⊞ Sensor Control	Cycling Preset Count	2
I/O Controls	Cycling Preset Incremental Source	Start of Frame
Counter And Timer Control	Trigger Input Line Activation	Not Enabled
⊞ Advanced Processing	Cycling Preset Repeater	1
Color Processing	Cycling Preset Reset Source	Acquisition End
Cycling Preset	Cycling Preset Reset Cmd	Not Enabled
Image Format Controls	Cycling Preset Current Active Set	1
⊞ Metadata Controls	Cycling Preset ROI Position Source	FPGA
Acquisition and Transfer Control	Features Activation Selector	Exposure Time
Action Control	Features Activation Mode	Off
⊞ Event Control	Preset Configuration Selector	1
GigE Vision Transport Layer	Exposure Time (in us)	10009
File Access Control	Exposure Delay (in us)	Not Enabled
GigE Vision Host Controls	Gain Selector	Sensor
	Gain	1.0
	Horizontal Offset	0
	Vertical Offset	0
	Line Selector	Line 3
	Output Line Source	Not Enabled
	Output Line Value	Not Enabled
	<< Less	

Cycling Preset Mode Control Feature Description

The following table describes these features along with their view attribute and device framework version. For each feature the device version may differ for each camera sensor available. Such differences will be clearly indicated for any applicable feature.



As Genie Nano capabilities evolve the device firmware version will increase, therefore identifying the supported function package. New features for a major device version release will be indicated by **green text** for easy identification.

The first column indicates whether a feature applies to monochrome or color camera models via a symbol. No symbol indicates a common feature. Additionally the description column will indicate which feature is a member of the Teledyne DALSA Features Naming Convention (denoted by DFNC), versus the GenICam Standard Features Naming Convention (SFNC not shown).

B/W Color	Display Name	Feature & Values	Description	Sony Sensors	OnSemi Sensors
	Cycling Preset Mode	cyclingPresetMode	Sets the Cycling Presets module mode. < Expert, DFNC > <i>Note: not available on rolling shutter model C4900</i>	Ver. 1.01	Ver. 1.00
	<i>Off</i>	<i>Off</i>	<i>Disable the Cycling Preset module.</i>		
	<i>Active</i>	<i>Active</i>	<i>Enable the Cycling Preset module.</i>		
	Cycling Preset Count	cyclingPresetCount	Specifies the number of Presets to use. < Expert, DFNC >	Ver. 1.01	
	Cycling Preset Incremental Source	cyclingPresetIncrementalSource	Specifies the source that increments the currently active cycling preset. < Expert, DFNC >	Ver. 1.01	
	<i>None</i>	<i>None</i>	<i>Feature cyclingPresetCurrentActiveSet is used to select the current active set.</i>		
	<i>Valid Frame Trigger</i>	<i>ValidFrameTrigger</i>	<i>Increment on a Valid Frame Trigger</i>		
	<i>Counter 1 End</i>	<i>Counter1End</i>	<i>Increment on the end of Counter 1.</i>		
	<i>Start of Frame</i>	<i>StartOfFrame</i>	<i>Increment on the Start of Frame event</i>		
	<i>Line2</i>	<i>Line2</i>	<i>Select Line 2 (and associated I/O control block) to use as the external increment source.</i>		
	Trigger Input Line Activation	cyclingPresetIncrementalActivation	Select the activation mode for the selected Input Line source. This is applicable only for external line inputs. < Expert, DFNC >	Ver. 1.01	
	<i>Rising Edge</i>	<i>RisingEdge</i>	<i>The source is considered valid on the rising edge of the line source signal (after being process by the line inverter feature).</i>		
	<i>Falling Edge</i>	<i>FallingEdge</i>	<i>The source is considered valid on the falling edge of the line source signal (after being process by the line inverter feature).</i>		
	<i>Any Edge</i>	<i>AnyEdge</i>	<i>The source is considered valid on any edge (falling or rising) of the line source signal (after being process by the line inverter feature).</i>		

	Cycling Preset Repeater	cyclingPresetRepeater	Specifies the required number of cycling preset increment events (generated by the Cycling Preset Incremental Source) to increment the index of the Cycling Preset Current Active Set. < Expert, DFNC >	Ver. 1.01	
	Cycling Preset Reset Source	cyclingPresetResetSource	Specifies the source that resets the currently active preset. On reset the current preset index is set to 1. < Expert, DFNC >	Ver. 1.01	
	<i>Valid Frame Trigger</i>	<i>ValidFrameTrigger</i>	<i>Reset when a Valid Frame Triggers occurs.</i>		
	<i>Counter 1 End</i>	<i>Counter1End</i>	<i>Reset when counter 1 ends.</i>		
	<i>Acquisition End</i>	<i>EndOfAcquisition</i>	<i>Use End of Acquisition as the reset source. An End of Acquisition occurs on acquisition stop.</i>		
	<i>Software</i>	<i>Software</i>	<i>Use a software command as the reset source.</i>		
	Cycling Preset Reset Cmd	cyclingPresetResetCmd	Reset the position of the preset cycling to 1 and the count to 0. < Guru, DFNC >	Ver. 1.01	
	Cycling Preset Current Active Set	cyclingPresetCurrentActiveSet	Returns the index of the currently active cycling preset. < Guru, DFNC >	Ver. 1.01	
	Cycling Preset ROI Source	cyclingPresetRoiPositionSource	Specifies the source that cycles the ROI position (availability is sensor dependent). <Expert, DFNC> <i>Note: Only on OnSemi Python sensor models</i>	—	Ver. 1.05 OnSemi Python
	<i>In-FPGA</i>	<i>FPGA</i>	<i>The FPGA cycles the ROI position.</i>		
	<i>In-Sensor</i>	<i>Sensor</i>	<i>The sensor cycles the ROI position.</i>		
	Features Activation Selector	cP_FeaturesActivationSelector	Selects the feature to control by the cP_FeaturesActivationMode feature. < Expert, DFNC >	Ver. 1.01	
	<i>Exposure Time</i>	<i>ExposureTime</i>	<i>The cP_FeaturesActivationMode feature controls the exposure time.</i>		
	<i>Exposure Delay</i>	<i>ExposureDelay</i>	<i>The cP_FeaturesActivationMode feature controls the exposure delay.</i>		
	<i>ROI Position</i>	<i>ROI_Position</i>	<i>The cP_FeaturesActivationMode feature will control ROI position.</i>		
	<i>Output Line3</i>	<i>OutputLine3Control</i>	<i>The cP_FeaturesActivationMode feature controls the output line 3.</i>		
	<i>Output Line4</i>	<i>OutputLine4Control</i>	<i>The cP_FeaturesActivationMode feature controls the output line 4.</i>		
	<i>Binning Horizontal</i>	<i>BinningHorizontal</i>	<i>The cP_FeaturesActivationMode controls the horizontal binning.</i>		Ver. 1.03
	<i>Binning Vertical</i>	<i>BinningVertical</i>	<i>The cP_FeaturesActivationMode controls the vertical binning.</i>		Ver. 1.03
	<i>Sensor Analog Gain</i>	<i>SensorAnalogGain</i>	<i>The cP_FeaturesActivationMode controls the sensor analog gain.</i>		Ver. 1.04

	Features Activation Mode	cP_FeaturesActivationMode	Enables the selected feature to be part of the cycling. When activating the selected feature, this will automatically set the corresponding standard camera feature to read only. < Expert, DFNC >	Ver. 1.01	
	<i>Off</i>	<i>Off</i>	<i>Exclude the selected feature from the cycling.</i>		
	<i>Active</i>	<i>Active</i>	<i>Include the selected feature in the cycling.</i>		

	Preset Configuration Selector	cP_PresetConfigurationSelector	Selects the cycling preset to configure. < Expert, DFNC >	Ver. 1.01	
	Exposure Time	cP_ExposureTime	Sets the exposure time (in microseconds) for the selected set. The maximum frame rate is dependent on the longest cycling exposure time. < Expert, DFNC >	Ver. 1.01	
	Exposure Delay	cP_ExposureDelay	Sets the exposure delay (in microseconds) for the selected set. < Expert, DFNC >	Ver. 1.01	
	Gain Selector	cP_GainSelector	Selects which gain is controlled when adjusting cp_Gain features. < Expert, DFNC >	Ver. 1.04	Ver. 1.04
	<i>Sensor</i>	<i>SensorAll</i>	<i>Applies to Sony sensor models: Gain is adjusted within the sensor. The first half of the gain range is applied in the analog domain and the second half is digital.</i>	Ver. 1.04	Ver. 1.04
	<i>Sensor Analog</i>	<i>SensorAnalog</i>	<i>Applies to OnSemi sensor models: Analog gain is adjusted within the sensor.</i>		
	Gain	cP_Gain	Sets the selected gain as an amplification factor applied to the image. This gain is applied when the current Cycling index is active. < Expert, DFNC >	Ver. 1.04	Ver. 1.04
	Horizontal Offset	cP_OffsetX	Horizontal offset from the origin to the region of interest (ROI). The value in this feature is only used when the currently selected cycling preset is active. < Expert, DFNC >	Ver. 1.01	Ver. 1.05
	Vertical Offset	cP_OffsetY	Vertical offset from the origin to the region of interest (ROI). The value in this feature is only used when the currently selected cycling preset is active. < Expert, DFNC >	Ver. 1.01	Ver. 1.05
	Binning Horizontal	cP_BinningHorizontal	Number of horizontal photo-sensitive cells to combine together. This increases the intensity of the pixels but reduces the horizontal resolution of the image. < Expert, DFNC >	Ver. 1.03	Ver. 1.03
	Binning Vertical	cP_BinningVertical	Number of vertical photo-sensitive cells to combine together. This increases the intensity of the pixels but reduces the vertical resolution of the image. < Expert, DFNC >	Ver. 1.03	Ver. 1.03
	Line Selector	cP_LineSelector	Selects which physical line (or pin) of the external device connector to configure. < Expert, DFNC >	Ver. 1.01	

	<i>Line 3</i>	<i>Line3</i>	<i>Index of the physical line and associated I/O control block to use. Pin 6 is the Output Signal and Pin 4 is the common output power on the I/O connector.</i>		
	<i>Line 4</i>	<i>Line4</i>	<i>Index of the physical line and associated I/O control block to use. Pin 8 is the Output Signal and Pin 4 is the common output power on the I/O connector.</i>		
	Output Line Source	cP_OutputLineSource	Selects which internal signal, or event driven pulse, or software control state to output on the selected output line. < Expert, DFNC >	Ver. 1.01	
	<i>Off</i>	<i>Off</i>	<i>Line output is Open – no output source selected.</i>		
	<i>Software Controlled</i>	<i>SoftwareControlled</i>	<i>The OutputLineValue feature changes the state of the output.</i>		
	<i>Pulse On: Start of Exposure</i>	<i>PulseOnStartofExposure</i>	<i>Generate a pulse on the ExposureStart event. This is typically used to trigger a strobe light.</i>		
	<i>Exposure Active</i>	<i>ExposureActive</i>	<i>Generate a signal that is active when the exposure is active.</i>		
	Output Line Value	cP_OutputLineValue	Sets the output state of the selected Line if the outputLineSoftwareLatchControl = OFF. OutputLineSource must be SoftwareControlled. If the outputLineSoftwareLatchControl=Latch, the state of the pin will change with the outputLineSoftwareCmd command. < Expert, DFNC >	Ver. 1.01	
	<i>Active</i>	<i>Active</i>	<i>Sets the Output circuit to closed.</i>		
	<i>Inactive</i>	<i>Inactive</i>	<i>Sets the Output circuit to open.</i>		

Using Cycling Presets—a Simple Example

As presented in this category's overview, the cycling preset features allows setting up camera configurations that can change dynamically and repeatedly, with minimum overhead. The features that change along with the trigger for the feature change are preprogrammed in the camera. Additionally a set of preset features can be updated while the camera is acquiring with a different preset. Such dynamic feature changes allow applications to perform tracking algorithms.

The following example describes a simple cycling sequence (using free running acquisitions) with exposure change steps which will repeat until stopped by the user. This example uses the Spera tool CamExpert to set features and test the sequence.

Multi-Exposure Cycling Example Setup

- For this example, first configure a free running acquisition of 20 fps with an exposure time that's somewhat short (dark). These controls are in the Sensor Control Category group within CamExpert.
- Now select the Cycling Preset Category to setup and test the following example.
- Set *cyclingPresetMode* to *Active*. This feature enables the Cycling Preset Module.
- Set *cyclingPresetCount* to the number of presets which will be configured and used. For this example set this to 4.
- Set the feature *cyclingPresetIncrementalSource* to the event which will be used to increment the cycling presets index. For this example, set this feature to *StartOfFrame* which is a logical choice in a free-running acquisition setup.
- Set the feature *cyclingPresetRepeater* to the number of incremental source events to count before switching to the next preset. In this example we are counting *StartOfFrame* events, thus a value of 20 (with a test setup of 20 fps) will switch presets every 1 second.
- The feature *cyclingPresetResetSource* is optional for this example. This defines the event which will reset the preset index back to 1. In this example, by setting the feature to *EndOfAcquisition* we know that when Freeze is clicked in CamExpert to stop the free-running acquisition, the cycling preset index is returned to the start (1).
- Set *PresetConfigurationSelector* to index 1.
- Set *FeaturesActivationSelector* to *ExposureTime* (the exposure initially set as somewhat dark).
- Set *FeaturesActivationMode* to *Active*. This defines the camera exposure as one variable stored in this preset index 1.
- The feature *ExposureTime* shows the last exposure time used by the camera (when cycling was not enabled). This field now controls the camera exposure time. The primary exposure time field in the Sensor Control Category is in gray text indicating a read only field.
- Set *PresetConfigurationSelector* to index 2.
- Set the feature *ExposureTime* to a higher value, increasing the acquisition brightness.
- Repeat for index 3 with an exposure a bit longer again, and index 4 with an even longer exposure.

Test the Example

- With 4 different exposure times saved in four presets, click the CamExpert Grab button to start the cycling free-running acquisition.
- The CamExpert live display window will show a live grab of 20 fps, where each second shows a four step increase in exposure, which then returns to the first exposure cycling continuously until stopped by the user.

Cycling Reset Timing Details

This section describes the Nano Cycling function with two cycling feature configurations. These configurations (or cases) are dependent on the cycling preset increment source as follows:

- **Internal Synchronous Increment:** Where the preset increment source is either FrameStart or ValidFrameTrigger (*cyclingPresetIncrementalSource= StartOfFrame or ValidFrameTrigger*).
- **External Asynchronous Increment:** Where the preset increment source is either Timer, Line or Software (*cyclingPresetIncrementalSource= Counter1End or Line2 or None*).

Case 1: Cycling with Internal Synchronous Increment

With an Internal Synchronous Cycling Increment, a cycling reset command will execute on the next cycling increment event.

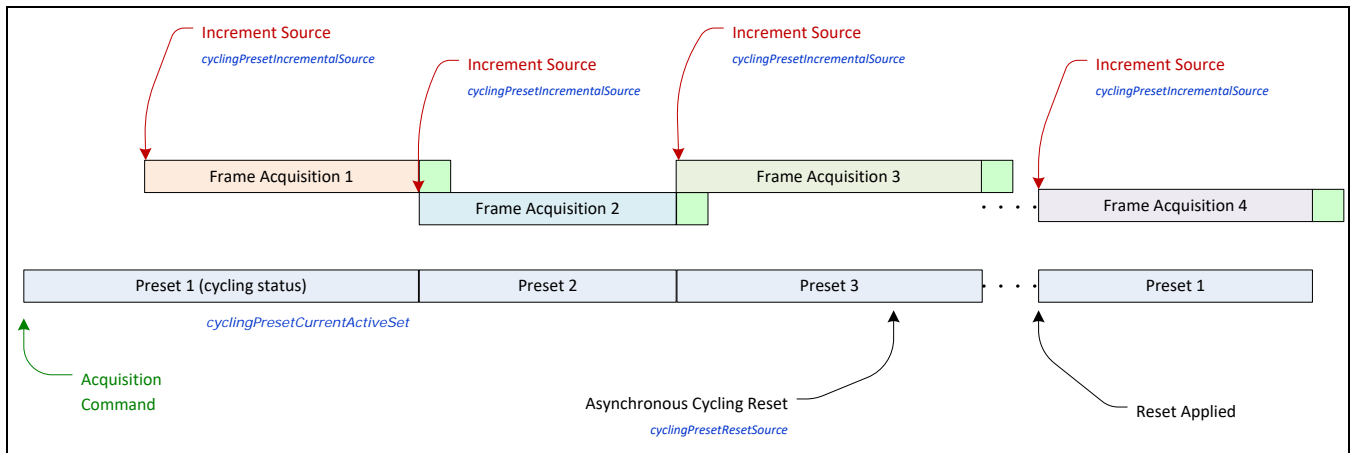

Case 2: Cycling with External Asynchronous Increment

With an External Asynchronous Cycling Increment, a cycling reset command executes immediately and sets the cycling preset to set number 1.

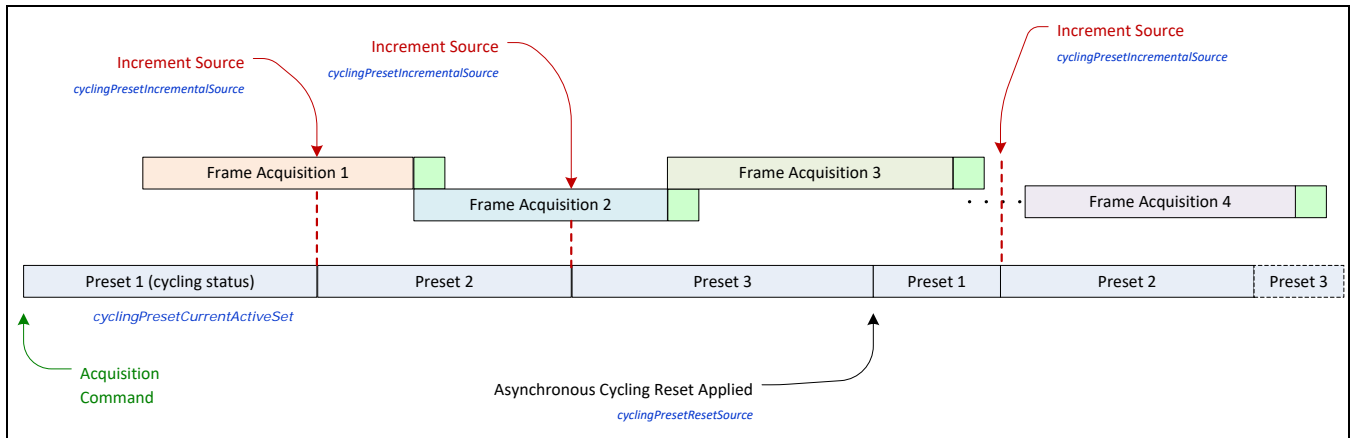

Using Cycling Presets with Output Controls

The following graphic shows a Cycling Preset function setup where a two stage setup performs exposures of different length and additionally provides an output pulse at the start of each exposure.

As an example, by using both output lines, this setup can trigger two separate light strobes of different wavelengths. This dual exposure sequence example is controlled by a single external trigger.

Feature Settings for this Example

Below are listed key features for this setup. Other Nano features will be as required by the user.

- **I/O Controls:**
 - TriggerSelector = FrameBurstStart
 - TriggerMode = On
 - triggerFrameCount = 2
- **Cycling Preset**
 - cyclingPresetMode = Active
 - cyclingPresetCount = 2
 - cyclingPresetIncrementalSource = StartOfFrame
 - cP_FeaturesActivationSelector = ExposureTime
 - cP_FeaturesActivationMode = Active (plus set required exposure for each cycling preset)
 - cP_LineSelector = Line3 (for preset 1) and Line4 (for preset 2)
 - cP_OutputLineSource = PulseOnStartofExposure (line3–preset 1, line4–preset 2)

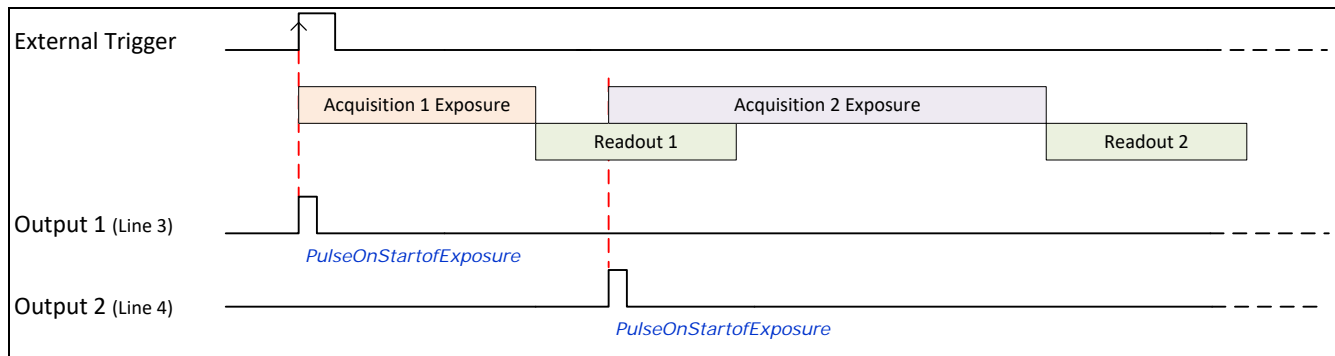

Cycling Mode Constraints with a changing ROI

The Nano Cycling Mode features support a changing ROI from one cycling preset to the next. The ROI in this case refers to a single acquisition area which is a subset of the complete image frame.

The initial ROI size and position (i.e. features *Width*, *Height*, *OffsetX*, *OffsetY*) is setup via the Image Format group of features. Obviously the defined initial ROI area would be smaller so as to allow it to be moved around via the Cycling Mode *OffsetX* and *OffsetY* features set for each Cycling Preset.

Specifics Concerning OnSemi Sensor Models

Nano Models using OnSemi Python Sensors implement an in-sensor ROI mode which can maximize the possible acquisition frame rate. The following characteristics apply:

- Since OnSemi sensors support in-sensor ROI mode, only the ROI bounded sensor data is read out, which can increase the maximum possible frame rate.
- The firmware for Nano OnSemi sensors will load the ROI X and Y offset settings for the next cycling mode preset frame, during the readout period of the current frame. Again this will maximize possible frame rates.
- When enabling in sensor ROI, the *exposureAlignment* is set to Reset.
- The Frame Rate might decrease due to the maximum frame rate becoming lower. The original value is not restored when Cycling Mode in-Sensor ROI mode is disabled.
- Exposure time might increase due to the minimum exposure time becoming higher. The original value is not restored when the in-sensor ROI mode is disabled.

Specifics Concerning Sony Sensor Models

Sony sensors can only use in-FPGA ROI settings, thus the complete sensor area must be readout to the processing FPGA. Then the defined ROI area is read out of the FPGA and transmitted to the host computer. This characteristic of Sony sensors does not provide any frame rate advantage when using various ROI selections with Cycling Mode acquisitions.

Image Format Control Category

The Genie Nano Image Format controls, as shown by CamExpert, has parameters used to configure camera pixel format, image cropping, image flip, Binning, multiple ROI and selecting a test output image without a lens.

Parameters in gray are read only, either always or due to another parameter being disabled. Parameters in black are user set in CamExpert or programmable via an imaging application.

Features listed in the description table but tagged as *Invisible* are usually for Teledyne DALSA or third party software usage—not typically needed by end user applications. Also important, Genie Nano cameras are available in a number of models implementing different sensors and image resolutions which may not support the full feature set defined in this category.









Category	Parameter	Value
Camera Information	Data Stream Selector	Stream1
<input checked="" type="checkbox"/> Sensor Control	Data Stream Type	Image
Auto-Brightness	Pixel Format	Monochrome 8-Bit
I/O Controls	Pixel Size	8
Counter And Timer Control	Horizontal Offset	0
<input checked="" type="checkbox"/> Advanced Processing	Vertical Offset	0
Color Processing	Width	1280
Cycling Preset	Height	1024
Image Format Controls	Vertical Flip	False
<input checked="" type="checkbox"/> Metadata Controls	Multiple ROI Mode	Off
Chunk Parser	ROI Count Horizontal	Not Enabled
Acquisition and Transfer Control	ROI Count Vertical	Not Enabled
Action Control	ROI Count	Not Enabled
<input checked="" type="checkbox"/> Event Control	ROI Selector	Not Enabled
GigE Vision Transport Layer	ROI Offset X	Not Enabled
File Access Control	ROI Offset Y	Not Enabled
GigE Vision Host Controls	ROI Width	Not Enabled
	ROI Height	Not Enabled
	Binning Selector	In Digital Domain
	Binning Horizontal	1
	Binning Vertical	1
	Test Image Selector	Off
	<< Less	

Image Format Control Feature Description

The following table describes these features along with their view attribute and device framework version. For each feature the device version may differ for each camera sensor available. Such differences will be clearly indicated for any applicable feature.



A Revision Version number represents the camera software firmware revision. As Genie Nano capabilities evolve the version will increase, therefore identifying the supported function package. New features for a major device version release will be indicated by **green text** for easy identification.









The first column indicates whether a feature applies to monochrome or color camera models via a symbol. No symbol indicates a common feature. Additionally the description column will indicate which feature is a member of the DALSA Features Naming Convention (denoted by DFNC), versus the GenICam Standard Features Naming Convention (SFNC tag is not shown).

B/W Color	Display Name	Feature & Values	Description	Sony Sensors	OnSemi Sensors	Nano C4900
	Data Stream Selector	dataStreamSelector	Select which data stream to control (default is Stream 1) < RO, Beginner, DFNC >			
	<i>Stream1</i>	<i>Stream1</i>	<i>Adjust parameters for Stream1.</i>			
	Data Stream Type	dataStreamType	This feature is used to retrieve the transfer protocol used to stream blocks. < RO, Beginner, DFNC >			
	<i>Image</i>	<i>Image</i>	<i>The Image data blocks are streamed using the payload type "Image".</i>			
	Pixel Format	PixelFormat	Format of the pixel provided by the device. Contains all format information as provided by PixelCoding, PixelSize, PixelColorFilter, combined in one single value. < Beginner >			
	<i>Monochrome 8-Bit</i>	<i>Mono8</i>	<i>Mono8: Monochrome 8-Bit</i>	<i>1.06 with RGB firmware</i>	<i>1.06 with RGB firmware</i>	<i>Ver. 1.06</i>
	<i>Monochrome 10-Bit</i>	<i>Mono10</i>	<i>Mono10: Monochrome 10-Bit</i>			
	<i>Monochrome 12-Bit</i>	<i>Mono12</i>	<i>Mono12: Monochrome 12-Bit</i>			
	<i>BayerGR 8-Bit</i>	<i>BayerGR8</i>	<i>Color camera: BayerGR8</i>	<i>1.05</i>	<i>1.05</i>	
	<i>BayerRG 8-Bit</i>	<i>BayerRG8</i>	<i>Color camera: BayerRG8t</i>			
	<i>BayerGB 8-Bit</i>	<i>BayerGB8</i>	<i>Color camera: BayerGB8</i>	<i>1.05</i>	<i>1.05</i>	
	<i>BayerBG 8-Bit</i>	<i>BayerBG8</i>	<i>Color camera: BayerBG8</i>	<i>1.05</i>	<i>1.05</i>	
	<i>BayerGR 10-Bit</i>	<i>BayerGR10</i>	<i>Color camera: BayerGR10</i>	<i>1.05</i>	<i>1.05</i>	
	<i>BayerRG 10-Bit</i>	<i>BayerRG10</i>	<i>Color camera: BayerRG10</i>			

	BayerGB 10-Bit	BayerGB10	Color camera: BayerGB10	1.05	1.05	
	BayerBG 10-Bit	BayerBG10	Color camera: BayerBG10	1.05	1.05	
	BayerGR 12-Bit	BayerGR12	Color camera: BayerGR12	1.05	1.05	
	BayerRG 12-Bit	BayerRG12	Color camera: BayerRG12			
	BayerGB 12-Bit	BayerGB12	Color camera: BayerGB12	1.05	1.05	
	BayerBG 12-Bit	BayerBG12	Color camera: BayerBG12	1.05	1.05	
	BGR 8-Bit Packed	BGR8	Color camera: BGR8 (RGB 24-bit)	—	1.05 RGB Design	Ver. 1.06
	BGRA 8-Bit Packed	BGRA8	Color camera: BGRA8 (RGBA 32-bit, [RGB 24 + Mono 8])	—	1.05 RGB Design	Ver. 1.06
	YUV422_8_YUYV	YUV422_8	Color camera: YUV422_8_YUYV (16-bit)	—	1.05 RGB Design	Ver. 1.06
	YUV422_8_UYVY	YUV422_8_UYVY	Color camera: YUV422_8_UYVY (16-bit)	—	1.05 RGB Design	Ver. 1.06
	YUV422_Packed	YUV422Packed	Color camera: YUV422Packed (16-bit)			Ver. 1.06
	Pixel Size	PixelSize	Total size in bits of an image pixel. < RO, Guru >			
	8 Bits/Pixel	Bpp8	Bpp8: 8 bits per pixel			
	10 Bits/Pixel	Bpp10	Bpp10: 10 bits per pixel			
	12 Bits/Pixel	Bpp12	Bpp12: 12 bits per pixel			
	16 Bits/Pixel	Bpp16	Bpp16: 16 bits per pixel			
	24 Bits/Pixel	Bpp24	Bpp24: 24 bits per pixel			
	32 Bits/Pixel	Bpp32	Bpp32: 32 bits per pixel			
	Horizontal Offset	OffsetX	Horizontal offset from the Sensor Origin to the Region Of Interest (in pixels). < Beginner >			
	Vertical Offset	OffsetY	Vertical offset from the Sensor Origin to the Region Of Interest (in Lines). < Beginner >			
	Width	Width	Width of the Image provided by the device (in pixels). < Beginner >			
	Height	Height	Height of the Image provided by the device (in lines). < Beginner >			
	Horizontal Flip	ReverseX	Horizontal image flip function (available on some models).		NA	Ver. 1.06
	Vertical Flip	ReverseY	Vertical image flip function (available on some models).		Ver. 1.01	Ver. 1.06
	Multiple ROI Mode	multipleROI Mode	Enable the Multiple ROI (Region of Interest) per image feature. The ROI Count is set by the Multiple ROI Count feature. < Expert, DFNC >			—
	Off	Off	Single ROI per image.			

	Active	Active	The ROI per image feature is active.			
	ROI Count Horizontal	multipleROICountHorizontal	Specifies the number of ROI (Region of Interest) available for the X axis. < Expert, DFNC >			—
	ROI Count Vertical	multipleROICountVertical	Specifies the number of ROI (Region of Interest) available for the Y axis. < Expert, DFNC >			—
	ROI Count	multipleROICount	Specifies the number of possible ROI (Region of Interest) available in an acquired image. One is minimum, while the maximum is device specific. < Expert, DFNC, RO >			
	ROI Selector	multipleROISelector	Select an ROI (Region of Interest) when Multiple ROI Mode is enabled. Selector range is from 1 to the Multiple ROI Count value. < Expert, DFNC >			—
	ROI (x1, y1)	roi1_1	ROI (x1, y1)			
	ROI (x2, y1)	roi2_1	ROI (x2, y1)			
	ROI (x3, y1)	roi3_1	ROI (x3, y1)			
	ROI (x4, y1)	roi4_1	ROI (x4, y1)			
	ROI (x1, y2)	roi1_2	ROI (x1, y2)			
	ROI (x2, y2)	roi2_2	ROI (x2, y2)			
	ROI (x3, y2)	roi3_2	ROI (x3, y2)			
	ROI (x4, y2)	roi4_2	ROI (x4, y2)			
	ROI (x1, y3)	roi1_3	ROI (x1, y3)			
	ROI (x2, y3)	roi2_3	ROI (x2, y3)			
	ROI (x3, y3)	roi3_3	ROI (x3, y3)			
	ROI (x4, y3)	roi4_3	ROI (x4, y3)			
	ROI (x1, y4)	roi1_4	ROI (x1, y4)			
	ROI (x2, y4)	roi2_4	ROI (x2, y4)			
	ROI (x3, y4)	roi3_4	ROI (x3, y4)			
	ROI (x4, y4)	roi4_4	ROI (x4, y4)			
	ROI Offset X	multipleROIOffsetX	Horizontal offset (in pixels) from the origin to the selected ROI (Region of Interest). < Expert, DFNC >			
	ROI Offset Y	multipleROIOffsetY	Vertical offset (in pixels) from the origin to the selected ROI (Region of Interest). < Expert, DFNC >			
	ROI Width	multipleROIWidth	Width of the selected ROI (Region of Interest) provided by the device (in pixels). < Expert, DFNC >			
	ROI Height	multipleROIHeight	Height of the selected ROI (Region of Interest) provided by the device (in pixels). < Expert, DFNC >			

	Binning Selector	binningSelector	Select how the Horizontal and Vertical Binning is done. The Binning function can occur in the Digital domain of a device or at the actual sensor. < Beginner >	Ver. 1.06 <i>(Available on some models)</i>	Ver. 1.03 <i>(Available on some models)</i>	—
	<i>In Sensor</i>	<i>InSensor</i>	<i>The Binning function can be done inside the Sensor itself, which often allows binning to increase the data rate from the sensor.</i>		Ver. 1.06 NanoXL	
	<i>In Digital Domain</i>	<i>InDigitalDomain</i>	<i>The Binning function can be done inside the device but with a digital processing function. Binning doesn't affect the current data rate from the sensor or camera.</i>			
	Binning Mode	binningMode	Sets the mode used to combine pixels together when BinningHorizontal and/or BinningVertical is greater than 1. < Beginner >	Ver. 1.07 <i>(Available on some models)</i>	Ver. 1.07 <i>(Available on some models)</i>	—
	<i>Sum</i>	<i>Sum</i>	<i>The responses from the individual pixels are added together, resulting in increased sensitivity.</i>		Ver. 1.07 NanoXL	
	<i>Average</i>	<i>Average</i>	<i>The responses from the individual pixels are averaged, resulting in increased signal to noise ratio.</i>			
	Binning Horizontal	BinningHorizontal	Number of horizontal pixels to combine together using the method selected by binningMode. This reduces the horizontal resolution of the image. < Beginner >		Ver. 1.03	
	Binning Vertical	BinningVertical	Number of vertical pixels to combine together using the method selected by binningMode. This reduces the vertical resolution of the image. < Beginner >		Ver. 1.03	
	Decimation Selector	decimationSelector	Select how Horizontal and Vertical Decimation is done. The Decimation function can operate in the Digital domain of a device or directly at the sensor. < Beginner >	—	—	Ver. 1.06
	<i>In Sensor</i>	<i>InSensor</i>	<i>The Decimation function operates directly in the Sensor, thus reducing the pixel count from the sensor and camera.</i>			
	<i>In Digital Domain</i>	<i>InDigitalDomain</i>	<i>The Decimation function operates in the device with a digital processing function. Decimation doesn't affect the current data rate from the sensor or camera.</i>			
	Decimation Horizontal	DecimationHorizontal	Horizontal sub-sampling of the image. This reduces the horizontal resolution of the image by the specified horizontal decimation factor. For example, when set to 2, every second pixel is discarded. < Beginner >			Ver. 1.06
	Decimation Vertical	DecimationVertical	Vertical sub-sampling of the image. This reduces the vertical resolution of the image by the specified vertical decimation factor. For example, when set to 2, every second line is discarded. < Beginner >			Ver. 1.06
	Test Image Selector	TestImageSelector	Selects the type of test image generated by the camera. < Beginner >			
	<i>Off</i>	<i>Off</i>	<i>Image is from the camera sensor.</i>			

	Grey Horizontal Ramp	GreyHorizontalRamp	Image is filled horizontally with an image that goes from the darkest possible value to the brightest.			
	Grey Vertical Ramp	GreyVerticalRamp	Image is filled vertically with an image that goes from the darkest possible value to the brightest.			
	Grey Diagonal Ramp Moving	GreyDiagonalRampMoving	Image is filled horizontally with an image that goes from the darkest possible value to the brightest by 1 Dn increment per pixel and that moves horizontally.			
	Width Max	WidthMax	The maximum image width is the dimension calculated after horizontal binning, decimation or any other function changing the horizontal dimension of the image. < RO, Invisible >			
	Height Max	HeightMax	The maximum image height is the dimension calculated after vertical binning, decimation or any other function changing the vertical dimension of the image. < RO, Invisible >			
	Pixel Coding	PixelCoding	Output image pixel coding format of the sensor. < RO, Invisible >			
	Mono	Mono	Pixel is monochrome			
	MonoSigned	MonoSigned	Pixel is monochrome and signed			
	MonoPacked	MonoPacked	Pixel is monochrome and packed			
	Raw Bayer	Raw	Pixel is raw Bayer			
	BGR8 Packed	BGR8Packed	Pixel is BGR 24-bit		1.05 RGB Design	
	BGRA Packed	BGRA8Packed	Pixel is BGRA 32-bit		1.05 RGB Design	
	YUV422 Packed	YUV422Packed	Pixel is YUV422 16-bit UYVY		1.05 RGB Design	
	YUYV Packed	YUYVPacked	Pixel is YUV422 16-bit YUYV		1.05 RGB Design	
	Pixel Color Filter	PixelColorFilter	Indicates the type of color filter applied to the image. < RO, Invisible >			
	None	None	No filter applied on the sensor.			
	Bayer GR	BayerGR	For BayerGR, the 2x2 mosaic alignment is GR/BG.			
	Bayer RG	BayerRG	For BayerRG, the 2x2 mosaic alignment is RG/GB.			
	Bayer GB	BayerGB	For BayerGB, the 2x2 mosaic alignment is GB/RG.			
	Bayer BG	BayerBG	For BayerBG, the 2x2 mosaic alignment is BG/GR.			

Width and Height Features for Partial Scan Control

Width and Height controls along with their respective offsets, allow the Genie Nano to grab a region of interest (ROI) within the full image frame. Besides eliminating post acquisition image cropping done by software in the host computer, a windowed ROI grab reduces the bandwidth required on the Gigabit Ethernet link since less pixels are transmitted.

Vertical Cropping (Partial Scan)

The Height and Vertical Offset features, used for vertical cropping, reduce the number of video lines grabbed for a frame. By not scanning the full height of the sensor, the maximum possible acquisition frame rate is proportionately increased, up to the Genie Nano model maximum.

The following figure is an example of a partial scan acquisition using both Height and Vertical Offset controls. The Vertical Offset feature defines at what line number from the sensor origin to acquire the image. The Height feature defines the number of lines to acquire (to a maximum of the remaining frame height). Note that only the partial scan image (ROI) is transmitted to the host computer.

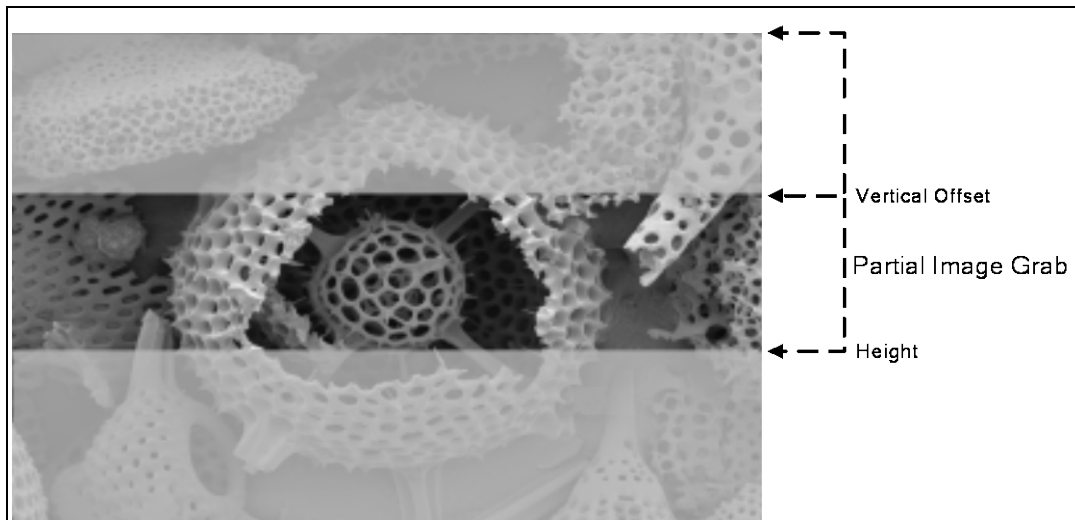

Partial Scan Illustration



Note: In general, using short exposures at high frame rates will exceed the maximum bandwidth to host transfer speed, when the camera buffer memory is filled. The tables below (for different Genie Nano models) describe frame rate maximums written to internal memory that can be sustained during continuous acquisition. Increase the exposure time, decrease the frame rate, [enable TurboDrive](#), or acquire a limited number of frames, so as to not exceed the transfer bandwidth.

Maximum Frame Rate Examples (Models M/C 1920 & 1940)

Vertical Lines Acquired	Internal Trigger / Minimum Exposure Sony sensor – M/C1920 Models	Internal Trigger / Minimum Exposure Sony sensor – M/C1940 Models
1216	38 fps	83 fps
1080	43 fps	94 fps
900	51 fps	111 fps
600	75 fps	163 fps
450	98 fps	212 fps
300	141 fps	304 fps
150	249 fps	539 fps
74	409 fps	884 fps
32	632 fps	1366 fps
16	799 fps	1724 fps

Maximum Frame Rate Examples (Models M2420 & M2450)

Vertical Lines Acquired	Internal Trigger Minimum Exposure Sony sensor – M2420 Models	Internal Trigger Minimum Exposure Sony sensor – M2450 Models Standard Design Firmware	Internal Trigger Minimum Exposure Sony sensor – M2450 Models High Sensitivity Design
2048	34 fps	76 fps	94 fps
1536	45 fps	101 fps	124 fps
1024	68 fps	150 fps	184 fps
768	90 fps	198 fps	242 fps
512	132 fps	290 fps	355 fps
384	173 fps	379 fps	463 fps
256	251 fps	543 fps	664 fps
128	454 fps	963 fps	1177 fps
64	763 fps	1567 fps	1915 fps
32	1158 fps	2283 fps	2793 fps
16	1560 fps	2958 fps	3623 fps
8	1890 fps	3472 fps	4237 fps
4	2109 fps	3802 fps	4651 fps

Maximum Frame Rate Examples (Models M2020 & M2050)

Vertical Lines Acquired	Internal Trigger Minimum Exposure Sony sensor – M2020 Models	Internal Trigger Minimum Exposure Sony sensor – M2050 Models Standard Design Firmware	Internal Trigger Minimum Exposure Sony sensor – M2050 Models High Sensitivity Design
1536	53 fps	116.6 fps	143 fps
1024	79 fps	173.8 fps	213 fps
768	105 fps	228.9 fps	280 fps
512	154 fps	335.4 fps	411 fps
384	202 fps	437.2 fps	536 fps
256	293 fps	627.7 fps	769 fps
128	530 fps	1111 fps	1362 fps
64	892 fps	1808 fps	2217 fps
32	1353 fps	2631 fps	3225 fps
16	1821 fps	3412 fps	4184 fps
8	2207 fps	4000 fps	4901 fps
4	2463 fps	4386 fps	5376 fps

Maximum Frame Rate Examples (Models M/C 4040 & 4060)

Increased frame rates with a reduced ROI available only when In-Sensor binning is not active.

Vertical Lines Acquired	Internal Trigger / Minimum Exposure Sony sensor – M/C4040 Models	Internal Trigger / Minimum Exposure Sony sensor – M/C4060 Models
3008	33.6 fps	—
2176	46.1 fps	46.1 fps
2048	48.9 fps	48.9 fps
1024	95.4 fps	95.4 fps
512	181.7 fps	181.7 fps
256	331.8 fps	331.8 fps
128	564.6 fps	564.6 fps
64	871.0 fps	871.0 fps
32	1194.7 fps	1194.7 fps
16	1468.4 fps	1468.4 fps
8	1658.3 fps	1658.3 fps
4	1773.0 fps	1773.0 fps

Maximum Frame Rate Examples (Models M/C 4020 & 4030)

Vertical Lines Acquired	Internal Trigger / Minimum Exposure Sony sensor – M/C4020 Models	Internal Trigger / Minimum Exposure Sony sensor – M/C4030 Models
3008	14.6 fps	—
2176	20.1 fps	20.1 fps
2048	21.4 fps	21.4 fps
1024	42.1 fps	42.1 fps
512	81.5 fps	81.5 fps
256	153.2 fps	153.2 fps
128	273.6 fps	273.6 fps
64	450.2 fps	450.2 fps
32	665.3 fps	665.3 fps
16	873.3 fps	873.3 fps
8	1037.3 fps	1037.3 fps
4	1142.8 fps	1142.8 fps

Maximum Frame Rate Examples (Model M/C 2590)

Vertical Lines Acquired	Internal Trigger / Minimum Exposure OnSemi sensor – M/C2590 Models	Internal Trigger / Minimum Exposure OnSemi sensor – M/C2590 Models Fast Readout Mode Enabled
2048	42 fps	51 fps
1536	56 fps	69 fps
1024	85 fps	102 fps
768	112 fps	136 fps
512	167 fps	202 fps
256	325 fps	391 fps
128	616 fps	734 fps
64	1114 fps	1310 fps
32	1869 fps	2150 fps
16	2832 fps	3174 fps
8	3802 fps	4149 fps
4	4608 fps	4926 fps
2	5128 fps	5405 fps

Note: Fast Readout Mode will have low DN Fixed Pattern column artifacts as described here [OnSemi Sensor Fast Readout Mode](#).

Maximum Frame Rate Examples (Model C 4900)

Vertical Lines Acquired	Internal Trigger / Minimum Exposure Aptina sensor – C4900 Model
3684	13.38 fps
2762	17.76 fps
1842	26.36 fps
1024	46.19 fps
768	60.45 fps
512	87.46 fps
256	158.0 fps
128	265.0 fps
64	400.6 fps
32	538.5 fps
16	650.1 fps
8	725.1 fps
4	769.8 fps

Maximum Frame Rate Examples (Model M/C 1930)

Vertical Lines Acquired	Internal Trigger / Minimum Exposure OnSemi sensor – M/C1930 Models	Internal Trigger / Minimum Exposure OnSemi sensor – M/C1930 Models Fast Readout Mode Enabled
1200	91 fps	116 fps
1024	106 fps	136 fps
768	141 fps	180 fps
512	209 fps	266 fps
256	403 fps	510 fps
128	755 fps	941 fps
64	1337 fps	1628 fps
32	2174 fps	2564 fps
16	3164 fps	3597 fps
8	4098 fps	4504 fps
4	4807 fps	5154 fps
2	5263 fps	5555 fps

Note: Fast Readout Mode will have low DN Fixed Pattern column artifacts as described here [OnSemi Sensor Fast Readout Mode](#).

Maximum Frame Rate Examples (Model M/C 1240)

Vertical Lines Acquired	Internal Trigger / Minimum Exposure OnSemi P3 sensor
1024	87.29 fps
768	115.9 fps
512	172.5 fps
256	337.2 fps
128	645.1 fps
64	1187 fps
32	2049 fps
16	3215 fps
8	4484 fps
4	5586 fps
2	6369 fps

Maximum Frame Rate Examples (Model M/C 1280)

Vertical Lines Acquired	Internal Trigger / Minimum Exposure OnSemi sensor – M/C1280 Models	Internal Trigger / Minimum Exposure OnSemi sensor – M/C1280 Models Fast Readout Mode Enabled
1024	174 fps	213 fps
768	231 fps	283 fps
512	345 fps	421 fps
256	674 fps	821 fps
128	1287 fps	1557 fps
64	2364 fps	2824 fps
32	4065 fps	4761 fps
16	6369 fps	7246 fps
8	8849 fps	9803 fps
4	10989 fps	11904 fps
2	12500 fps	13333 fps

Note: Fast Readout Mode will have low DN Fixed Pattern column artifacts as described here [OnSemi Sensor Fast Readout Mode](#).

Maximum Frame Rate Examples (Models M/C 1450)

Vertical Lines Acquired	Internal Trigger / Minimum Exposure Synchronous Exposure	Internal Trigger / Minimum Exposure Reset Exposure
1088	161.0	161.3
768	224.7	225.2
512	328.7	330.0
256	611.9	616.1
128	1075.2	1089.3
64	1730.1	1766.7
32	2487.5	2564.1
16	3184.7	3311.2
8	3703.7	3875.9
4	4032.2	4237.2

Maximum Frame Rate Examples (Model M/C 800)

Vertical Lines Acquired	Internal Trigger / Minimum Exposure OnSemi sensor – M/C800 Models	Internal Trigger / Minimum Exposure OnSemi sensor – M/C800 Models Fast Readout Mode Enabled
600	419 fps	566 fps
480	520 fps	701 fps
240	1004 fps	1340 fps
128	1776 fps	2331 fps
64	3164 fps	4048 fps
32	5181 fps	6369 fps
16	7633 fps	9009 fps
8	10000 fps	11236 fps
4	11904 fps	12987 fps
2	12987 fps	13888 fps

Note: Fast Readout Mode will have low DN Fixed Pattern column artifacts as described here [OnSemi Sensor Fast Readout Mode](#).

Maximum Frame Rate Examples (Model M/C 640)

Vertical Lines Acquired	Internal Trigger / Minimum Exposure OnSemi sensor – M/C640 Models	Internal Trigger / Minimum Exposure OnSemi sensor – M/C640 Models Fast Readout Mode Enabled
480	603 fps	862 fps
240	1160 fps	1631 fps
128	2032 fps	2801 fps
64	3558 fps	4716 fps
32	5714 fps	7194 fps
16	8196 fps	9803 fps
8	10526 fps	11904 fps
4	12195 fps	13333 fps
2	13157 fps	14285 fps

Note: Fast Readout Mode will have low DN Fixed Pattern column artifacts as described here [OnSemi Sensor Fast Readout Mode](#).

Maximum Frame Rate Examples (NanoXL M5100)

Using High Speed Firmware (8-bit only)

Vertical Lines Acquired	Internal Trigger / Minimum Exposure Python 25k sensor – model M5100	Internal Trigger / Minimum Exposure Python 25k sensor – model M5100 Fast Readout Mode Enabled
5120	11.8	20.4
3840	15.7	27.2
2560	23.5	40.7
1280	46.9	80.9
640	93.2	160.5
320	184.1	315.2
160	359.1	608.3
80	684.9	1137.7
40	1253.1	2012.1
20	2141.3	3267.9
10	3322.2	4761.9
5	4566.2	6134.9

Note: Fast Readout Mode will have low DN Fixed Pattern column artifacts as described here [OnSemi Sensor Fast Readout Mode](#).

Using Standard Firmware

Vertical Lines Acquired	Internal Trigger / Minimum Exposure Python 25k sensor – model M5100	Internal Trigger / Minimum Exposure Python 25k sensor – model M5100 Fast Readout Mode Enabled
5120	5.9 fps	10.2 fps
3840	7.8 fps	13.6 fps
2560	11.8 fps	20.4 fps
1280	23.5 fps	40.6 fps
640	46.8 fps	80.7 fps
320	92.7 fps	159.5 fps
160	182.1 fps	311.4 fps
80	351.6 fps	594.5 fps
40	657.9 fps	1089.3 fps
20	1165.5 fps	1865.6 fps
10	1901.1 fps	2907 fps
5	2770 fps	4016 fps

Maximum Frame Rate Examples (NanoXL M4090)

Using High Speed Firmware (8-bit only)

Vertical Lines Acquired	Internal Trigger / Minimum Exposure Python 16k sensor –model M4090	Internal Trigger / Minimum Exposure Python 16k sensor – model M4090 Fast Readout Mode Enabled
4096	16.5	31.2
3840	17.6	33.4
2560	26.3	49.9
1280	52.5	99.3
640	104.2	196.3
320	205.5	384.0
160	400.0	735.8
80	758.7	1356.8
40	1375.5	2347.4
20	2320.2	3703.7
10	3521.1	5181.3
5	4761.9	6493.5

Note: Fast Readout Mode will have low DN Fixed Pattern column artifacts as described here [OnSemi Sensor Fast Readout Mode](#).

Using Standard Firmware

Vertical Lines Acquired	Internal Trigger / Minimum Exposure Python 16k sensor –model M4090	Internal Trigger / Minimum Exposure Python 16k sensor – model M4090 Fast Readout Mode Enabled
4096	8.2	15.6
3840	8.8	16.7
2560	13.2	25.0
1280	26.3	49.8
640	53.3	98.2
320	103.6	194.9
160	203.0	378.5
80	390.6	715.3
40	725.7	1288.6
20	1272.2	2155.1
10	2036.6	3236.2
5	2915	4329

Horizontal Cropping (Partial Scan)

Genie Nano supports cropping the acquisition horizontally by grabbing less pixels on each horizontal line. Horizontal offset defines the start of the acquired video line while horizontal width defines the number of pixels per line. Horizontal control features have the following independent constants:

- Horizontal Offset is limited to pixel increment values of 4 to define the start of the video line.
- Horizontal Width decrements from maximum in pixel counts of 8 (i.e. the video width is in steps of 8 pixels).

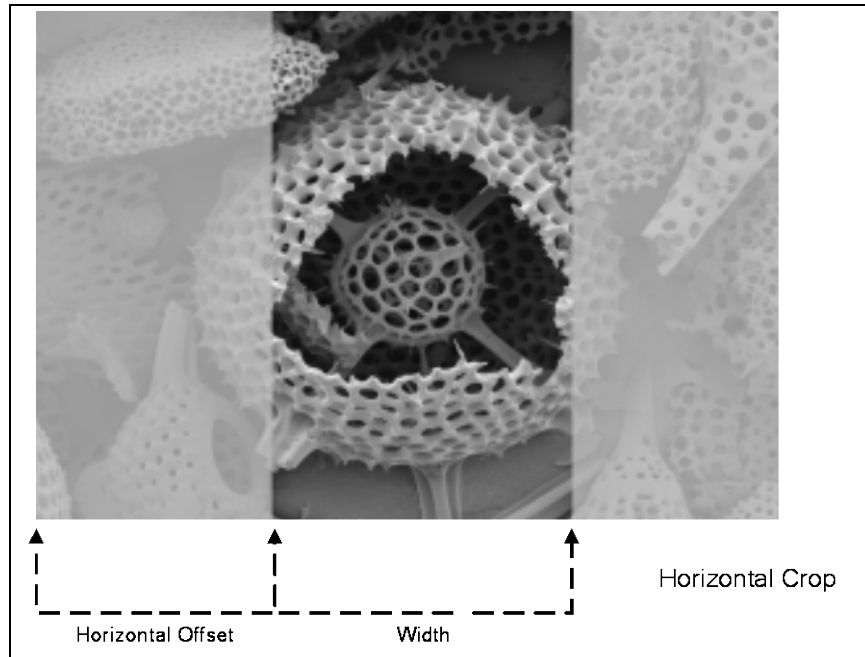

Using the Multiple ROI Mode

Genie Nano monochrome cameras implement the Multiple ROI mode (region of interest) features, which allow having 2 to 16 smaller image ROI areas versus the single ROI area possible with vertical and horizontal crop functions.

These multiple areas are combined as one output image, reducing transfer bandwidth requirements, plus with the added benefit that any reduction of the number of vertical lines output will result in a greater possible camera frame rate. This increased frame rate increase (written to internal memory) is similar to using the vertical crop feature.

Important Usage Details

- Two to 16 ROI areas are supported by the Genie Nano (4x4 matrix maximum).
- For any selected ROI, the Offset X/Offset Y features define the upper left corner of the ROI.
- Offset, Width, and Height features have individual increment values (step size) to consider.
- The first ROI of any row sets the “height value” for any other ROI in that row.
- The first ROI of any column sets the “width value” of any other ROI in that column.
- Note that the Nano firmware by default provides a 4x4 sample multi-ROI setup for easy verification of this function.

The following graphics show examples of the multi-ROI function (2x1 and 2x2 areas), the resultant camera output, and the constraints when configuring the ROI areas.

Example: Two Horizontal ROI Areas (2x1)

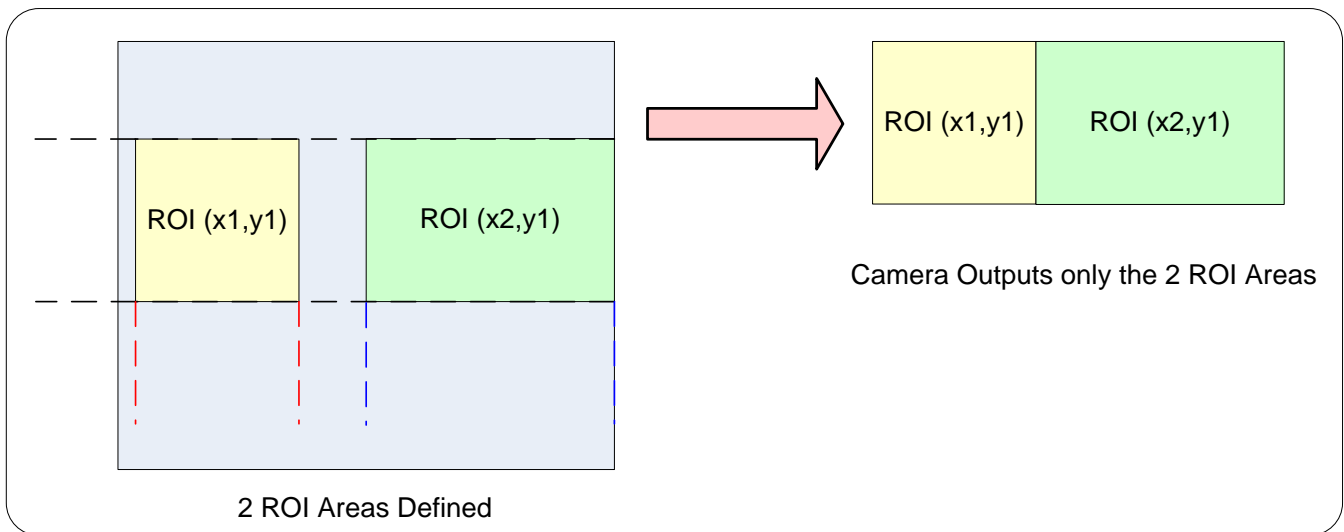

- Note that ROI(x1, y1) defines the height of any ROI in that row.
- ROI(x2, y1) can have a different width.
- The camera output image frame consists only of the two ROI areas. The user must account for the change between ROI data for each output image row.
- The output image being smaller, reduces the bandwidth requirements.

Example: Four ROI Areas (2x2)

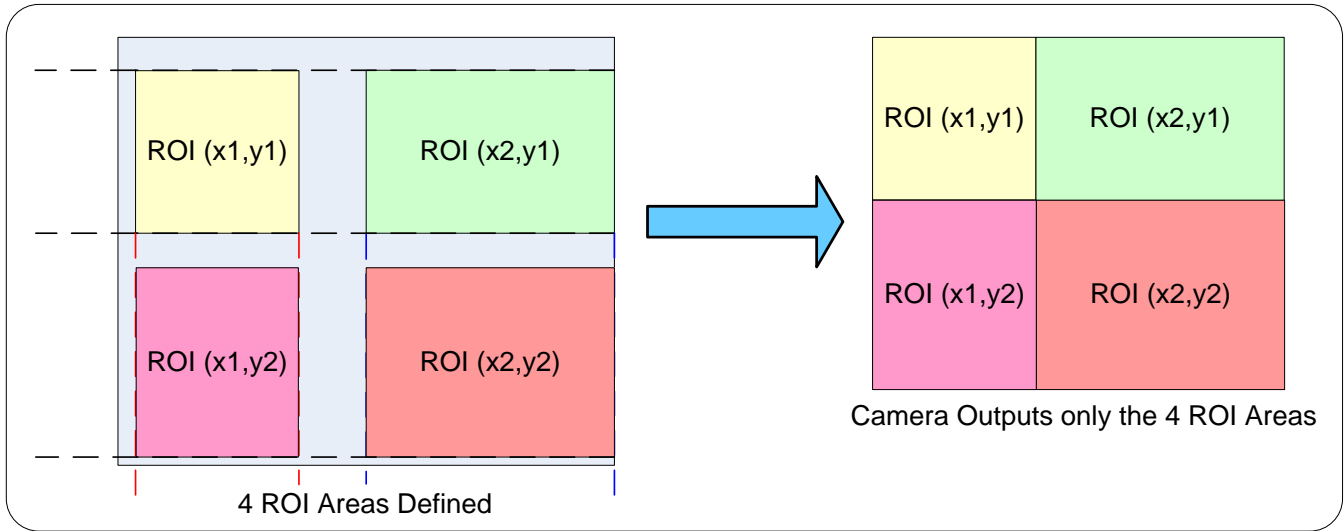

- Note that ROI(x1, y1) defines the height of any ROI in that row.
- ROI(x2, y1) can have a different width.
- ROI(x1, y2) can have a different height relative to ROI(x1,y1).
- The camera output image frame consists only of the ROI areas, in the same order as the ROI rows and columns. The user must account for the change between ROI data for each output image row.
- The output image being smaller, reduces the bandwidth requirements.

Example: Actual Sample with Six ROI Areas (3x2)

This example uses the example problem of solder inspection of certain components on a PCB. The image below of a sample PCB shows 6 ROI areas highlighted by the yellow overlay graphics (manually added to this example).

Note how the top row ROI areas may be larger than ideal due to height and width requirements of ROI areas in the second row; constraints and interdependencies as defined in the preceding ROI descriptions.

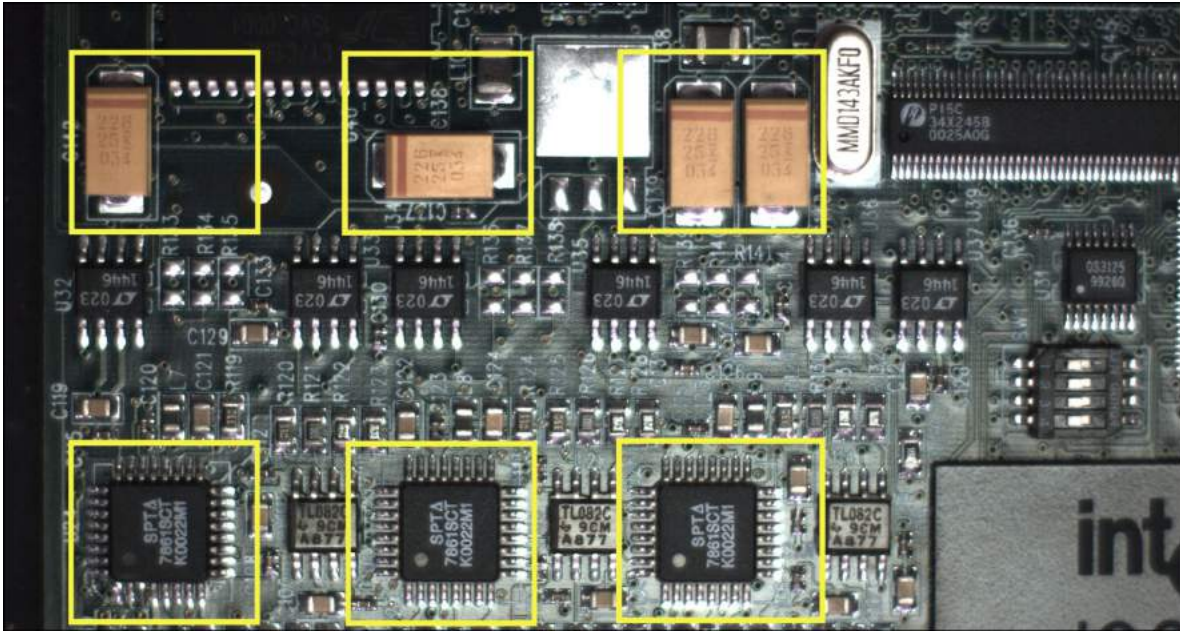

With the ROI areas defined, the camera outputs an image consisting only of data within those ROI areas, as shown below. Such data reduction improves transfer bandwidth and also reduces image processing time for the host system imaging application.

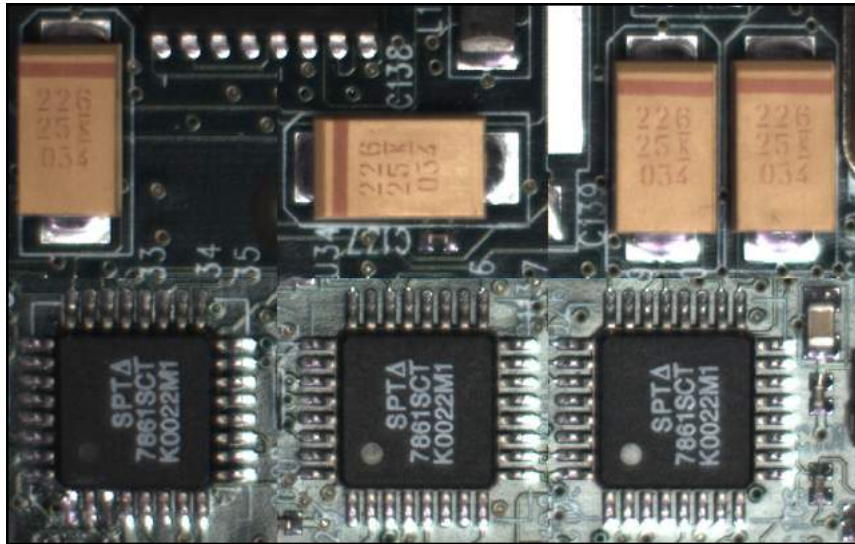

Horizontal and Vertical Flip

The Image Flip features activate image acquisition with horizontal and/or vertical inversion.

- Support of one or both of these functions is Genie Nano model specific since it is a function of sensor data readout, not post sensor processing (thus internal test images cannot be flipped).
- When image flip is supported directly at the sensor, activation of the flip function does not reduce the maximum frame rate possible from that model of Nano.
- The Image flip functions operate both on full image acquisitions and when using multi-ROI. Both modes are described below.

Image Flip – Full Frame

With full frame acquisitions, live horizontal and/or vertical image flips function as expected.

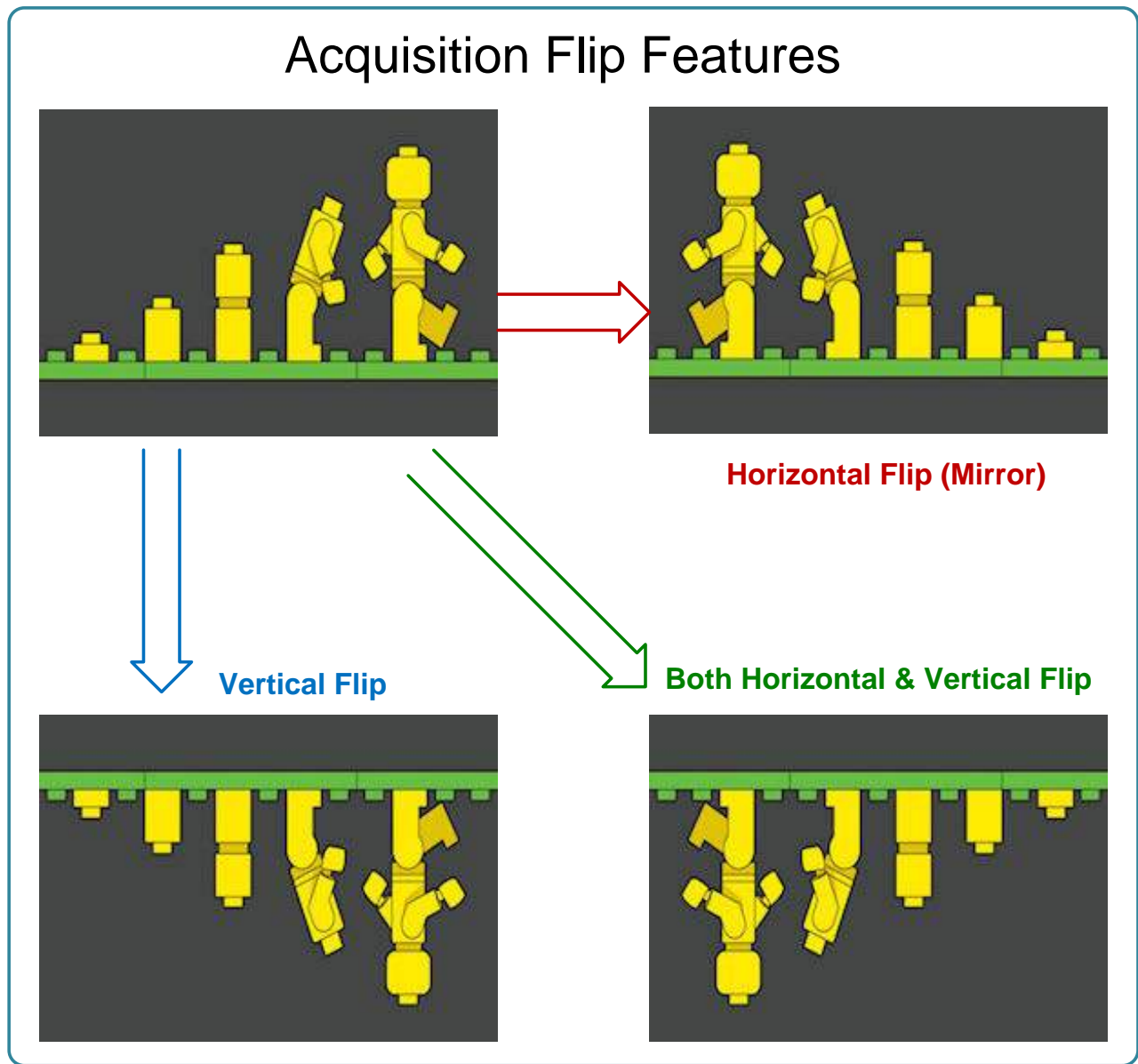
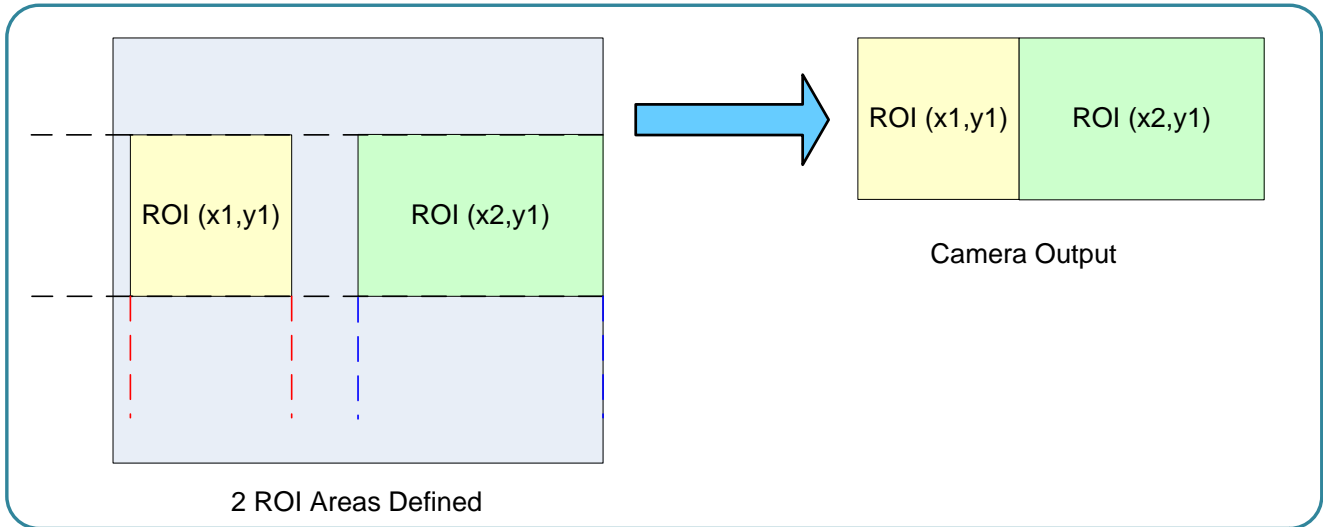

Image Flip – Multi-ROI Mode

Image acquisition flips with multi-ROI enabled is implemented as follows:

- The first graphic below shows a simple multi-ROI of two areas, where the camera output is composed of only those two areas.
- As shown in the second graphic, the multi-ROI implementation resizes the programmed ROI areas so that the same exact image areas are output by the camera but flipped as expected.
- Note that the ROI indexes do not transpose—just their size and offsets.
- All multi-ROI setup constraints remain as described in the previous section describing the Multi-ROI mode.



Horizontal Flip with Multi-ROI

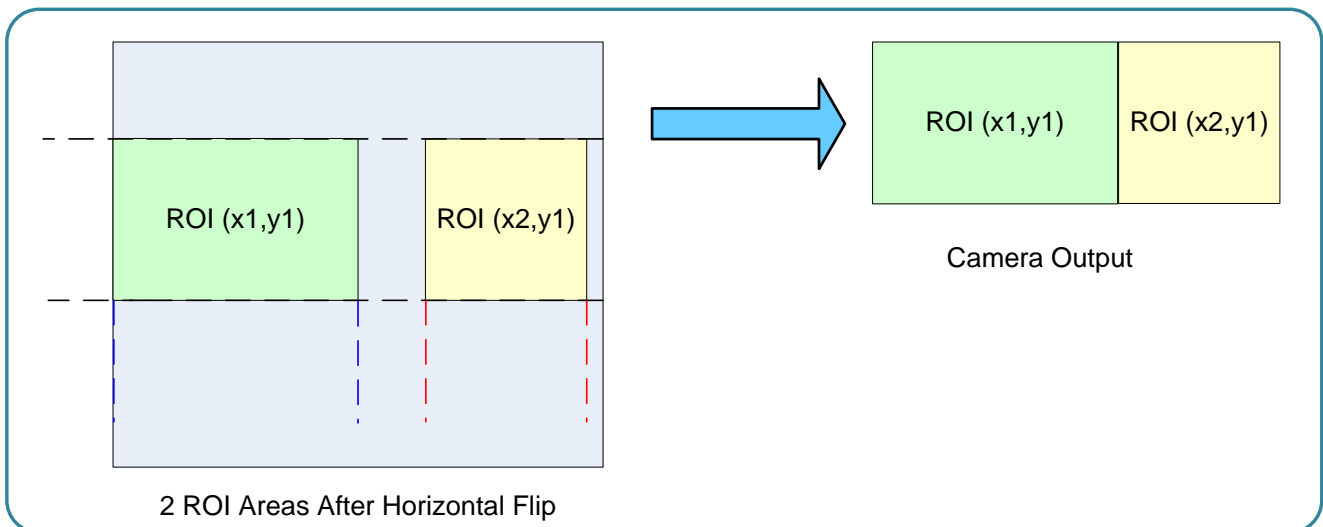

Binning Function and Limitations

Binning is the process where the charge on two (or more) adjacent pixels is combined. This results in increased light sensitivity since there is twice the sensor area to capture photons. The sensor spatial resolution is reduced but the improved low-light sensitivity plus lower signal-noise ratio may solve a difficult imaging situation. The user can evaluate the results of the binning function on the Genie Nano by using CamExpert.

Horizontal and vertical binning functions are independent, by factors of 2 or 4 in each axis. Specifically if horizontal binning only is activated, a nominal 640x480 image is reduced to 320x480. If vertical binning only is activated, the image is reduced to 640x240. With both binning modes activated, the resulting image is 320x240.

Binning is performed digitally, therefore there is no increase in acquisition frame rate. The following graphic illustrates binning.

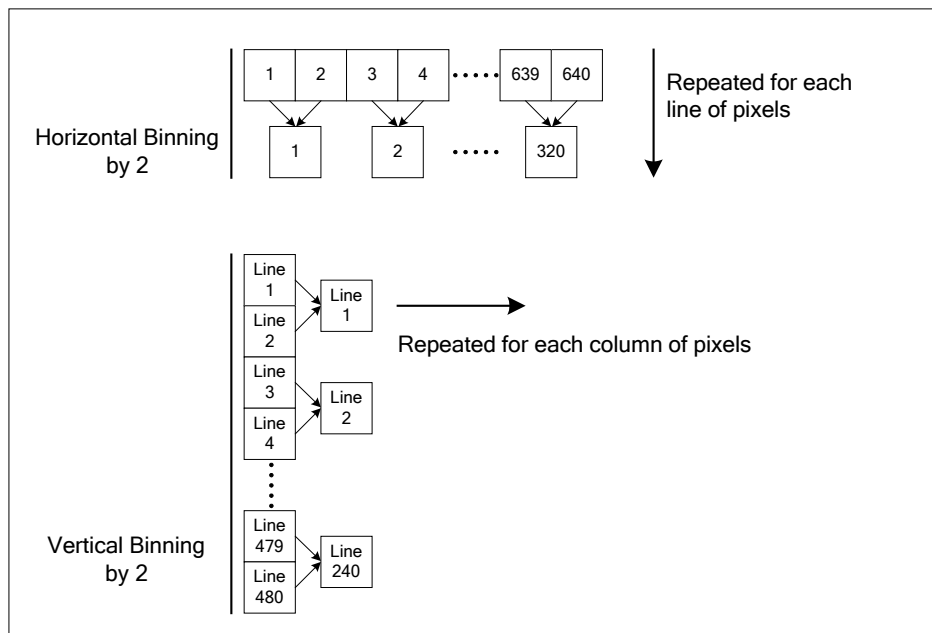

Horizontal and Vertical Binning Illustration

Horizontal Binning Constraints

- Horizontal Binning of 2 requires a minimum frame width of 128 pixels or more.
- Horizontal Binning of 4 requires a minimum frame width of 256 pixels or more.

Vertical Binning Constraints

- Vertical Binning of 4 is available if the image height before binning is a multiple of 4 lines.
- Vertical Binning of 2 is available if the image height before binning is a multiple of 2 lines.

Internal Test Pattern Generator

The Genie Nano camera includes a number of internal test patterns which easily confirm camera installations, without the need for a camera lens or proper lighting.

Use CamExpert to easily enable and select the any of the Nano test patterns from the drop menu while the camera is not in acquisition mode. Select live grab to see the pattern output.

Note that internal test patterns are generated by the camera FPGA where the patterns are inserted immediately after the sensor output in the processing chain and are the same maximum bit depth as the sensor. The patterns are identical for monochrome or color camera models and subject to processing operations.

- Note: Selecting the camera 8-bit output format displays the lower 8-bits of the processing path.

The Nano Test Patterns are:

- **Grey Horizontal ramp:** *Image is filled horizontally with an image that goes from the darkest possible value to the brightest.*



- **Grey Vertical ramp:** *Image is filled vertically with an image that goes from the darkest possible value to the brightest.*



- **Grey Diagonal Ramp Moving:** combination of the 2 previous schemes, but first pixel in image is incremented by 1 between successive frames. This is a good pattern to indicate motion when doing a continuous grab.



Important: When an internal Nano Test Image is selected, the [Metadata feature values](#) for Exposure Time and Exposure Delay are not valid values and must be ignored.

Metadata Control Category

The Genie Nano Metadata controls as shown by CamExpert, has features to enable and select inclusion of chunk data with the image payload (as specified by the specification GigE Vision 1.2).

Parameters in gray are read only, either always or due to another parameter being disabled. Parameters in black are user set in CamExpert or programmable via an imaging application.

Note: Metadata and Turbo Drive features are available with firmware 1.07 and later. Sopera LT 8.31 is required (or GigE Vision driver 5.10).

Limitation: Metadata and Turbo Drive feature availability are currently mutually exclusive with camera firmware versions 1.00 to 1.06.

Features listed in the description table but tagged as *Invisible* are usually for Teledyne DALSA or third party software usage—not typically needed by end user applications. Also important, Genie Nano cameras are available in a number of models implementing different sensors and image resolutions which may not support the full feature set defined in this category.

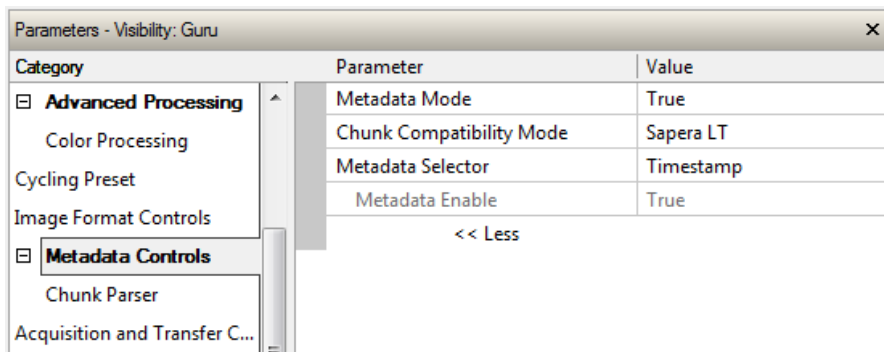

Metadata Control Category Feature Descriptions

The following table describes these parameters along with their view attribute and minimum camera firmware version required. Additionally the Device Version column will indicate which parameter is a member of the Teledyne DALSA Features Naming Convention (denoted by DFNC), versus the GenICam Standard Features Naming Convention (SFNC not shown).

Teledyne DALSA provides header files for developers managing Genie Nano LUT data and chunk payload data as supported by GigE Vision 1.2. Refer to section following the table of metadata features.

The Device Version number represents the camera software functional group, not a firmware revision number. As Genie capabilities evolve the device version tag will increase, therefore identifying the supported function package. New features for a major device version release will be indicated by **green text** for easy identification.

Display Name	Feature & Values	Description	Device Version & View	
Metadata Mode	ChunkModeActive	Activates the inclusion of chunk data (metadata) in the payload of the image.	1.01 Expert	
	<i>False</i>	<i>No chunk data.</i>		
	<i>True</i>	<i>Chunk data included in payload</i>		
Chunk Compatibility Format	chunkCompatibilityMode	Selects the format of the chunk data (metadata) in the payload of the image.	1.04 Expert DFNC	
	<i>Sapera LT</i>	<i>SaperaLT</i>		<i>Metadata compatible with Teledyne DALSA Sapera LT 8.0.</i>
	<i>Gen API</i>	<i>GenAPI</i>		<i>Metadata compatible with GenICam GenAPI.</i>
Metadata Selector	ChunkSelector	Selects the specific metadata to control, when enabled.	1.04 Expert	
	OffsetX	Add the OffsetX value used during the image acquisition to the metadata attached to the image		
	OffsetY	Add the OffsetY value used during the image acquisition to the metadata attached to the image.		
	<i>Width</i>	Add the Width value used during the image acquisition to the metadata attached to the image.		
	<i>Height</i>	Add the Height value used during the image acquisition to the metadata attached to the image.		
	<i>PixelFormat</i>	Add the PixelFormat value used during the image acquisition to the metadata attached to the image.		
	<i>ExposureTime</i>	Add the ExposureTime value used during the image acquisition to the metadata attached to the image.		
	<i>ExposureDelay</i>	Add the ExposureDelay value used during the image acquisition to the metadata attached to the image. Supported only in GenAPI compatibility mode. (N/A for C4900 – 1.06)		
	<i>cyclingPresetCurrentActiveSet</i>	Add the cyclingPresetCurrentActiveSet value used during the image acquisition to the metadata attached to the image.		
	<i>Timestamp</i>	Copies the timestampValue value at the start of exposure to the metadata attached to the image.		
	<i>LineStatusAll</i>	Copies the LineStatusAll value at the start of exposure to the metadata attached to the image.		
	<i>Gain</i>	Add the Gain feature value used during the image acquisition to the metadata attached to the image.		
	<i>Counter1ValueAtReset</i>	Copies the value of the feature "counterValueAtReset" at the start of Frame Readout, to the Metadata attached to the image. Supported only in GenAPI compatibility mode.		
	<i>DeviceID</i>	Add the DeviceID value to the metadata attached to the image.		
	<i>DeviceUserID</i>	Add the DeviceUserID value to the metadata attached to the image.		
	<i>TestImageSelector</i>	Add the TestImageSelector value used during the image acquisition to the metadata attached to the image.		
<i>BinningVertical</i>	Add the BinningVertical value used during the image acquisition to the metadata attached to the image. <ver. 1.03>			
<i>BinningHorizontal</i>	Add the BinningHorizontal value used during the image acquisition to the metadata attached to the image. <ver. 1.03>			
Metadata Enable	ChunkEnable	Sets the enable state of the selected metadata. When enabled, the metadata is included in the payload of the image.	1.01 Expert	
	<i>False</i>	<i>Selected metadata Disabled</i>		
	<i>True</i>	<i>Selected metadata Enabled</i>		

Chunk Exposure Time	ChunkExposureTime	Returns the exposure time used to capture the image.	1.04 Guru
Chunk Cycling Preset Current Active Set	ChunkCyclingPresetCurrentActiveSet	Returns the index of the cycling preset used for this image.	1.04 Guru
Chunk Line Status All	ChunkLineStatusAll	Returns the status of all available line signals, when the image was exposed. The order is Line1, Line2,	1.04 Guru
Chunk Gain Selector	ChunkGainSelector	Selects which gain is read by the ChunkGain feature.	1.04 Guru
<i>Digital</i>	<i>DigitalAll</i>	<i>Apply a digital gain adjustment to the entire image. This independent gain factor is applied to the image after the sensor.</i>	
<i>Sensor</i>	<i>SensorAll</i>	<i>This gain is applied to the image by the sensor.</i>	
Chunk Gain	ChunkGain	The selected gain value used for the image included in the payload.	1.04 Guru
Chunk Horizontal Offset	ChunkOffsetX	Horizontal offset from the Sensor Origin to the Region Of Interest (in pixels).	1.04 Guru
Chunk Vertical Offset	ChunkOffsetY	Vertical offset from the Sensor Origin to the Region Of Interest (in lines).	1.04 Guru
Chunk Width	ChunkWidth	Image Width (in pixels) included in the payload.	1.04 Guru
Chunk Height	ChunkHeight	Image Height (in lines) included in the payload.	1.04 Guru
Chunk Timestamp Value	ChunkTimestamp	Returns the 64-bit Timestamp value for the image included in the payload.	1.04 Guru
Chunk Binning Horizontal	ChunkBinningHorizontal	Number of horizontal pixels to combine in the payload image.	1.04 Guru
Chunk Binning Vertical	ChunkBinningVertical	Number of vertical pixels to combine in the payload image.	1.04 Guru
Chunk Test Image Selector	ChunkTestImageSelector	The selected test image included in the payload.	1.04 Guru
<i>Off</i>	<i>Off</i>	<i>Image is from the camera sensor.</i>	
<i>Grey Horizontal Ramp</i>	<i>GreyHorizontalRamp</i>	<i>Image is filled horizontally with an image that goes from the darkest possible value to the brightest.</i>	
<i>Grey Vertical Ramp</i>	<i>GreyVerticalRamp</i>	<i>Image is filled vertically with an image that goes from the darkest possible value to the brightest.</i>	
<i>Grey Diagonal Ramp Moving</i>	<i>GreyDiagonalRampMoving</i>	<i>Image is filled horizontally and vertically with an image that goes from the darkest possible value to the brightest by 1 DN increment per pixel and that moves horizontally from right to left at each frame by one pixel.</i>	
Chunk Serial Number	ChunkDeviceID	Displays the factory set serial number of the device.	1.04 Guru
Chunk Device User ID	ChunkDeviceUserID	Returns the user define name of the camera.	1.04 Guru
Chunk Pixel Format	ChunkPixelFormat	Pixel format of payload image.	1.04 Guru
<i>Monochrome 8-Bit</i>	<i>Mono8</i>	<i>Mono8: Monochrome 8-Bit</i>	
<i>Monochrome 10-Bit</i>	<i>Mono10</i>	<i>Mono10: Monochrome 10-Bit</i>	
<i>Monochrome 12-Bit</i>	<i>Mono12</i>	<i>Mono12: Monochrome 12-Bit</i>	
<i>BayerGR8 8-bit</i>	<i>BayerGR8</i>	<i>Color camera: BayerGR8</i>	
<i>BayerRG8 8-bit</i>	<i>BayerRG8</i>	<i>Color camera: BayerRG8</i>	
<i>BayerGB8 8-bit</i>	<i>BayerGB8</i>	<i>Color camera: BayerGB8</i>	
<i>BayerBG8 8-bit</i>	<i>BayerBG8</i>	<i>Color camera: BayerBG8</i>	
<i>BayerGR10 10-bit</i>	<i>BayerGR10</i>	<i>Color camera: BayerGR10</i>	

<i>BayerRG10 10-bit</i>	<i>BayerRG10</i>	<i>Color camera: BayerRG10</i>	
<i>BayerGB10 10-bit</i>	<i>BayerGB10</i>	<i>Color camera: BayerGB10</i>	
<i>BayerBG10 10-bit</i>	<i>BayerBG10</i>	<i>Color camera: BayerBG10</i>	
<i>BayerGR12 12-bit</i>	<i>BayerGR12</i>	<i>Color camera: BayerGR12</i>	
<i>BayerRG12 12-bit</i>	<i>BayerRG12</i>	<i>Color camera: BayerRG12</i>	
<i>BayerGB12 12-bit</i>	<i>BayerGB12</i>	<i>Color camera: BayerGB12</i>	
<i>BayerBG12 12-bit</i>	<i>BayerBG12</i>	<i>Color camera: BayerBG12</i>	
<i>BGR 8-Bit Packed</i>	<i>BGR8</i>	<i>Color camera: BGR8</i>	
<i>BGRA 8-Bit Packed</i>	<i>BGRA8</i>	<i>Color camera: BGRA8</i>	
<i>YUV422_8_YUYV</i>	<i>YUV422_8</i>	<i>Color camera: YUV422_8_YUYV</i>	
<i>YUV422_8_UYVY</i>	<i>YUV422_8_UYVY</i>	<i>Color camera: YUV422_8_UYVY</i>	
<i>YUV422_8_UYVY</i>	<i>YUV422Packed</i>	<i>Color camera: YUV422_8_UYVY (same as previous for compatibility with third party software)</i>	1.06
Chunk Exposure Delay	chunkExposureDelay	Specifies the delay in microseconds (μ s) to apply after the FrameStart event, before starting the ExposureStart event.	1.04 Guru
counter1 Value At Reset	chunkCounter1ValueAtReset	Copies the value of the feature "counterValueAtReset" at the start of Frame Readout, to the Metadata attached to the image. Supported only in GenAPI compatibility mode.	1.04 Guru

Important Metadata Notes:

- For firmware revisions 1.04 OffsetX and OffsetY chunk data will return values without accounting for any binning applied. Later versions of firmware will return metadata values matching the OffsetX and OffsetY features.
- When using Metadata in conjunction with TurboDrive, the Nano driver (all models) requires that the image acquisition width (horizontal crop) must be a minimum of 160 pixels in 8-bit mode or 96 pixels in 10/12-bit mode. The driver requires this minimum width to correctly apply the TurboDrive compression algorithm. When acquisitions are cropped more than the minimum widths, TurboDrive is automatically disabled while Metadata remains active.

Extracting Metadata Stored in a Sapera Buffer

For Sapera LT developers, a new class “SapMetadata” is now included with Sapera version 8.10. For users of earlier versions of Sapera 8.xx, please contact Teledyne DALSA technical support.

Sapera also provides two methods to view metadata. The Sapera CamExpert tool provides a tab (when the Metadata feature is enabled) to view the metadata of the last frame capture, as shown by the following image.

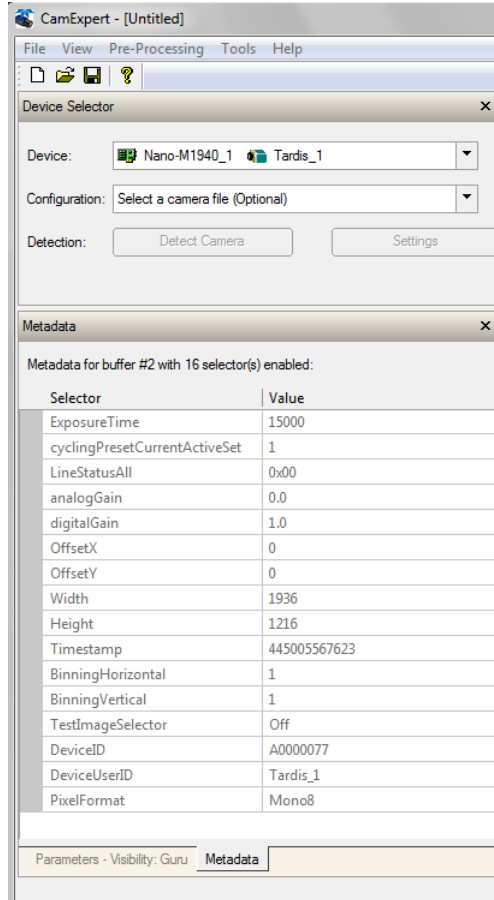

Alternatively, Sapera LT provides a demo program called GigEMetaDataDemo.exe which will grab a number of frames and display the metadata or save it to a file (.csv). In addition, source code and C++ project files are included for a console based executable.

The following figure shows the Sapera Explorer tool screen with the Metadata Example highlighted.



Important:

When an internal [Nano Test Image](#) is selected, the Metadata feature values for Exposure Time (*ExposureTime*) and Exposure Delay (*exposureDelay*) are not valid values and must be ignored.

When in free running (not triggered) mode, the Metadata value for feature Exposure Delay (*exposureDelay*) is not a valid value and must be ignored.

The value of LineStatusAll is updated on the start of exposure.

Currently the metadata value for “analogGain” is invalid for all On-Semi sensor models. For Sony sensor models, the metadata “analogGain” represents the raw gain value divided by 100.

Sapera Explorer

Select a category to view available applications. To run the selected application, click the active tile. show items for **all devices**

Here are the Sapera console code samples:

all	GenICam Find Camera Example	GenICam Camera Events Example
T2IR	GenICam Camera Features Example	Genie Auto White Balance Example
tools	Genie Camera LUT Example	GigE-Vision Metadata Example
demos	GenICam Camera Files Example	Grab Console Example
examples	Grab MFC Example	GenCP Grab CameraLink Example
help	File Load Console Example	File Load MFC Example
	Grab LUT Example	Color Split Example

GigE-Vision Metadata Example

 only

This example shows how to exploit the metadata related features of a Teledyne DALSA GigE-Vision camera.

 open project files for c++

Sapera Explorer for Sapera LT version 8.10.01.1607
Copyright © Teledyne DALSA Inc.

Acquisition and Transfer Control Category

The Genie Nano Acquisition and Transfer controls, as shown by CamExpert, has parameters used to configure the optional acquisition modes of the device.

Parameters in gray are read only, either always or due to another parameter being disabled. Parameters in black are user set in CamExpert or programmable via an imaging application.

Features listed in the description table but tagged as *Invisible* are usually for Teledyne DALSA or third party software usage—not typically needed by end user applications. Also important, Genie Nano cameras are available in a number of models implementing different sensors and image resolutions which may not support the full feature set defined in this category.

Category	Parameter	Value
Camera Information	Acquisition Status Selector	Acquisition Active
<input type="checkbox"/> Sensor Control	Acquisition Status	False
Auto-Brightness	Acquisition Mode	Not Enabled
I/O Controls	Acquisition Frame Count	Not Enabled
Counter And Timer Control	Acquisition Arm Cmd	Press...
<input type="checkbox"/> Advanced Processing	Acquisition Start Cmd	Not Enabled
Color Processing	Acquisition Stop Cmd	Not Enabled
Cycling Preset	Acquisition Abort Cmd	Not Enabled
Image Format Controls	Transfer Control	Basic
<input type="checkbox"/> Metadata Controls	Transfer Queue Current Block Count	0
Chunk Parser	Transfer Queue Memory Size	84.0
Acquisition and Transfer Control	Transferred Image Max Data Size	1.262
Action Control	Transferred Image Min Data Size	1.262
<input type="checkbox"/> Event Control	Transferred Image Average Data Size	1.262
<input type="checkbox"/> Event Info	Maximum Sustained Frame Rate	66.277
GigE Vision Transport Layer	<< Less	
File Access Control		
GigE Vision Host Controls		

Acquisition and Transfer Control Feature Descriptions

The following table describes these parameters along with their view attribute and minimum camera firmware version required. Additionally the Device Version column will indicate which parameter is a member of the DALSA Features Naming Convention (denoted by DFNC), versus the GenICam Standard Features Naming Convention (SFNC tag is not shown).

The Device Version number represents the camera software functional group, not a firmware revision number. As Genie Nano capabilities evolve the device version tag will increase, therefore identifying the supported function package. New features for a major device version release will be indicated by **green text** for easy identification.

Display Name	Feature & Values	Description	Device Version & View
Acquisition Status Selector	AcquisitionStatusSelector	Selects the internal acquisition signal to read using AcquisitionStatus.	1.00 Expert
<i>Acquisition Active</i>	<i>AcquisitionActive</i>	<i>Device is currently doing an acquisition of one or many frames.</i>	
<i>Acquisition Trigger Wait</i>	<i>AcquisitionTriggerWait</i>	<i>Device is currently waiting for a trigger to start the acquisition.</i> <i>(Ver. 1.05)</i>	
Acquisition Status	AcquisitionStatus	Reads the state of the internal acquisition signal selected using the Acquisition Status Selector feature. (i.e. False / True)	1.00 Expert
Acquisition Mode	AcquisitionMode	Set the acquisition mode of the device. It defines the number of frames to capture during an acquisition and the way the acquisition stops.	1.00 Beginner
<i>Single Frame</i>	<i>SingleFrame</i>	<i>One frame is captured for each AcquisitionStart Command. An AcquisitionStop occurs at the end of the Active Frame.</i>	
<i>Multi-Frame</i>	<i>MultiFrame</i>	<i>A sequence of frames is captured for each AcquisitionStart Command. The number of frames is specified by AcquisitionFrameCount feature. An AcquisitionStop occurs at the end of the Active Frame(s)</i>	
<i>Continuous</i>	<i>Continuous</i>	<i>Frames are captured continuously with AcquisitionStart until stopped with the AcquisitionStop command.</i>	
Acquisition Frame Count	AcquisitionFrameCount	Number of frames to be acquired in MultiFrame acquisition mode.	1.00 Beginner
Acquisition Arm Cmd	AcquisitionArm	Arms the device before an AcquisitionStart command. This optional command validates all the current features for consistency and prepares the device for a fast start of the acquisition. If not used explicitly, this command is automatically executed at the first AcquisitionStart but will not be repeated for subsequent ones unless a data transfer related feature is changed in the device.	1.00 Guru
Acquisition Start Cmd	AcquisitionStart	Start image capture using the currently selected acquisition mode. The number of frames captured is specified by AcquisitionMode feature.	1.00 Beginner
Acquisition Stop Cmd	AcquisitionStop	Stops the Acquisition of the device at the end of the current frame unless the triggerFrameCount feature is greater than 1. (WO)	1.00 Beginner
Acquisition Abort Cmd	AcquisitionAbort	Aborts the acquisition immediately. This will end the capture without completing the current Frame or aborts waiting on a trigger. If no acquisition is in progress, the command is ignored.	1.00 Beginner
Transfer Control	TransferControlMode	Sets the method used to control the transfer.	1.00

<i>Basic</i>	<i>Basic</i>	<i>Basic mode ensures maximum compatibility but does not allow for control of the transfer flow.</i>	Expert
Transfer Queue Current Block Count	transferQueueCurrentBlockCount	Returns the current number of blocks in the transfer queue.	1.00 DFNC Expert
Transfer Queue Memory Size	transferQueueMemorySize	Indicates the amount of device memory (in Mbytes) available for internal image frame accumulation in the transfer queue. Increasing or decreasing memory reserved by devicePacketResendBufferSize will affect total memory available here.	1.00 DFNC Expert
Transferred Image Max Data Size	transferMaxBlockSize	Biggest image (GVE blocks) data size sent on the GigE cable. The value is displayed in Megabytes. Use this value to calculate the frame rate transferred on the GigE cable. GigE Link speed (~115 MB) divided by Biggest Image (value) = Max fps transferred. Note: This statistic is reset when acquisitions are stopped.	1.01 DFNC Beginner
Transferred Image Min Data Size	transferMinBlockSize	Smallest image (GVE blocks) data size sent on the GigE cable. The value is displayed in Megabytes. Note: This statistic is reset when acquisitions are stopped.	1.01 DFNC Beginner
Transferred Image Average Data Size	transferAverageBlockSize	Average size of the last 16 images (GVE blocks) of data sent on the GigE cable. The value is displayed in Megabytes. Use this value to calculate the sustained frame rate transferred on the GigE cable. GigE Link speed (~115 MB) divided by Average size (value) = Max fps transferred. When TurboDrive is enabled, this feature allows monitoring the average throughput.	1.01 DFNC Beginner
Maximum Sustained Frame Rate	maxSustainedFrameRate	Maximum sustained frame rate that can be achieved by the camera in the current configuration (Resolution, Pixel Format and the camera's internal bandwidth limitations). When TurboDrive is enabled, this value also takes the feature transferAverageBlockSize into account.	1.03 DFNC Beginner
Device Registers Streaming Start	DeviceRegistersStreamingStart	Announces the start of registers streaming without immediate checking for consistency.	1.00 Invisible
Device Registers Streaming End	DeviceRegistersStreamingEnd	Announces end of registers streaming and performs validation for registers consistency before activating them.	1.00 Invisible
Device Feature Streaming Start	DeviceFeaturePersistenceStart	Announces the start of feature streaming without immediate checking for consistency.	1.00 Invisible
Device Feature Streaming End	DeviceFeaturePersistenceEnd	Announces end of feature streaming and performs validation for feature consistency before activating them.	1.00 Invisible
Register Check	DeviceRegistersCheck	Performs an explicit register set validation for consistency.	1.00 Invisible
Registers Valid	DeviceRegistersValid	States if the current register set is valid and consistent.	1.00 Invisible

Acquisition Buffering

All acquisitions are internally buffered and transferred as fast as possible to the host system. This internal buffer allows uninterrupted acquisitions no matter of any transfer delays that might occur (such as acquisition frame rates faster than the Gigabit Ethernet link or the [IEEE Pause frame](#)). Only when the internal buffer is consumed would an Image Lost Event be generated.

Using Transfer Queue Current Block Count with CamExpert

This feature returns the number of frames buffered within the Genie Nano pending transfer to the host system. Image frames are buffered in cases where the host system is temporarily busy or cases of high network traffic with other devices through the same Ethernet switch. By buffering image frames, the Genie Nano will not need to drop frames when there are temporary delays to the transfer.

When using CamExpert, right click on this field and then click on Refresh from the pop-up menu. The current frame count in the transfer buffer is displayed in the *Value* field. During live grab, if the number of frames in the transfer buffer is increasing, then there is a problem with the network or host bandwidth being exceeded. The ImageLost event occurs when all buffer space is consumed.

“Acquisition Abort” Execution Exception with Model C4900

For the model C4900 (Aptina sensor) the *AcquisitionAbort* feature does not execute immediately, as is the case for all other Nano models.

When aborting an acquisition with the C4900, the application needs to follow this sequence:

- Set the feature AcquisitionStatusSelector=AcquisitionActive
- Send the command AcquisitionAbort
- Poll the status AcquisitionStatus until it is FALSE

Features that cannot be changed during a Transfer

The following features cannot be changed during an acquisition or when a transfer is connected.

Feature Group	Features Locked During a Spera Transfer
CAMERA INFORMATION	UserSetLoad
SENSOR CONTROL	NA
I/O CONTROL	NA
COUNTER AND TIMER CONTROL	NA
IMAGE FORMAT CONTROL	PixelFormat OffsetX (except within the Cycling Mode) OffsetY (except within the Cycling Mode) Binning (except within the Cycling Mode) Width Height Multi-ROI functions
Metadata Controls	ChunkModeActive
ACQUISITION AND TRANSFER CONTROL	DeviceRegistersStreamingStart DeviceRegistersStreamingEnd
EVENT CONTROL	NA
GIGE VISION TRANSPORT LAYER CONTROL	GevSCPSPacketSize
GIGE VISION HOST CONTROL	InterPacketTimeout InterPacketTimeoutRaw ImageTimeout
FILE ACCESS CONTROL	NA

Action Control Category

The Genie Nano Action Control group, as shown by CamExpert, has features related to the control of the Action Command mechanism for the device.

Parameters in gray are read only, either always or due to another parameter being disabled. Parameters in black are user set in CamExpert or programmable via an imaging application.

Features listed in the description table but tagged as *Invisible* are usually for Teledyne DALSA or third party software usage—not typically needed by end user applications. Also important, Genie Nano cameras are available in a number of models implementing different sensors and image resolutions which may not support the full feature set defined in this category.

Category	Parameter	Value
Camera Information	Action Device Key	0x0000000000000000
Sensor Control	Action Selector	1
I/O Controls	Action Group Key	0x0000000000000000
Counter And Timer Control	Action Group Mask	0x0000000000000000
Advanced Processing	<< Less	
Cycling Preset		
Image Format Controls		
Metadata Controls		
Acquisition and Transfer Cont...		
Action Control		
<input checked="" type="checkbox"/> Event Control		
GigE Vision Transport Layer		
File Access Control		
GigE Vision Host Controls		

Action Control Feature Descriptions

The following table describes these parameters along with their view attribute and minimum camera device version required. Additionally the Device Version column will indicate which parameter is a member of the DALSA Features Naming Convention (denoted by DFNC), versus the GenICam Standard Features Naming Convention (SFNC tag is not shown).

The Device Version number represents the camera software functional group, not a firmware revision number. As Genie Nano capabilities evolve the device version tag will increase, therefore identifying the supported function package. New features for a major device version release will be indicated by **green text** for easy identification.

Display Name	Feature & Values	Description	Device Version & View
Action Device Key	ActionDeviceKey	<i>Nano default=1</i> <i>Writing 0 will disable action command.</i> Provides the device key that allows the device to check the validity of action commands. (WO)	1.03 Guru
Action Selector	ActionSelector	Selects the action command to configure. Certain Nano features support 2 Action commands.	1.03 Beginner
Action Group Key	ActionGroupKey	<i>Nano default=0 for all action command.</i> Provides the key that the device uses to validate that the action command message is part of the requested group.	1.03 Guru
Action Group Mask	ActionGroupMask	<i>Nano default=1 for action 1, or 2 for action 2.</i> Provides the mask used to filter particular action command messages for the selected action.	1.03 Guru

GigE Vision Action Command Reference

An Action Command is a single Broadcast packet sent from the Host Software application to all cameras connected on the same network. How cameras act on an Action Command depends on its designed feature support. Cameras receiving the Action Command broadcast may have one or multiple functions acting on that received command.

Please refer to the GigE Vision® Specification — version 2.0 RC6, for configuration and usage details. Contact [Teledyne DALSA Support](#) and request example code for Action Command usage.

Nano Features supporting Action Command

Feature Category	Feature	Enum
I/O Control	Trigger Selector	Single Frame Trigger (Start) MultiFrame Trigger (Start)
	Trigger Source	Action 1
	Output Line Source	Pulse On: Action 1 Pulse On: Action 2
Counter and Timer Control	Counter Start Source	Action 1 Action 2
	Timer Start Source	Action 1 Action 2

Event Control Category

The Genie Nano Event control, as shown by CamExpert, has parameters used to configure Camera Event related features. Parameters in gray are read only, either always or due to another parameter being disabled. Parameters in black are user set in CamExpert or programmable via an imaging application.

Features listed in the description table but tagged as *Invisible* are usually for Teledyne DALSA or third party software usage—not typically needed by end user applications. Also important, Genie Nano cameras are available in a number of models implementing different sensors and image resolutions which may not support the full feature set defined in this category.

Category	Parameter	Value
Camera Information	Timestamp Latch Cmd	Press...
Event Control	Timestamp Value	0
I/O Controls	Timestamp Source	Internal Clock
Counter And Timer Control	Timestamp Tick Frequency (in Hz)	1000000
Advanced Processing	Timestamp Latch Source	Frame Start
Cycling Preset	Timestamp Reset Cmd	Press...
Image Format Controls	Event Selector	Start of Frame
Metadata Controls	Event Notification	Off
Acquisition and Transfer Control	Event Statistic Selector	Invalid Frame Trigger
Action Control	Event Statistic Count	0
Event Control	Event Statistic Count Reset	Press...
Event Info	PTP Mode	Off
GigE Vision Transport Layer	PTP Status	Disabled
File Access Control	PTP Servo Status	Not Applicable
GigE Vision Host Controls	PTP Master Clock Identity	
	PTP Master Offset (in ns) (in ns)	Not Enabled
	PTP Port Last Event	None
	PTP Transport Protocol	UDP_IPV4
	PTP Servo Step Threshold (in us)	Threshold_10
	Timestamp Modulo Event	0
	Timestamp Modulo Event Frequency	Not Enabled
	Timestamp Modulo Start Time	0
	Timestamp Modulo Actual Start Time	0
	<< Less	

Event Control Feature Descriptions

The following table describes these parameters along with their view attribute and minimum camera firmware version required. Additionally the Device Version column will indicate which parameter is a member of the DALSA Features Naming Convention (denoted by DFNC), versus the GenICam Standard Features Naming Convention (SFNC tag is not shown).

The Device Version number represents the camera software functional group, not a firmware revision number. As Genie Nano capabilities evolve the device version tag will increase, therefore identifying the supported function package. New features for a major device version release will be indicated by **green text** for easy identification.

Display Name	Feature & Values	Description	Device Version & View
Timestamp Latch Cmd	timestampControlLatch	Latch the current timestamp internal counter value in the timestampValue feature.	1.00 Expert DFNC
Timestamp Value	timestampValue	Returns the 64-bit value of the timestamp, which is the internal Clock timer or the PTP clock timer, depending on the Timestamp Source selection.	1.00 Expert DFNC
TimeStamp Source	timestampSource	Specifies the source used as the incrementing signal for the Timestamp register.	1.00 Expert DFNC
<i>Internal Clock</i>	<i>InternalClock</i>	<i>The timestamp source is generated by the camera internal clock. Refer to the timestampTickFrequency feature for the time base.</i>	
<i>IEEE1588</i>	<i>IEEE1588</i>	<i>The timestamp source is controlled by the network IEEE1588 protocol. This source is automatically selected when PTP mode is enabled.</i>	
Timestamp Tick Frequency	timestampTickFrequency	Indicates the number of timestamp ticks (or increments) during 1 second (frequency in Hz). This feature changes depending on the TimeStamp Source.	1.00 Expert DFNC
Timestamp Latch Source	timestampLatchSource	Specifies the internal event or signal that will latch the timestamp counter into the timestamp buffer.	1.00 Expert DFNC
<i>Frame Start</i>	<i>FrameStart</i>	<i>The timestamp is latched on frame start.</i>	
Timestamp Reset Cmd	timestampControlReset	Resets the timestamp counter to 0. This Feature resets both the internal Clock timer and the PTP clock timer. Note that the PTP Mode must be disabled first to reset the PTP clock timer.	1.00 Expert DFNC
Event Selector	EventSelector	Select the Event to enable/disable with the EventNotification feature.	1.00 Expert
<i>Start of Frame</i>	<i>FrameStart</i>	<i>Event sent on control channel on an Active Frame. This occurs with the start of the exposure delay.</i>	
<i>Start of Exposure</i>	<i>ExposureStart</i>	<i>Event sent on control channel on start of exposure.</i>	
<i>End of Exposure</i>	<i>ExposureEnd</i>	<i>Event sent on control channel on end of exposure. (N/A for C4900 – 1.06)</i>	
<i>Start of Readout</i>	<i>ReadoutStart</i>	<i>Event sent on control channel on start of sensor readout.</i>	
<i>End of Readout</i>	<i>ReadoutEnd</i>	<i>Event sent on control channel on end of sensor readout.</i>	
<i>Acquisition Start Next Valid</i>	<i>AcquisitionStartNextValid</i>	<i>Event sent on control channel when the AcquisitionStart command can be used again.</i>	
<i>Valid Frame Trigger</i>	<i>ValidFrameTrigger</i>	<i>Event sent on control channel when a valid frame trigger is generated.</i>	

<i>Invalid Frame Trigger</i>	<i>InvalidFrameTrigger</i>	Event sent on control channel when a frame trigger occurs in an invalid Trigger region. Therefore the trigger is rejected and no frame acquisition occurs.	
<i>Image Lost</i>	<i>ImageLost</i>	Event sent on control channel when an image is lost due to insufficient memory.	
<i>Counter 1 End</i>	<i>Counter1End</i>	Event sent when counter 1 has reached the counterDuration count. (ver. 1.06)	
<i>Events Overflow</i>	<i>eventsOverflow</i>	Event sent on control channel when all previous active events have been disabled because the camera cannot send them fast enough, generating in internal message overflow. Required events must be re-enabled manually.	
Event Notification	EventNotification	Enable Events for the event type selected by the EventSelector feature.	1.00 Expert
<i>Off</i>	<i>Off</i>	The selected event is disabled.	
<i>On</i>	<i>On</i>	The selected event will generate a software event.	
<i>GigEVisionEvent</i>	<i>GigEVisionEvent</i>	The selected event will generate a software event. This entry is deprecated. Using "On" is recommended.	
Event Statistic Selector	eventStatisticSelector	Selects which Event statistic to display.	1.00 Expert DFNC
<i>Invalid Frame Trigger</i>	<i>InvalidFrameTrigger</i>	Counts the frame trigger occurring in an invalid Trigger region.	
<i>Image Lost</i>	<i>ImageLost</i>	Image is acquired but lost before it's been transferred.	
<i>Packet Resend</i>	<i>PacketResend</i>	Counts the number of individual packets that are resent.	
<i>Packet Resend Request Dropped</i>	<i>PacketResendRequestDropped</i>	Counts the number of packet resend requests dropped. The camera queues the packet resend requests until they are processed. There is a limit to the number of requests that can be queued by the camera. When a new request is received and the queue is full, the request is dropped but this statistic is still incremented.	
<i>Ethernet Pause Frame Received</i>	<i>EthernetPauseFrameReceived</i>	Counts the number of Ethernet Pause Frame received. Feature limited to 65536 events. See also PAUSE Frame Support for information on Ethernet Packet size.	
Event Statistic Count	eventStatisticCount	Display the count of the selected Event.	1.00 Expert DFNC
Event Statistic Count Reset	eventStatisticCountReset	Reset the count of the selected Event.	1.00 Expert DFNC
PTP Mode	ptpMode	Specifies the PTP (IEEE-1588: Precision Time Protocol) operating mode as implemented by the Genie Nano.	1.03 Expert DFNC
<i>Off</i>	<i>Off</i>	PTP is disabled on the device.	
<i>Automatic</i>	<i>Automatic</i>	PTP is enabled on the device. The camera can become a Master or Slave device. The Master device is automatically determined as per IEEE-1588.	
<i>Slave</i>	<i>Slave</i>	Device will operate in PTP slave-only mode.	
PTP Status	ptpStatus	Specifies dynamically the current PTP state of the device. (ref: IEEE Std 1588-2008)	1.03 Expert DFNC
<i>Initializing</i>	<i>Initializing</i>	The port initializes its data sets, hardware, and communication facilities. No port of the clock shall place any PTP messages on its communication path. If one port of a boundary clock is in the INITIALIZING state, then all ports shall be in the INITIALIZING state.	

<i>Faulty</i>	<i>Faulty</i>	<i>The fault state of the protocol. A port in this state shall not place any PTP messages except for management messages that are a required response to another management message on its communication path. In a boundary clock, no activity on a faulty port shall affect the other ports of the device. If fault activity on a port in this state cannot be confined to the faulty port, then all ports shall be in the FAULTY state.</i>	
<i>Disabled</i>	<i>Disabled</i>	<i>The port shall not place any messages on its communication path. In a boundary clock, no activity at the port shall be allowed to affect the activity at any other port of the boundary clock. A port in this state shall discard all PTP received messages except for management messages.</i>	
<i>Listening</i>	<i>Listening</i>	<i>The port is waiting for the announceReceiptTimeout to expire or to receive an Announce message from a master. The purpose of this state is to allow orderly addition of clocks to a domain. A port in this state shall not place any PTP messages on its communication path except for Pdelay_Req, Pdelay_Resp, Pdelay_Resp_Follow_Up, or signaling messages, or management messages that are a required response to another management message.</i>	
<i>PreMaster</i>	<i>PreMaster</i>	<i>The port shall behave in all respects as though it were in the MASTER state except that it shall not place any messages on its communication path except for Pdelay_Req, Pdelay_Resp, Pdelay_Resp_Follow_Up, signaling, or management messages.</i>	
<i>Master</i>	<i>Master</i>	<i>The port is behaving as a master port.</i>	
<i>Passive</i>	<i>Passive</i>	<i>The port shall not place any messages on its communication path except for Pdelay_Req, Pdelay_Resp, Pdelay_Resp_Follow_Up, or signaling messages, or management messages that are a required response to another management message.</i>	
<i>Uncalibrated</i>	<i>Uncalibrated</i>	<i>One or more master ports have been detected in the domain. The appropriate master port has been selected, and the local port is preparing to synchronize to the selected master port. This is a transient state to allow initialization of synchronization servos, updating of data sets when a new master port has been selected, and other implementation-specific activity.</i>	
<i>Slave</i>	<i>Slave</i>	<i>The port is synchronizing to the selected master port.</i>	
<i>GrandMaster</i>	<i>GrandMaster</i>	<i>The port is in the GrandMaster state (i.e. has the best clock). The camera can become GrandMaster only if the PTP Mode=Automatic and there's another device on the network that was Master.</i>	
<i>Error</i>	<i>Error</i>	<i>One or more ports have an error state.</i>	
PTP Servo Status	ptpServoStatus	Specifies the IEEE1588 servo status.	1.03 Expert DFNC
<i>Unlocked</i>	<i>Unlocked</i>	<i>The servo is not yet ready to track the master clock.</i>	
<i>Synchronizing</i>	<i>Synchronizing</i>	<i>The servo is unlocked and synchronizing to the master clock.</i>	
<i>Locked</i>	<i>Locked</i>	<i>The servo is adjusting (synchronizing) to the master clock.</i>	
<i>Not Applicable</i>	<i>NotApplicable</i>	<i>The servo state is currently not applicable.</i>	
PTP Master Clock Identity	ptpMasterClockId	Port identity of the current best master. The clock ID is an Extended Unique Identifier (EUI)-64 64-bit ID, converted from the 48-bit MAC address, by inserting 0xffff at the middle of the MAC address.	1.03 Guru DFNC

PTP Master Offset	ptpMasterOffsetNs	Dynamically returns the 64-bit value of the PTP offset with the master. This value is the input for clock corrections for the slave device clock servo algorithms.	1.03 Guru DFNC
PTP Port Last Event	ptpPortLastEvent	Logs the last PTP changed state event defining the last current status.	1.03 Expert DFNC
<i>None</i>	<i>None</i>	<i>None</i>	
<i>Power up</i>	<i>Powerup</i>	<i>Power up</i>	
<i>Initialize</i>	<i>Initialize</i>	<i>Initialize</i>	
<i>Designated Enabled</i>	<i>DesignatedEnabled</i>	<i>Designated Enabled</i>	
<i>Designated Disabled</i>	<i>DesignatedDisabled</i>	<i>Designated Disabled</i>	
<i>Fault Cleared</i>	<i>FaultCleared</i>	<i>Fault Cleared</i>	
<i>Fault Detected</i>	<i>FaultDetected</i>	<i>Fault Detected</i>	
<i>State Decision Event</i>	<i>StateDecisionEvent</i>	<i>State Decision Event</i>	
<i>Qualification Timeout Expires</i>	<i>QualificationTimeoutExpires</i>	<i>Qualification Timeout Expires</i>	
<i>Announce Receipt Timeout Expires</i>	<i>AnnounceReceiptTimeoutExpires</i>	<i>Announce Receipt Timeout Expires</i>	
<i>Synchronization Fault</i>	<i>SynchronizationFault</i>	<i>Synchronization Fault</i>	
<i>Master Clock Selected</i>	<i>MasterClockSelected</i>	<i>Master Clock Selected</i>	
<i>Recommended State Master</i>	<i>RS_Master</i>	<i>Recommended State Master</i>	
<i>Recommended State Grand Master</i>	<i>RS_GrandMaster</i>	<i>Recommended State Grand Master</i>	
<i>Recommended State Slave</i>	<i>RS_Slave</i>	<i>Recommended State Slave</i>	
<i>Recommended State Passive</i>	<i>RS_Passive</i>	<i>Recommended State Passive</i>	
PTP Transport Protocol	ptpTransportProtocol	Describes the PTP Transport Protocol used.	1.03 Expert DFNC
PTP Servo Step Threshold (in us)	ptpServoStepThreshold	Specifies the servo step threshold (in us). When the clock offset with the master exceeds the threshold, the servo unlocks and offset adjustment is started.	1.07 Expert DFNC
<i>Threshold_10</i>	<i>Threshold_10</i>		
<i>Threshold_20</i>	<i>Threshold_20</i>		
<i>Threshold_100</i>	<i>Threshold_100</i>		
<i>Threshold_500</i>	<i>Threshold_500</i>		
<i>Threshold_1000</i>	<i>Threshold_1000</i>		
<i>Threshold_2000</i>	<i>Threshold_2000</i>		
Timestamp Modulo Event	timestampModulo	Specifies the additional interval between the current timestamp tick and the event generated. This interval has an 80ns accuracy. Note that the value zero disables the event generator.	1.03 Expert DFNC
Timestamp Modulo Event Frequency	timestampModuloFrequency	Returns the frequency of the timestamp Modulo Event (in Hz).	1.03 Expert DFNC
Timestamp Modulo Start Time	timestampModuloStartTime	Specifies the timestamp value that must be exceeded by the incrementing timestamp counter before the modulo event starts. This Feature is also used for a "Future" Frame Acquisition.	1.03 Expert DFNC

Timestamp Modulo Actual Start Time	timestampModuloActualStartTime	Displays the actual modulo event start time as used by the device. When the user specified "timestampModuloStartTime" is in the future, timestampModuloActualStartTime=timestampModuloStartTime. When the user specified "timestampModuloStartTime" has already past, the camera automatically recalculates a future value for "timestampModuloStartTime" using the user set "timestampModulo" feature value. This new start time is reported by "timestampModuloActualStartTime".	1.03 Expert DFNC
Frame Start Data	EventFrameStartData	Data of the frame start event	1.00 Guru
Frame Start Event ID	EventFrameStart	Represents the event ID to identify the EventFrameStart software Event. (RO)	1.00 Guru
Frame Start Event Timestamp	EventFrameStartTimestamp	Timestamp of the EventFrameStart event. (RO)	1.00 Guru
Exposure Start Event ID	EventExposureStart	Represents the event ID to identify the EventExposureStart software Event. (RO)	1.00 Guru
Exposure Start Data	EventExposureStartData	Data of the exposure start event	1.00 Guru
Exposure Start Event Timestamp	EventExposureStartTimestamp	Timestamp of the EventExposureStart event. (RO)	1.00 Guru
Exposure End Event ID	EventExposureEnd	Represents the event ID to identify the EventExposureEnd software Event.	1.00 Guru
Exposure End Data	EventExposureEndData	Data of the exposure end event	1.00 Guru
Exposure End Event Timestamp	EventExposureEndTimestamp	Timestamp of the EventExposureEnd event. (RO)	1.00 Guru
AcquisitionStartNextValid Event ID	EventAcquisitionStartNextValid	Generate an event on acquisition start next valid.	1.00 Guru
Acquisition Start Next Valid End Data	EventAcquisitionStartNextValidData	Data of the acquisition start next valid event.	1.00 Guru
AcquisitionStartNextValid Event Timestamp	EventAcquisitionStartNextValidTimestamp	Timestamp of the acquisition start next valid event. (RO)	1.00 Guru
Valid Frame Trigger Event ID	EventValidFrameTrigger	Generate an event on valid frame trigger.	1.00 Guru
Valid Frame Trigger Data	EventValidFrameTriggerData	Data of the valid frame trigger event.	1.00 Guru
Valid Frame Trigger Event Timestamp	EventValidFrameTriggerTimestamp	Timestamp of the Valid frame trigger event. (RO)	1.00 Guru
InvalidFrameTrigger Event ID	EventInvalidFrameTrigger	Generate an event on invalid frame trigger.	1.00 Guru
Invalid Frame Trigger Data	EventInvalidFrameTriggerData	Data of the invalid frame trigger event.	1.00 Guru
InvalidFrameTrigger Event Timestamp	EventInvalidFrameTriggerTimestamp	Timestamp of the invalid frame trigger event. (RO)	1.00 Guru
ImageLost Event ID	EventImageLost	Generate an event on image lost.	1.00 Guru
Image Lost Data	EventImageLostData	Data of the image lost event.	1.00 Guru
ImageLost Event Timestamp	EventImageLostTimestamp	Timestamp of the image lost event. (RO)	1.00 Guru
Counter 1 End Data	EventCounter1EndData	Data of the Counter1 End event.	1.06 Guru
Counter 1 End ID	EventCounter1End	Generate an event on Counter 1 End.	1.06 Guru
Counter 1 End Event Timestamp	EventCounter1EndTimestamp	Timestamp of the Counter 1 End event.	1.06 Guru
Events Overflow Event ID	EventeventsOverflow	Represents the event ID to identify the EventeventsOverflow software Event. (RO)	1.00 Guru
Event Overflow Data	EventeventsOverflowData	Data of the event overflow event	1.00 Guru
Events Overflow Event Timestamp	EventeventsOverflowTimestamp	Timestamp of the EventeventsOverflow event.	1.00 Guru

I Timestamp Latch	GevtimestampControlLatch	Latch the current timestamp internal counter value in the timestampValue feature.	1.00 Invisible
I Timestamp Value	GevtimestampValue	Returns the 64-bit value of the timestamp counter.	1.00 Invisible
I Timestamp Tick Frequency	GevtimestampTickFrequency	Indicates the number of timestamp ticks (or increments) during 1 second (frequency in Hz).	1.00 Invisible
I Timestamp Reset	GevtimestampControlReset	Resets the timestamp counter to 0.	1.00 Invisible

Basic Exposure Events Overview

The following timing graphic shows the primary events related to a simple acquisition.

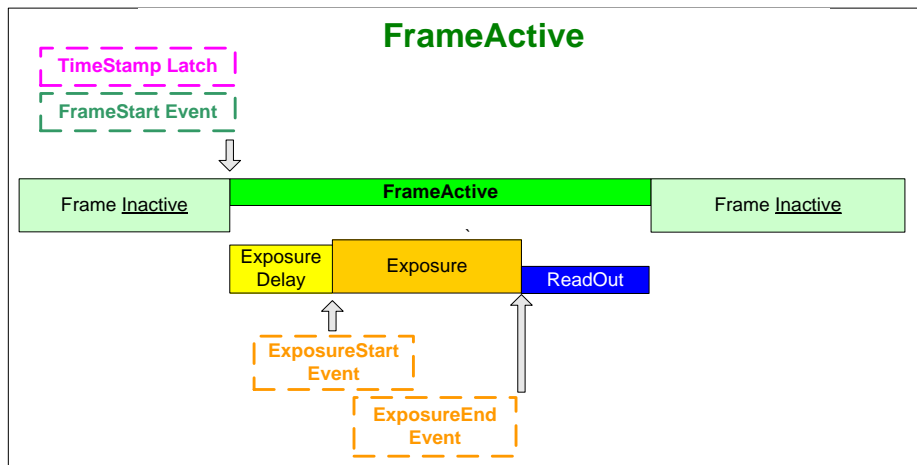

Events Associated with Triggered Synchronous Exposures

The following timing graphic shows the primary events and acquisition timing associated with a synchronous exposure of two individually triggered frames.

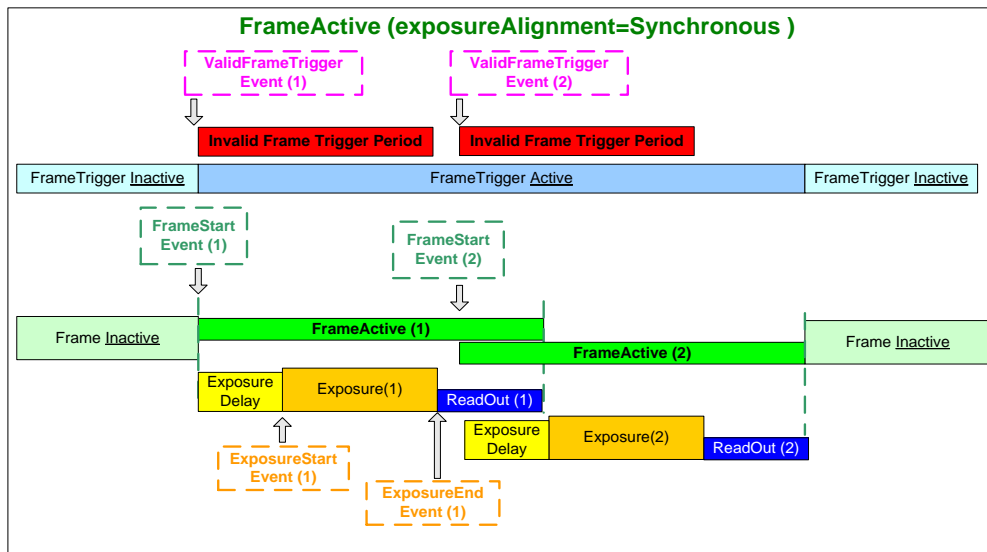

Events Associated with Triggered Multiple Frame Synchronous Exposures

The following timing graphic shows the primary events and acquisition timing associated with a synchronous exposure of two frames from a single trigger event.

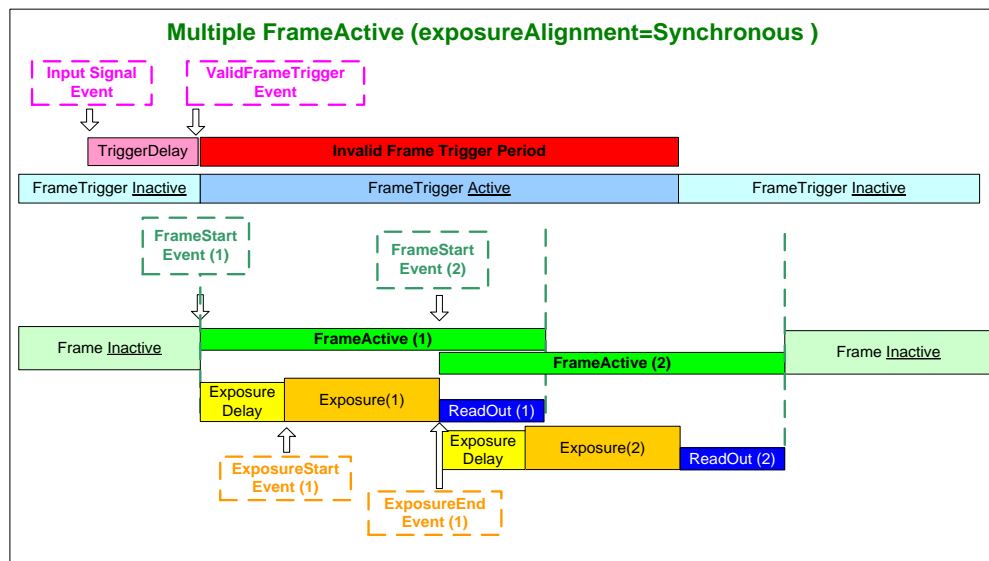

Overview of Precision Time Protocol Mode (IEEE 1588)

PTP Mode = Precision Time Protocol

- The PTP protocol synchronizes the Timestamp clocks of multiple devices connected via a switch on the same network, where the switch supports PTP.
- For optimal clock synchronization the imaging network should use one Ethernet switch. Daisy-chaining multiple small switches will degrade camera clock syncs.
- Additionally the Ethernet switch connecting cameras to the imaging network should implement “PTP Boundary Clock” hardware.
- To use a multi-port NIC adapter or computer with multiple NIC ports instead of a switch, that multiport NIC must be capable to be configured as the common Master PTP source for all its networks. Such a configuration requires using the multi-port NIC’s configuration software.
- Genie Nano cameras can automatically organize themselves into a master-slave hierarchy, or the user application configures a camera master with n-number of slaves. The auto-configuration process typically happens within 2 seconds.
- The automatic organizing procedure is composed of steps (as defined by IEEE 1588) to identify the best clock source to act as master. When only Nano cameras are used, since they are equal, the last selection step is to identify the Nano with lowest value MAC address to be the clock master.
- The feature *TimeStamp Source* is automatically changed to *IEEE1588* when *PTP Mode* is enabled. This timestamp tick (in ns) cannot be reset by the user.
- The Genie Nano cameras implement additional features designed to synchronize multiple camera acquisitions via IEEE 1588 (PTP Mode) – not via external camera trigger signals.

PTP Master Clock Identity

The clock ID of the current best master is an Extended Unique Identifier (EUI)-64 “64-bit ID”, converted from the 48-bit MAC address, by inserting 0xffff at the middle of the MAC address.

- The standard MAC address in human-friendly form is six groups of two hexadecimal digits as this example shows (excluding spaces): “0a 1b 2c 3d 4e 5f”
- The Extended Unique Identifier format is (excluding spaces): “0a 1b 2c fffe 3d 4e 5f”

An Example with two Nano Cameras

The following basic steps configure two Nano cameras connected to one computer via an Ethernet switch, configured with two instances of CamExpert, to grab a frame every second, controlled by a modulo event via PTP.

For each camera set features as follows:

I/O Controls — select Trigger Mode=ON, Tigger Source=Timestamp Modulo Event

Event Controls — select PTP Mode=Automatic

- Note how one Nano automatically becomes Master while the other becomes Slave

Event Controls — to have a modulo event every second, set Timestamp Modulo Event=1000000000

Click Grab on each instance of CamExpert. With the two cameras aimed at the same moving object, you see that each camera grabs a frame at the same time.

IEEE 1588 Reference Resources

For additional information: <http://standards.ieee.org>

PTP Standard Reference: IEEE Std 1588-2008 — IEEE Standard for a Precision Clock Synchronization Protocol for Networked Measurement and Control Systems

Examples using Timestamp Modulo Event for Acquisitions

The Timestamp Modulo event is used to synchronize multiple camera acquisitions and automate repetitive acquisitions based on either the camera's internal Timestamp counter or a system wide PTP counter. The Nano internal Timestamp clock has a 1 μ s tic, while the PTP clock has 8 nanosecond tics (PTP: IEEE1588–Precise Time Protocol).

Both Timestamp counters increment continuously but can be reset to zero with 'timestampControlReset' if 'ptpMode=Off', else only the internal camera Timestamp counter resets.

Case Examples Overview

The following case examples use a simplified Timestamp timeline, which for clarity is shown with time tics from 00 to 60 without units. A timeline scale based on real time is not required to describe the usage concepts. These examples also apply equally to using an internal Timestamp clock or a system PTP clock.

Case 1: Simple Repeating Acquisitions as Upcoming Events

Conditions:

- initial timestampControlReset resets Timestamp counter
- timestampModuloStartTime at 20
- timestampModulo = 10
- timestampModuloActualStartTime = First Event generated (F1)

After the Timestamp Reset, the first acquisition is made when the Modulo reaches the +10 tick Timestamp count, following the programmed start time. Acquisitions repeat at every +10 Timestamp tick until stopped.

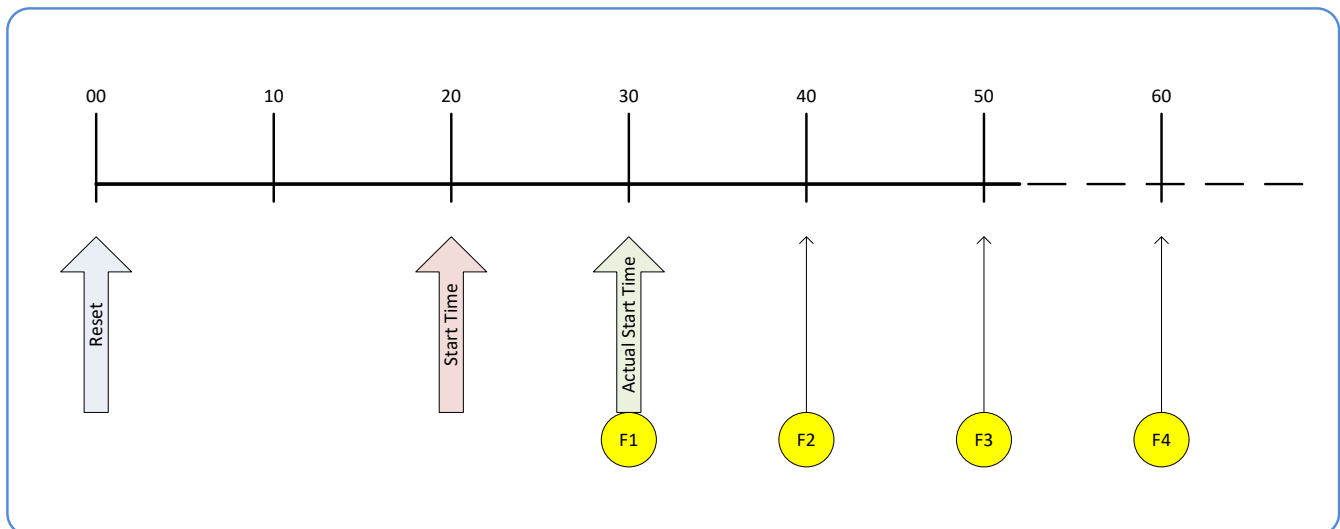

Case 2: Potential Uncertainty to the Start Time

Conditions:

- initial timestampControlReset resets Timestamp counter
- timestampModuloStartTime at < 20
- timestampModulo = 10
- timestampModuloActualStartTime = first event (F1)

Case 2 differs only from case 1 by showing that there is a period of uncertainty if the start time is too close to the first modulo count that follows. The first frame acquisition may occur at the first modulo count time or at the following. The actual value for the uncertainty period may vary with different camera and network conditions.

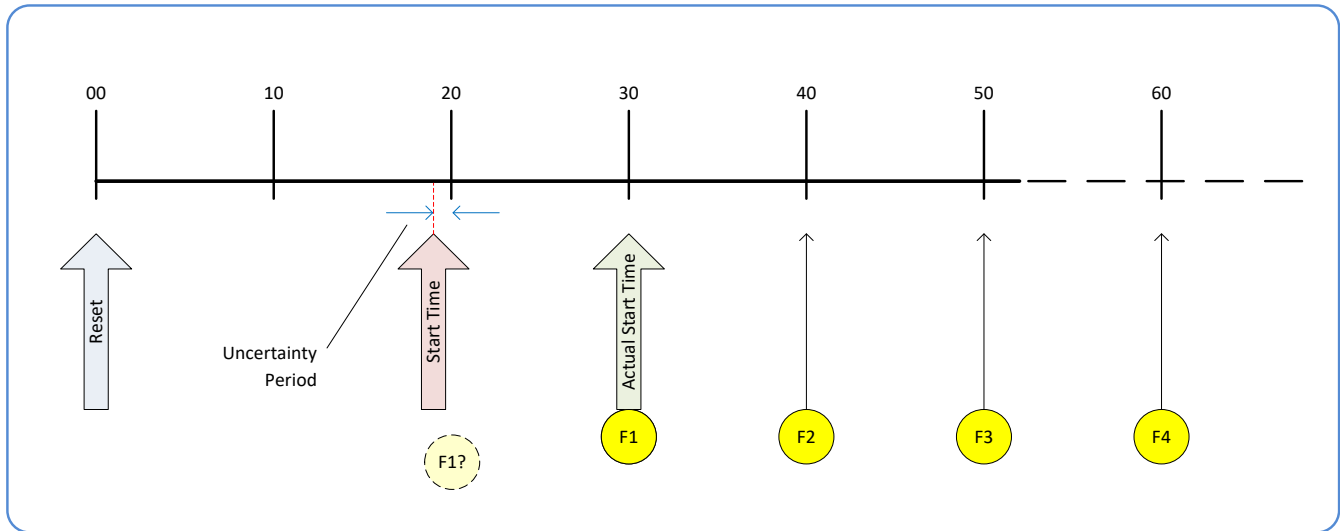

Case 3: Timer Reset before the Actual Start Time

Conditions:

- initial timestampControlReset resets Timestamp counter
- timestampModuloStartTime at 20
- timestampModulo = 10
- second timestampControlReset at count 25
- timestampModuloActualStartTime = first event (F1)

After the initial Timestamp Reset which starts the Timestamp counter, the Modulo start time is at 20. The Modulo 10 actual start time for the first acquisition is at Timestamp 30 (as described in Case 1).

Now if a new Timestamp reset happens between the Start Time and acquisition Actual Start Time, the Timestamp counter will restart from time 00, but the Start Time value has already been stored, thus the modulo Actual Start Time remains at 30. In this condition the Actual Start Time did not reset as might be expected.

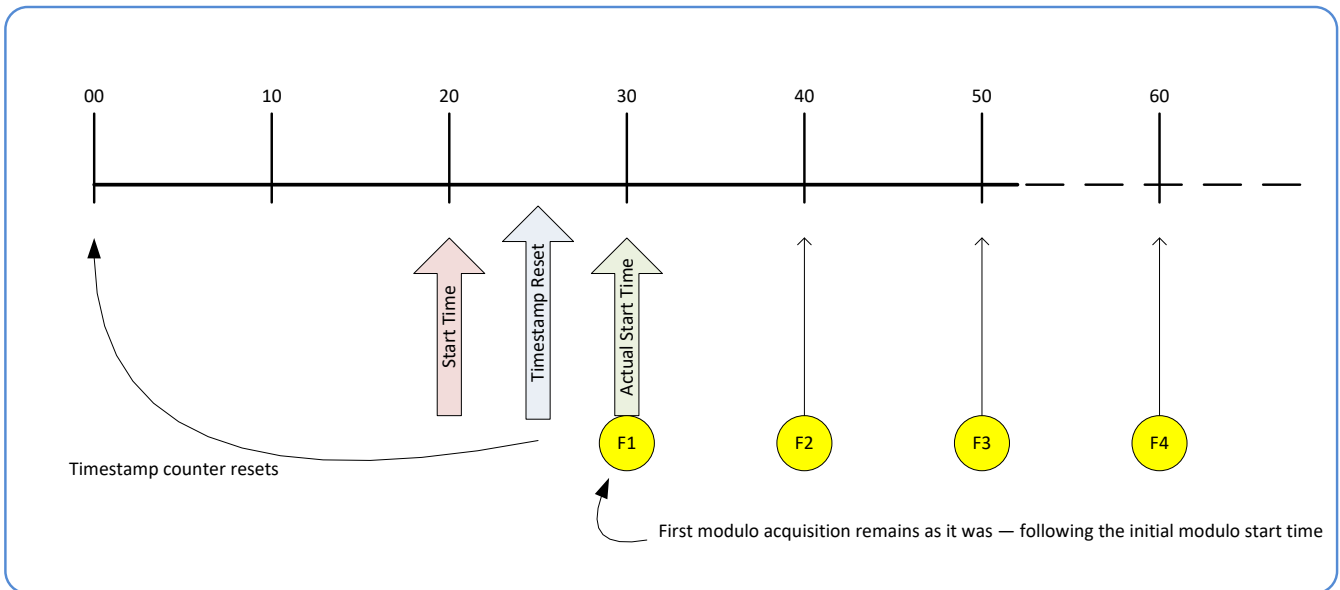

Case 4: Timer Reset after the Actual Start Time

Conditions:

- initial timestampControlReset resets Timestamp counter
- timestampModuloStartTime at 20
- timestampModulo = 10
- timestampModuloActualStartTime = first event (F1)
- second timestampControlReset at 35

This case describes the Modulo process if there is a Timestamp counter reset after a modulo controlled acquisition occurs.

- "A" shows the initial conditions with the first acquisition (F1) at the actual start time.
- "B" shows a Timestamp reset occurring after the first acquisition.
- "C" shows that acquisitions then continue at the first modulo 10 time after the reset due to acquisitions already in progress compared to the example case 3 above.

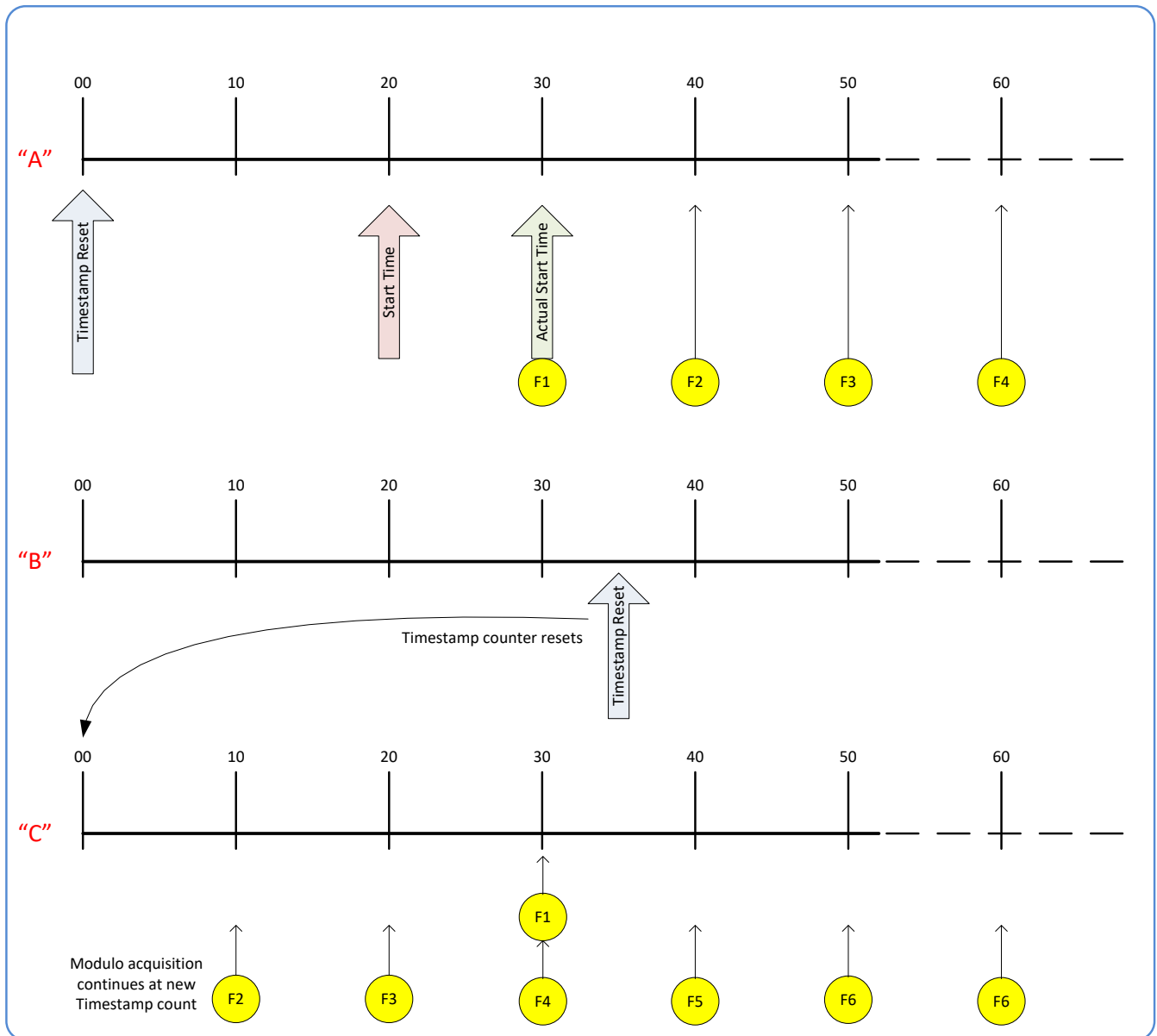

Case 5: Changing 'timestampModulo' during Acquisitions

Conditions:

- initial timestampControlReset resets Timestamp counter
- timestampModuloStartTime at 20
- timestampModulo = 10
- timestampModuloActualStartTime = first event (F1)
- timestampModulo changes to 20

Case 5 shows that the Modulo value can be changed dynamically. Using the simple example of case 1, after the second acquisition (F2) the Modulo value is changed from 10 to 20. The third acquisition now occurs at modulo 20 time following the previous acquisition.

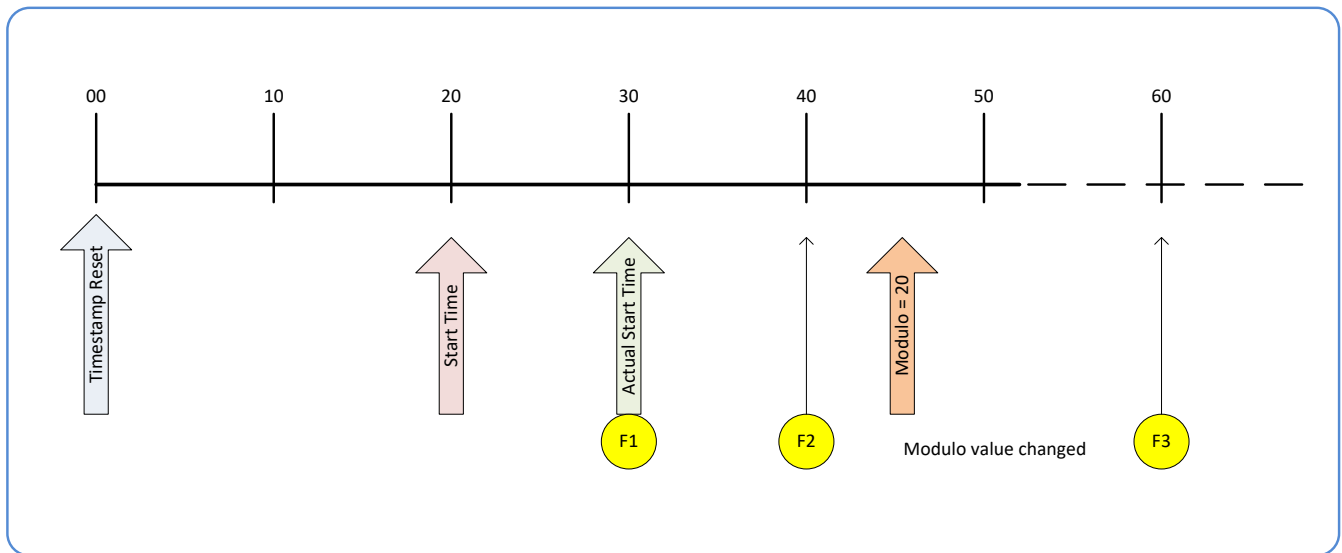

GigE Vision Transport Layer Control Category

The Genie Nano GigE Vision Transport Layer control, as shown by CamExpert, has parameters used to configure features related to GigE Vision specification and the Ethernet Connection. Parameters in gray are read only, either always or due to another parameter being disabled. Parameters in black are user set in CamExpert or programmable via an imaging application.

Features listed in the description table but tagged as *Invisible* are usually for Teledyne DALSA or third party software usage—not typically needed by end user applications. Also important, Genie Nano cameras are available in a number of models implementing different sensors and image resolutions which may not support the full feature set defined in this category.

Category	Parameter	Value
Camera Information	Device Link Selector	0
<input checked="" type="checkbox"/> Sensor Control	Device Link Throughput Limit	On
Auto-Brightness	Device Link Throughput Limit (in Bps)	115000000
I/O Controls	Stream Channel Selector	0
Counter And Timer Control	Device Link Speed (in Mbps)	1000
<input checked="" type="checkbox"/> Advanced Processing	PacketSize	9000
Color Processing	Interpacket Delay	7
Cycling Preset	Packet Resend Buffer Size	6.0
Image Format Controls	IP Configuration Status	DHCP
<input checked="" type="checkbox"/> Metadata Controls	Current IP Address	172.16.239.6
Chunk Parser	Current Subnet Mask	255.255.255.0
Acquisition and Transfer Cont...	Current Default Gateway	0.0.0.0
Action Control	Current IP set in LLA	True
<input checked="" type="checkbox"/> Event Control	Current IP set in DHCP	True
<input checked="" type="checkbox"/> Event Info	Current IP set in PersistentIP	False
GigE Vision Transport Layer	Primary Application IP Address	172.16.239.1
File Access Control	Device Access Privilege Control	Exclusive Access
GigE Vision Host Controls	Current Heartbeat Timeout	3000
	GVCP Heartbeat Disable	Not Enabled
	Communication Timeout (in msec)	0
	Communication Retransmissions Count	0
	<< Less	

GigE Vision Transport Layer Feature Descriptions

The following table describes these parameters along with their view attribute and minimum camera firmware version required. Additionally the Device Version column will indicate which parameter is a member of the DALSA Features Naming Convention (denoted by DFNC), versus the GenICam Standard Features Naming Convention (SFNC tag is not shown).

The Device Version number represents the camera software functional group, not a firmware revision number. As Genie Nano capabilities evolve the device version tag will increase, therefore identifying the supported function package. New features for a major device version release will be indicated by **green text** for easy identification.

Display Name	Feature & Values	Description	Device Version & View
Device Link Selector	DeviceLinkSelector	Selects which Link of the device to control	1.00 Expert
Device Link Throughput Limit	DeviceLinkThroughputLimitMode	When disabled, lower level TL specific features are expected to control the throughput. When enabled, DeviceLinkThroughputLimit controls the overall throughput.	1.00 Guru
Device Link Throughput Limit	DeviceLinkThroughputLimit	Limits the maximum bandwidth of the data that will be streamed out by the device.	1.03 Guru
Stream Channel Selector	GevStreamChannelSelector	Selects the stream channel to control.	1.00 Expert
Device Link Speed	GevLinkSpeed	Indicates the transmission speed negotiated by the given network interface.	1.00 Expert
PacketSize	GevSCPSPacketSize	Specifies the stream packet size in bytes to send on this channel.	1.00 Expert
Interpacket Delay	GevSCPD	Indicates the delay (in μ s) to insert between each packet for this stream channel. Note that Interpacket delay becomes a Read-Only value when the feature "Device Link Throughput Limit" is enable.	1.00 Expert
Packet Resend Buffer Size	devicePacketResendBufferSize	Indicates the amount of memory to reserve in Mbytes for the packet resend buffer. Changes in reserved memory affects total memory available for acquisition buffering.	1.00 DFNC Guru
IP Configuration Status	GevIPConfigurationStatus	Reports the current IP configuration status. (RO)	1.00 Guru
<i>None</i>	<i>None</i>	<i>Device IP Configuration is not defined.</i>	
<i>PersistentIP</i>	<i>PersistentIP</i>	<i>Device IP Address Configuration is set to Persistent IP (static).</i>	
<i>DHCP</i>	<i>DHCP</i>	<i>Device IP Address Configuration is set to DHCP (Dynamic Host Configuration Protocol). Network requires a DHCP server.</i>	
<i>LLA</i>	<i>LLA</i>	<i>Device IP Address Configuration is set to LLA (Link-Local Address). Also known as Auto-IP. Used for unmanaged networks including direct connections from a device to a dedicated NIC.</i>	
<i>ForceIP</i>	<i>ForceIP</i>	<i>Device IP Address Configuration is set to ForceIP. Used to force an IP address change.</i>	
Current IP Address	GevCurrentIPAddress	Reports the IP address for the given network interface.	1.00 Beginner
Current Subnet Mask	GevCurrentSubnetMask	Reports the subnet mask of the given interface.	1.00 Beginner
Current Default Gateway	GevCurrentDefaultGateway	Reports the default gateway IP address to be used on the given network interface.	1.00 Beginner
Current IP set in LLA	GevCurrentIPConfigurationLLA	Controls whether the LLA (Link Local Address) IP configuration scheme is activated on the given network interface.	1.00 Guru
Current IP set in DHCP	GevCurrentIPConfigurationDHCP	Controls whether the DHCP IP configuration scheme (Dynamic Host Configuration Protocol) is activated on the given network interface.	1.00 Guru
Current IP set in PersistentIP	GevCurrentIPConfigurationPersistentIP	Controls whether the PersistentIP configuration scheme is activated on the given network interface.	1.00 Guru
Primary Application IP Address	GevPrimaryApplicationIPAddress	Returns the IP address of the device hosting the primary application. (RO)	1.00 Guru

Device Access Privilege Control	deviceCCP	Controls the device access privilege of an application.	1.00 Guru DFNC
<i>Exclusive Access</i>	<i>ExclusiveAccess</i>	<i>Grants exclusive access to the device to an application. No other application can control or monitor the device.</i>	
<i>Control Access</i>	<i>ControlAccess</i>	<i>Grants control access to the device to an application. No other application can control the device.</i>	
<i>Control Access Switchover Active</i>	<i>ControlAccessSwitchoverActive</i>	<i>Enables another application to request control access to the device.</i>	
Discovery Acknowledge Delay	GevDiscoveryAckDelay	Indicates the maximum randomized delay the device will wait to acknowledge a discovery command. (RO)	1.00 Guru
Current Heartbeat Timeout	GevHeartbeatTimeout	Indicates the current heartbeat timeout in milliseconds.	1.00 Guru
GVCP Heartbeat Disable	GevGVCPHeartbeatDisable	Disables the GVCP (GigE Vision Control Protocol) heartbeat monitor. This allows control switchover to an application on another device.	1.00 Expert
Communication Timeout	GevMCTT	Provides the transmission timeout value in milliseconds.	1.00 Guru
Communication Retransmissions Count	GevMCRC	Indicates the number of retransmissions allowed when a message channel message times out.	1.00 Guru
I GVSP Extended ID Mode	GevGVSPExtendedIDMode	Enables the extended ID mode.	1.00 Expert
Fire Test Packet	GevSCPSFireTestPacket	When this feature is set to True, the device will fire one test packet.	1.00 Invisible
Payload Size	PayloadSize	Provides the number of bytes transferred for each image or chunk on the stream channel.	1.00 Invisible
MAC Address	GevMACAddress	MAC address of the network interface.	1.00 Invisible
Current Camera IP Configuration	GevCurrentIPConfiguration	Current camera IP configuration of the selected interface.	1.00 Invisible
<i>LLA</i>	<i>LLA</i>	<i>Link-Local Address Mode</i>	
<i>DHCP</i>	<i>DHCP</i>	<i>Dynamic Host Configuration Protocol Mode. Network requires a DHCP server.</i>	
<i>PersistentIP</i>	<i>PersistentIP</i>	<i>Persistent IP Mode (static)</i>	
Persistent IP Address	GevPersistentIPAddress	Persistent IP address for the selected interface. This is the IP address the camera uses when booting in Persistent IP mode.	1.00 Invisible
Persistent Subnet Mask	GevPersistentSubnetMask	Persistent subnet mask for the selected interface.	1.00 Invisible
Persistent Default Gateway	GevPersistentDefaultGateway	Persistent default gateway for the selected interface.	1.00 Invisible
Primary Application Socket	GevPrimaryApplicationSocket	Returns the UDP (User Datagram Protocol) source port of the primary application.	1.00 Invisible
Device Access Privilege Control	GevCCP	Controls the device access privilege of an application.	1.00 Invisible
<i>Open Access</i>	<i>OpenAccess</i>	<i>OpenAccess</i>	
<i>Exclusive Access</i>	<i>ExclusiveAccess</i>	<i>Grants exclusive access to the device to an application. No other application can control or monitor the device.</i>	
<i>Control Access</i>	<i>ControlAccess</i>	<i>Grants control access to the device to an application. No other application can control the device.</i>	
<i>Control Access Switchover Active</i>	<i>ControlAccessSwitchoverActive</i>	<i>Enables another application to request control access to the device.</i>	

Interface Selector	GevInterfaceSelector	Selects which physical network interface to control.	1.00 Invisible
Number Of Interfaces	GevNumberOfInterfaces	Indicates the number of physical network interfaces supported by this device. (RO)	1.00 Invisible
Message Channel Count	GevMessageChannelCount	Indicates the number of message channels supported by this device. (RO)	1.00 Invisible
Stream Channel Count	GevStreamChannelCount	Indicates the number of stream channels supported by this device (0 to 512). (RO)	1.00 Invisible
I Supported Option Selector	GevSupportedOptionSelector	Selects the I option to interrogate for existing support. (RO)	1.00 Invisible
	<i>IPConfigurationLLA IPConfigurationDHCP IPConfigurationPersistentIP StreamChannelSourceSocket MessageChannelSourceSocket CommandsConcatenation WriteMem PacketResend Event EventData PendingAck Action PrimaryApplicationSwitchover ExtendedStatusCodes DiscoveryAckDelay DiscoveryAckDelayWritable TestData ManifestTable CCPApplicationSocket LinkSpeed HeartbeatDisable SerialNumber UserDefinedName StreamChannelIOBigAndLittleEndian StreamChannelIPIPReassembly StreamChannelIOUnconditionalStreaming StreamChannelIOExtendedChunkData</i>		
I Supported Option	GevSupportedOption	Returns TRUE if the selected I option is supported. (RO)	1.00 Invisible
LLA Supported	GevSupportedIPConfigurationLLA	Indicates if LLA (Auto-IP) is supported by the selected interface. The LLA method automatically assigns the Nano with a randomly chosen address on the 169.254.xxx.xxx subnet. After an address is chosen, the link-local process sends an ARP query with that IP onto the network to see if it is already in use. If there is no response, the IP is assigned to the device, otherwise another IP is selected, and the ARP is repeated. Note that LLA is unable to forward packets across routers. LLA is the recommended scheme when only one NIC is connected to GigE cameras; ensure only one NIC is using LLA on your PC, otherwise IP conflicts will result. (RO)	1.00 Invisible
DHCP Supported	GevSupportedIPConfigurationDHCP	Indicates if DHCP is supported by the selected interface. This IP configuration mode requires a DHCP server to allocate an IP address dynamically over the range of some defined subnet. The Nano must be configured to have DHCP enabled. This is the factory default settings. The DHCP server is part of a managed network. Windows itself does not provide a DHCP server function therefore a dedicated DHCP server is required. The DALSA Network Configuration Tool can be configured as a DHCP server on the NIC used for the GigE Vision network. (RO)	1.00 Invisible

Persistent IP Supported	GevSupportedIPConfigurationPersistentIP	Indicates if Persistent IP is supported by the selected interface. This protocol is only suggested if the user fully controls the assignment of IP addresses on the network and a GigE Vision camera is connected beyond routers. The GigE Vision camera is forced a static IP address. The NIC IP address must use the same subnet otherwise the camera is not accessible. If the Nano camera is connected to a network with a different subnet, it cannot be accessed. (RO)	1.00 Invisible
GVCP Extended Status Codes	GevGVCPExtendedStatusCodes	Enables generation of extended status codes. (RO)	1.00 Invisible
GVCP Pending Timeout	GevGVCPPendingTimeout	Indicates the longest GVCP command execution time before a device returns a PENDING_ACK.	1.00 Invisible
I MCP HostPort	GevMCPHostPort	Indicates the port to which the device must send messages. (RO)	1.00 Invisible
I MCDA	GevMCDA	Indicates the destination IP address for the message channel. (RO)	1.00 Invisible
I MCSP	GevMCSP	This feature indicates the source port for the message channel. (RO)	1.00 Invisible
Stream Channel Interface Index	GevSCPIInterfaceIndex	Index of network interface. (RO)	1.00 Invisible
I SCP HostPort	GevSCPHostPort	Indicates the port to which the device must send the data stream. (RO)	1.00 Invisible
I SCDA	GevSCDA	Indicates the destination IP address for this stream channel. (RO)	1.00 Invisible
I SCSP	GevSCSP	Indicates the source port of the stream channel. (RO)	1.00 Invisible
I First URL	GevFirstURL	Indicates the first URL to the XML device description file.	1.00 Invisible
I Second URL	GevSecondURL	Indicates the second URL to the XML device description file.	1.00 Invisible
I Major Version	GevVersionMajor	Major version of the specification.	1.00 Invisible
I Minor Version	GevVersionMinor	Minor version of the specification.	1.00 Invisible
Manifest Entry Selector	DeviceManifestEntrySelector	Selects the manifest entry to reference.	1.00 Invisible
XML Major Version	DeviceManifestXMLMajorVersion	Indicates the major version number of the XML file of the selected manifest entry.	1.00 Invisible
XML Minor Version	DeviceManifestXMLMinorVersion	Indicates the Minor version number of the XML file of the selected manifest entry.	1.00 Invisible
XML SubMinor Version	DeviceManifestXMLSubMinorVersion	Indicates the SubMinor version number of the XML file of the selected manifest entry.	1.00 Invisible
Schema Major Version	DeviceManifestSchemaMajorVersion	Indicates the major version number of the Schema file of the selected manifest entry.	1.00 Invisible
Schema Minor Version	DeviceManifestSchemaMinorVersion	Indicates the minor version number of the Schema file of the selected manifest entry.	1.00 Invisible
Manifest Primary URL	DeviceManifestPrimaryURL	Indicates the first URL to the XML device description file of the selected manifest entry.	1.00 Invisible
Manifest Secondary URL	DeviceManifestSecondaryURL	Indicates the second URL to the XML device description file of the selected manifest entry.	1.00 Invisible
Device Mode Is Big Endian	GevDeviceModeIsBigEndian	Endianess of the device registers.	1.00 Invisible
Device Mode CharacterSet	GevDeviceModeCharacterSet	Character set used by all the strings of the bootstrap registers.	1.00 Invisible

		<i>reserved1</i> <i>UTF8</i> <i>reserved2</i>	
GevSCPSDoNotFragment	GevSCPSDoNotFragment	This feature state is copied into the "do not fragment" bit of IP header of each stream packet. (RO)	1.00 Invisible
I SCPS BigEndian	GevSCPSBigEndian	Endianess of multi-byte pixel data for this stream. (RO)	1.00 Invisible

Defaults for devicePacketResendBufferSize

The default minimum for devicePacketResendBufferSize allows at least two maximum sized buffer. Resend buffers hold the last images that have been transferred to host. More buffers allow more possible resend packets.

But it is important to remember that increasing the packet resend buffer value consumes internal memory used for image buffers waiting to transfer. This will reduce the number of frames acquired at frame rates exceeding the transfer rates possible to the host computer. Memory size is monitored with the feature "[transferQueueMemorySize](#)".

GigE Vision Host Control Category

The GigE Vision Host controls as shown by CamExpert, has parameters used to configure the host computer system GigE Vision features used for Genie Nano networking management. None of these parameters are stored in any Genie Nano camera.

These features allow optimizing the network configuration for maximum Nano bandwidth. Settings for these parameters are highly dependent on the number of cameras connected to a NIC, the data rate of each camera and the trigger modes used.

Information on these features is found in the Teledyne DALSA Network Imaging Module User manual.

Teledyne DALSA TurboDrive

For Genie Nano cameras supporting TurboDrive, ensure to set the feature “*Turbo Transfer Mode*” to *True*.

For information on TurboDrive see our technology primer:

<http://www.teledynedalsa.com/imaging/knowledge-center/appnotes/turbo-drive/>

Plus this application note reviews Teledyne DALSA’s continued development of TurboDrive:

G3-AN0004 – Genie Nano: Comparing TurboDrive v2.0 with TurboDrive v1.0 algorithm

<http://www.teledynedalsa.com/imaging/knowledge-center/appnotes/>

Important: When using Metadata in conjunction with TurboDrive, the Nano driver (all models) requires that the image acquisition width (horizontal crop) must be a minimum of 160 pixels in 8-bit mode or 96 pixels in 10/12-bit mode. The driver requires this minimum width to correctly apply the TurboDrive compression algorithm. When acquisitions are cropped more than the minimum widths, TurboDrive is automatically disabled while Metadata remains active.

File Access Control Category

The File Access control in CamExpert allows the user to quickly upload various data files to the connected Genie Nano. The supported data files are for firmware updates, and dependent on the Nano model, LUT tables, Defective Pixel Maps, and other Sapera file types.

Features listed in the description table but tagged as *Invisible* are usually for Teledyne DALSA or third party software usage—not typically needed by end user applications.

Also important, Genie Nano cameras are available in a number of models implementing different sensors and image resolutions which may not support the full feature set defined in this category.

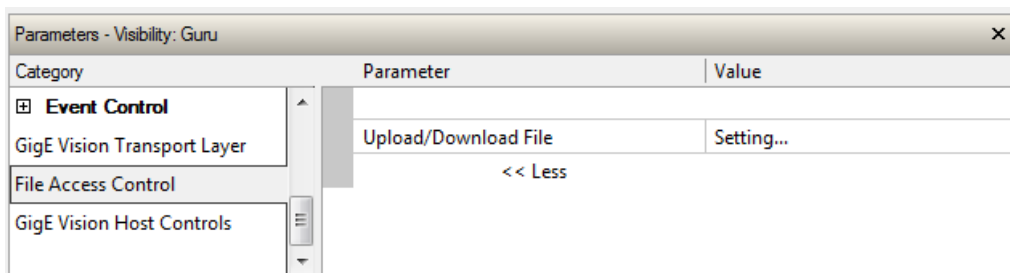

File Access Control Feature Descriptions

The Device Version number represents the camera software functional group, not a firmware revision number. As Genie Nano capabilities evolve the device version tag will increase, therefore identifying the supported function package. New features for a major device version release will be indicated by **green text** for easy identification.

Display Name	Feature & Values	Description	Device Version various Models	Device Version NanoXL
File Selector	FileSelector	Selects the file to access. The file types which are accessible are device-dependent. < Guru >	1.00	1.06
<i>Firmware</i>	<i>Firmware1</i>	<i>Upload new firmware to the camera which will execute on the next camera reboot cycle. Select the DeviceReset feature after the upload completes.</i>		
<i>LUT Luminance 1</i>	<i>LutLuminance1</i>	<i>Select to write (upload) a Look-up-Table file (Sapera .LUT file) into the camera's internal LUT Luminance 1.</i>		
<i>LUT RGB</i>	<i>LutRGB</i>	<i>Select to write (upload) a Look-up-Table file (Sapera .LUT file) into the camera's internal RGB LUT.</i>	1.04	
<i>LUT Raw Bayer 1</i>	<i>LutRawBayer1</i>	<i>Select to write (upload) a Look-up-Table file (Sapera .LUT file) into the camera's internal LUT Raw Bayer 1.</i>		
<i>Factory Defective Pixel Map</i>	<i>BadPixelCoordinate0</i>	<i>Select the Factory Defective Pixel Map.</i>	1.04	1.06
<i>User Defective Pixel Map</i>	<i>BadPixelCoordinate1</i>	<i>Select the User Defective Pixel Map XML file as defined in Advanced Processing.</i>	1.04	1.06
Color Correction Coefficients	<i>ColorCorrection</i>	<i>Select the color correction coefficients (RGB Output Firmware).</i>	1.06	1.06
<i>Factory Flat Line coefficients 1</i>	<i>FlatFieldCoefficients01</i>	<i>Select factory Flat Line coefficients 1. These are the factory values used when the camera fastReadoutMode is Off and sensor Gain is 1.0.</i>	—	1.06
<i>Factory Flat Line coefficients 2</i>	<i>FlatFieldCoefficients02</i>	<i>Select factory Flat Line coefficients 2. These are the factory values used when the camera fastReadoutMode is Off and sensor Gain is 1.26.</i>	—	1.06
<i>Factory Flat Line coefficients 3</i>	<i>FlatFieldCoefficients03</i>	<i>Select factory Flat Line coefficients 3. These are the factory values used when the camera fastReadoutMode is Off and sensor Gain is 1.87.</i>	—	1.06
<i>Factory Flat Line coefficients 4</i>	<i>FlatFieldCoefficients04</i>	<i>Select factory Flat Line coefficients 4. These are the factory values used when the camera fastReadoutMode is Off and sensor Gain is 3.17.</i>	—	1.06
<i>Factory Flat Line coefficients 5</i>	<i>FlatFieldCoefficients05</i>	<i>Select factory Flat Line coefficients 5. These are the factory values used when the camera fastReadoutMode is Active and sensor Gain is 1.0.</i>	—	1.06
<i>Factory Flat Line coefficients 6</i>	<i>FlatFieldCoefficients06</i>	<i>Select factory Flat Line coefficients 6. These are the factory values used when the camera fastReadoutMode is Active and sensor Gain is 1.26.</i>	—	1.06

Factory Flat Line coefficients 7	FlatFieldCoefficients07	Select factory Flat Line coefficients7. These are the factory values used when the camera fastReadoutMode is Active and sensor Gain is 1.87.	—	1.06
Factory Flat Line coefficients 8	FlatFieldCoefficients08	Select factory Flat Line coefficients 8. These are the factory values used when the camera fastReadoutMode is Active and sensor Gain is 3.17.	—	1.06
User Flat Line coefficients 1	FlatFieldCoefficients1	Select user flatfield coefficients1. These are the coefficient values used when the sensor analog Gain is 1.0.	—	1.06
User Flat Line coefficients 2	FlatFieldCoefficients2	Select user flatfield coefficients2. These are the coefficient values used when the sensor Gain is 1.26.	—	1.06
User Flat Line coefficients 3	FlatFieldCoefficients3	Select user flatfield coefficients3. These are the coefficient values used when the sensor Gain is 1.87.	—	1.06
User Flat Line coefficients 4	FlatFieldCoefficients4	Select user flatfield coefficients4. These are the coefficient values used when the sensor Gain is 3.17.	—	1.06
User Defined Saved Image	userDefinedSavedImage	Upload and download an image in the camera.	1.04	1.06
Open Source Licenses	SoftwareLicenses	Open Source Software Licenses.	1.07	1.07
File Operation Selector	FileOperationSelector	Selects the target operation for the selected file in the device. This operation is executed when the File Operation Execute feature is called. < Guru >	1.00	1.06
Open	Open	Select the Open operation – executed by FileOperationExecute.		
Close	Close	Select the Close operation – executed by FileOperationExecute		
Read	Read	Select the Read operation – executed by FileOperationExecute.		
Write	Write	Select the Write operation – executed by FileOperationExecute.		
Delete	Delete	Select the Delete operation – executed by FileOperationExecute.		
File Operation Execute	FileOperationExecute	Executes the operation selected by File Operation Selector on the selected file. < Guru >	1.00	1.06
User Defined Saved Image	userDefinedSavedImage	Upload or download an image in the camera. < DFNC – Guru >	1.00	1.06
File Open Mode	FileOpenMode	Selects the access mode used to open a file on the device. < Guru >	1.00	1.06
Read	Read	Select READ only open mode		
Write	Write	Select WRITE only open mode		
File Access Buffer	FileAccessBuffer	Defines the intermediate access buffer that allows the exchange of data between the device file storage and the application. < Guru >	1.00	1.06
File Access Offset	FileAccessOffset	Controls the mapping offset between the device file storage and the file access buffer. < Guru >	1.00	1.06
File Access Length	FileAccessLength	Controls the mapping length between the device file storage and the file access buffer. < Guru >	1.00	1.06
File Operation Status	FileOperationStatus	Displays the file operation execution status. < Guru >	1.00	1.06
Success	Success	The last file operation has completed successfully.		

<i>Failure</i>	<i>Failure</i>	<i>The last file operation has completed unsuccessfully for an unknown reason.</i>		
<i>File Unavailable</i>	<i>FileUnavailable</i>	<i>The last file operation has completed unsuccessfully because the file is currently unavailable.</i>		
<i>File Invalid</i>	<i>FileInvalid</i>	<i>The last file operation has completed unsuccessfully because the selected file is not present in this camera model.</i>		
File Operation Result	FileOperationResult	Displays the file operation result. For Read or Write operations, the number of successfully read/written bytes is returned. < Guru >	1.00	1.06
File Size	FileSize	Represents the size of the selected file in bytes. < Guru >	1.00	1.06
Device User Buffer	deviceUserBuffer	Unallocated memory available to the user for data storage. < Invisible >	1.00 DFNC	1.06
User Defined Saved Image Max Size	userDefinedSavedImageMax Size	Maximum size of the user Defined Saved Image in the flash memory. < Invisible >	1.00 DFNC	1.06
Save Last Image to Flash	saveLastImageToFlash	Command that saves the last acquired image to camera flash memory. Use the file transfer feature to read the image from camera. Maximum image size is 1024x768 pixels in the Nano's model maximum pixel depth (monochrome or raw Bayer). < Invisible >	1.05 DFNC	1.06

Updating Firmware via File Access in CamExpert

- Click on the “Setting...” button to show the file selection menu.

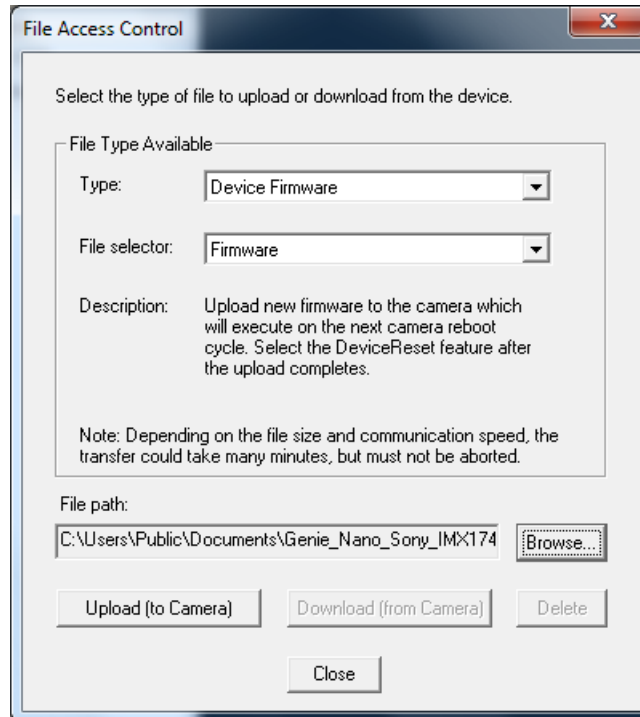

- From the **File Type** drop menu, select the file **Type** that will be uploaded to the Genie Nano. This CamExpert tool allows quick firmware changes or updates, when available for your Genie Nano model.
- From the **File Selector** drop menu, select the Genie Nano memory location for the uploaded data. This menu presents only the applicable data locations for the selected file type.
- Click the Browse button to open a typical Windows Explorer window.
- Select the specific file from the system drive or from a network location.
- Click the Upload button to execute the file transfer to the Genie Nano.
- Reset the Nano when prompted.

Overview of the *deviceUserBuffer* Feature

The feature *deviceUserBuffer* allows the machine vision system supplier access to 4 kB of reserved flash memory within the Genie Nano. This memory is available to store any data required, such as licensing codes, system configuration codes, etc. as per the needs of the system supplier. No Nano firmware operation will overwrite this memory block thus allowing and simplifying product tracking and control.

Overview of Color Correction Coefficients

The Sapura LT SDK provides a color correction tool and information about generating coefficients for color cameras with RGB output design firmware.

Open Source Software Licenses

The Spera CamExpert file access tool provides allows downloading the Open Source Software Licenses statement directly from the installed Nano firmware.

Select *File type Miscellaneous, File Selector item Open Source Licenses* to download the file to your computer. Add the file extension of .TXT and open with Notepad++, or add the extension .DOC and Microsoft Word will open it as a Unicode (UTF-8). Either of these methods will format the text correctly in Windows.

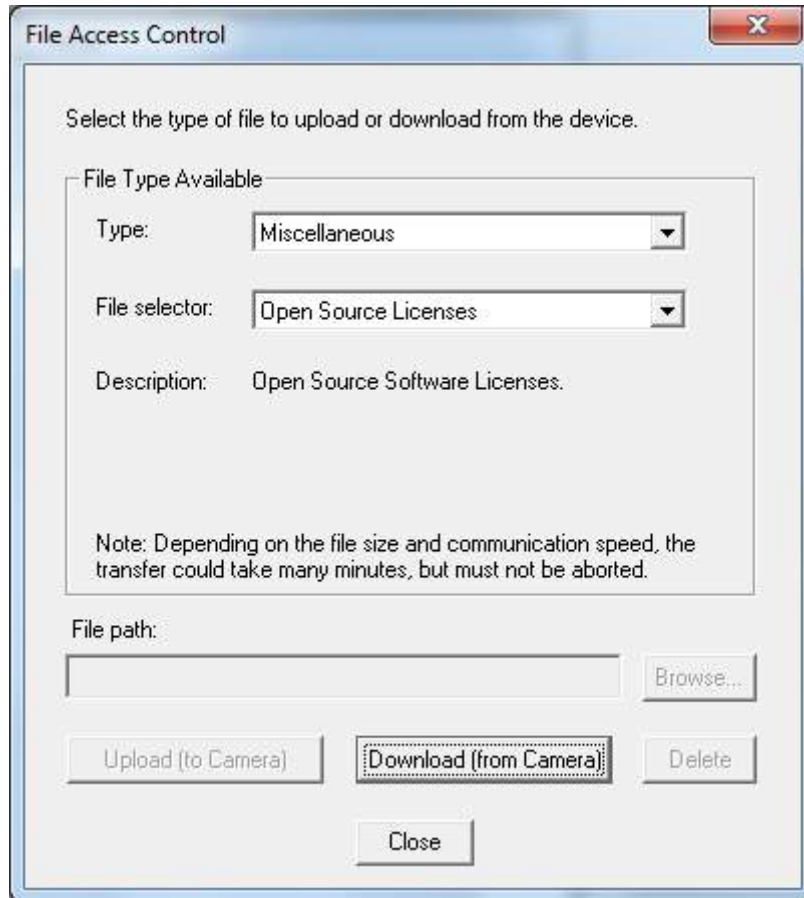

Implementing Trigger-to-Image Reliability

Overview

In a complex imaging system a lot can go wrong at all points – from initial acquisition, to camera processing, to data transmission. Teledyne DALSA provides features, events, and I/O signals that provide the system designer with the tools to qualify the system in real time.

The Teledyne DALSA website provides general information, FAQ, and White Paper download about the Trigger-to-Image Reliability (T2IR) framework in hardware and Sopera LT software SDK.

<http://www.teledynedalsa.com/imaging/knowledge-center/appnotes/t2ir/>

T2IR with Genie Nano

Nano provides a number of features for system monitoring:

- Built-in Self-Test on power-up and reset after firmware change
- Image Buffer Accumulation – Count Status
- Image Buffer Memory Size
- Packet Resend Buffer Memory Size
- Internal Temperature Reporting
- In Camera Event Status Flags
 - Invalid External Trigger
 - Image Lost
 - Packet Resend & Related Status
 - Ethernet Pause Frame Requested

Nano Features for T2IR Monitoring

The following table presents some of the Nano camera features a developer can use for T2IR monitoring. The output line signals would interface to other external devices.

Camera Status Monitoring	
Device Built-In Self Test	deviceBIST
Device Built-In Self Test Status	deviceBISTStatus
Device Temperature Selector	DeviceTemperatureSelector
Device Version	DeviceVersion
Firmware Version	DeviceFirmwareVersion
Last firmware update failed	FirmwareUpdateFailure
Manufacturer Part Number	deviceManufacturerPartNumber
Manufacturer Info	DeviceManufacturerInfo
Events	

Event Selector	EventSelector
Event Notification	EventNotification
Event Statistic Selector	eventStatisticSelector
Event Statistic Count	eventStatisticCount
Events Overflow	eventsOverflow
Event Statistic Count Reset	eventStatisticCountReset
Acquisition and Triggers	
Valid Frame Trigger	ValidFrameTrigger
Invalid Frame Trigger	InvalidFrameTrigger
Image Lost	ImageLost
Output Lines	
Pulse on: Valid Frame Trigger	PulseOnValidFrameTrigger
Pulse on: Rejected Frame(s) Trigger	PulseOnInvalidFrameTrigger
Image Transfers	
Transfer Queue Current Block Count	transferQueueCurrentBlockCount
Transfer Queue Memory Size	transferQueueMemorySize
Transferred Image Max Data Size	transferMaxBlockSize
Transferred Image Min Data Size	transferMinBlockSize
Transferred Image Average Data Size	transferAverageBlockSize
Maximum Sustained Frame Rate	maxSustainedFrameRate
Packet Resend	PacketResend
Packet Resend Request Dropped	PacketResendRequestDropped
Ethernet Pause Frame Received	EthernetPauseFrameReceived
Precision Time Protocol (PTP)	
PTP Status	ptpStatus
PTP Servo Status	ptpServoStatus
PTP Master Clock Identity	ptpMasterClockId
PTP Master Offset	ptpMasterOffsetNs
PTP Port Last Event	ptpPortLastEvent

Sapera Tools for Networking

Nano IP Configuration Mode Details

In general automatic IP configuration assignment (LLA/DHCP) is sufficient for most Nano installations. Please refer to the **Teledyne DALSA Network Imaging Package manual** for information on the Teledyne DALSA Network Configuration tool and network optimization for GigE Vision cameras and devices.

Technical Specifications

Both 2D and 3D design drawings are available for download from the Teledyne DALSA web site [<http://www.teledynedalsa.com/genie-nano>].

Mechanical Specifications — C & CS Mount:

Nano models with C and CS mounts have slight variations to their body depths as detailed in the following table. The three columns labeled “E”, “F”, and “G” list the dimensional depth variations (in mm) corresponding to the same labels shown on the mechanical specification drawing shown on the next page.

These physical variations compensate for different sensors boards and whether a model is shipped with an IR filter, so as to maintain a constant back focal specification. See this technical description for [information on back focal variances](#) when using IR or other filters between the lens and sensor.

MODELS	E (C MOUNT)	F (CS MOUNT)	G
M 1940, M 1920, C 1940, C 1920	MAX 40.3 / MIN 38.8	N/A	MAX 19.7 / MIN 17.8
M 1941, M 1921, C 1941, C 1921	N/A	MAX 35.3 / MIN 33.8	MAX 19.7 / MIN 17.8
C 1940IF, C 1920IF	MAX 40.6 / MIN 39.1	N/A	MAX 20.0 / MIN 18.1
C 1941IF, C 1921IF	N/A	MAX 35.6 / MIN 34.1	MAX 20.0 / MIN 18.1
M 1280, M 800, M 640, C 1280, C 800, C 640	MAX 40.6 / MIN 39.1	N/A	MAX 20.0 / MIN 18.1
M 1281, M 801, M 641, C 1281, C 801, C 641	N/A	MAX 35.6 / MIN 34.1	MAX 20.0 / MIN 18.1
C 1280IF, C 800IF, C 640IF	MAX 40.9 / MIN 39.4	N/A	MAX 20.3 / MIN 18.4
C 1281IF, C 801IF, C 641IF	N/A	MAX 35.9 / MIN 34.4	MAX 20.3 / MIN 18.4
M 2590, M 1930, C 2590, C 1930	MAX 40.6 / MIN 39.1	N/A	MAX 20.0 / MIN 18.1
M 2591, M 1931, C 2591, C 1931	N/A	MAX 35.6 / MIN 34.1	MAX 20.0 / MIN 18.1
C 2590IF, C 1930IF	MAX 40.9 / MIN 39.4	N/A	MAX 20.3 / MIN 18.4
C 2591IF, C 1931IF	N/A	MAX 35.9 / MIN 34.4	MAX 20.3 / MIN 18.4
M 2450, M 2420, M 2050, M 2020, C 2450, C 2420, C 2050, C 2020	MAX 40.3 / MIN 38.8	N/A	MAX 19.7 / MIN 17.8
M 2451, M 2421, M 2051, M 2021, C 2451, C 2421, C 2051, C 2021	N/A	MAX 35.3 / MIN 33.8	MAX 19.7 / MIN 17.8
C 2450IF, C 2420IF, C 2050IF, C 2020IF	MAX 40.6 / MIN 39.1	N/A	MAX 20.0 / MIN 18.1
C 2451IF, C 2421IF, C 2051IF, C 2021IF	N/A	MAX 35.6 / MIN 34.1	MAX 20.0 / MIN 18.1
M 4020, M 4030, M 4040, M 4060, C 4020, C 4030, C 4040, C 4060	MAX 40.3 / MIN 38.8	N/A	MAX 19.7 / MIN 17.8
M 4021, M 4031, M 4041, M 4061, C 4021, C 4031, C 4041, C 4061	N/A	MAX 35.3 / MIN 33.8	MAX 19.7 / MIN 17.8
C 4020IF, C 4030IF, C 4040IF, C 4060IF	MAX 40.6 / MIN 39.1	N/A	MAX 20.0 / MIN 18.1
C 4021IF, C 4031IF, C 4041IF, C 4061IF	N/A	MAX 35.6 / MIN 34.1	MAX 20.0 / MIN 18.1

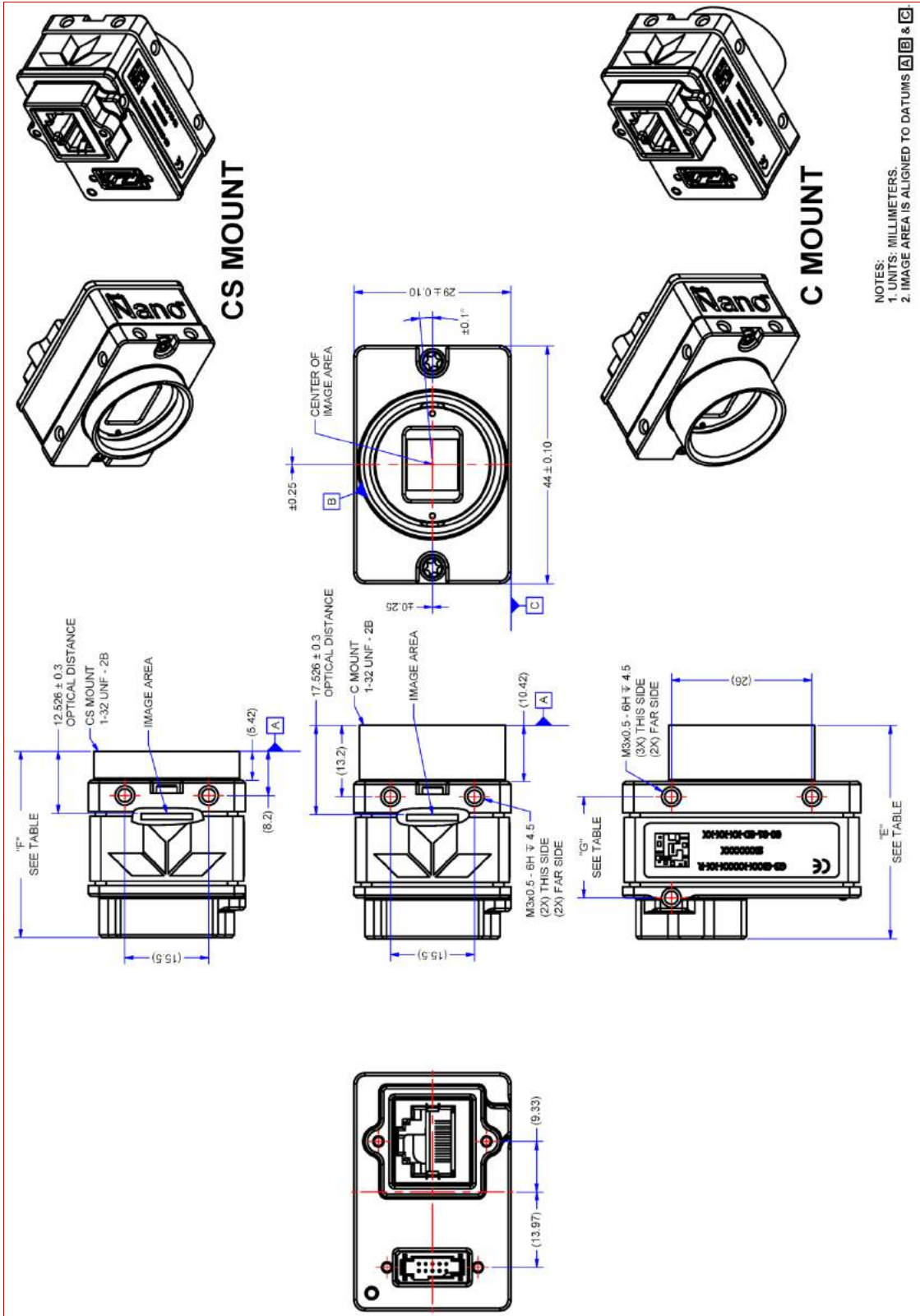

Note: Genie Nano with C or CS Mount

Mechanical Specifications — NanoXL:

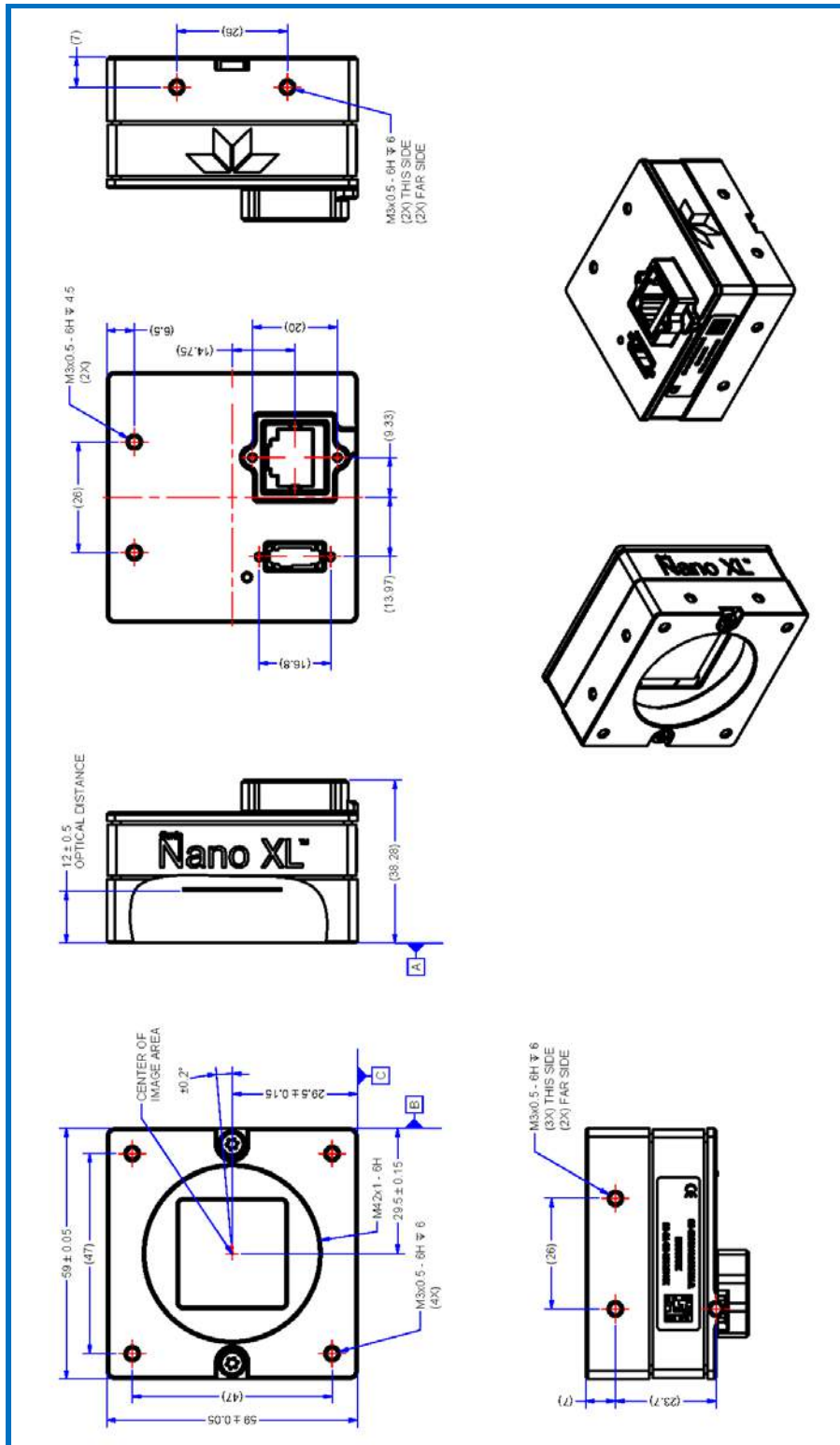

Note: Genie NanoXL with M42 Mount

Additional Notes on Genie Nano Identification and Mechanical

Identification Label

	<p>Genie Nano cameras have an identification label applied to the bottom side, with the following information:</p> <ul style="list-style-type: none"> Model Part Number Serial number MAC ID 2D Barcode CE and FCC logo
---	--

Additional Mechanical Notes

	<p>Nano supports a screw lock Ethernet cable as described in Ruggedized RJ45 Ethernet Cables. For information on Nano lens requirements see Optical Considerations. Each camera side has two mounting holes in identical locations, which provide good grounding capabilities. Overall height or width tolerance is $\pm 0.05\text{mm}$.</p>
---	---

Temperature Management

Genie Nano cameras are designed to optimally transfer internal component heat to the outer metallic body. If the camera is free standing (i.e. not mounted) it will be very warm to the touch.

Basic heat management is achieved by mounting the camera onto a metal structure via its mounting screw holes. Heat dissipation is improved by using thermal paste between the camera body (not the front plate) and the metal structure.

Sensor Alignment Specification

The following figure specifies sensor alignment for Genie Nano where all specifications define the absolute maximum tolerance allowed for production cameras. Dimensions "x, y, z", are in microns and referenced to the Genie Nano mechanical body or the optical focal plane (for the z-axis dimension). Theta specifies the sensor rotation relative to the sensor's center and Nano mechanical.

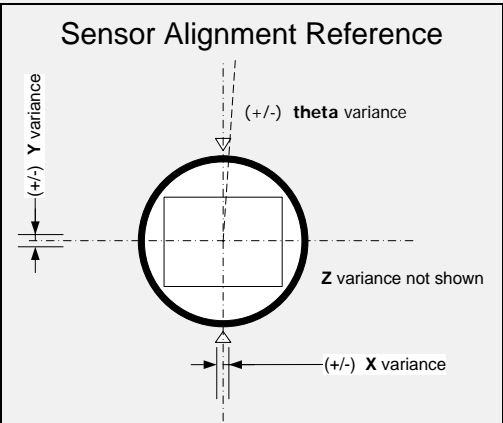
X variance	+/- 250 microns	 <p>Sensor Alignment Reference</p> <p>The diagram shows a square sensor centered within a circle. A vertical dashed line represents the Z-axis, with a label 'Z variance not shown'. A horizontal dashed line represents the X-axis, with a label '(+/-) X variance'. A vertical double-headed arrow on the left represents the Y-axis, with a label '(+/-) Y variance'. An angle between a vertical dashed line and a solid line passing through the center of the sensor is labeled '(+/-) theta variance'.</p>
Y variance	+/- 250 microns	
Z variance	+/- 300 microns	
Theta variance	+/- 1 degree	

Connectors

- A single **RJ45 Ethernet** connector for control and video data to the host Gigabit NIC. Additionally for [PoE](#), the Genie Nano requires an appropriate PoE Class 0 or Class 3 (or greater) power source device (such as a powered computer NIC, or a powered Ethernet switch, or an Ethernet power injector). For industrial environments, Nano supports the use of screw lock Ethernet cables (see Ruggedized RJ45 Ethernet Cables). Note that for PoE installations, a shielded Ethernet cable is required to provide a camera ground connection to the controlling computer.
- Note: Connect power via the I/O or PoE, **not both**. Although Nano has protection, differences in ground levels may cause operational issues or electrical faults.
- The Nano has a single 10-pin connector (SAMTEC connector TFM-105-02-L-D-WT) for all I/O signals and for an auxiliary DC power source. Nano supports connecting cables with retention clips or screw locks.
- See [I/O Mating Connector Sources](#) for information about the mating connector or complete cable solutions with retention clips. The following figure shows the pin number assignment (external view of the camera body connector).

Face View of the Nano Back

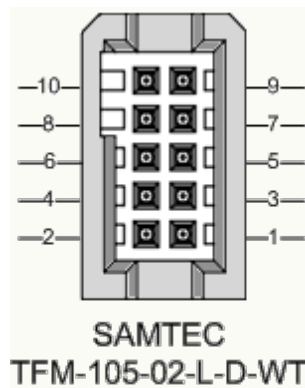

3D View of the camera's connector TFM-105-02-L-D-WT

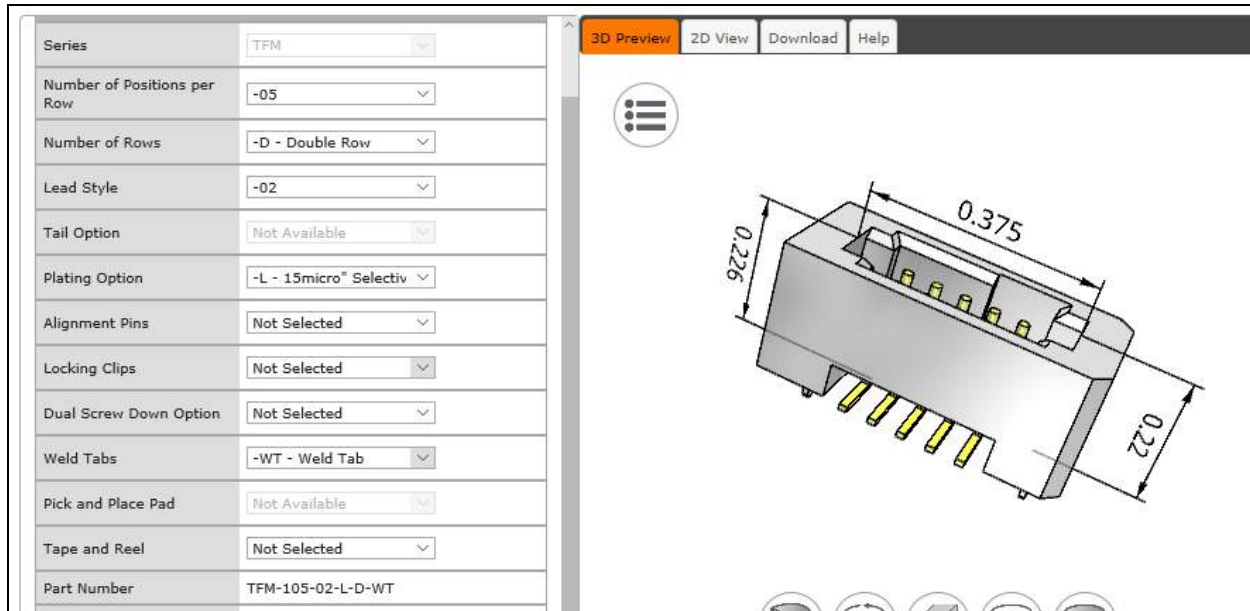

10-pin I/O Connector Details

Teledyne DALSA makes available optional I/O cables as described in Accessories. Contact Sales for availability and pricing.

Pin Number	Genie Nano	Direction	Definition
1	PWR-GND	—	Camera Power – Ground
2	PWR-VCC	—	Camera Power – DC +10 to +36 Volts
3	GPI-Common	—	General Input Common Ground
4	GPO-Power	—	General Output Common Power
5	GPI 1	In	General External Input 1
6	GPO 1	Out	General External Output 1
7	GPI 2	In	General External Input 2
	<i>Reserved</i>	—	<i>N/A for G3-Gx2 or G3-Gx3 ... models ‡</i>
8	GPO 2	Out	General External Output 2
9	<i>Reserved</i>		
	GPO 3	Out	<i>General External Output 3 for G3-Gx2 or G3-Gx3 ‡</i>
10	Chassis		Camera Chassis

‡ Note: Output 3 only supports Software Controlled logic High or Low signals.

Nano: “G3-GM2... or G3-GC2...” part numbers denote optional “1 input / 3 output” special order models.

NanoXL: “G3-Gx3” models come standard with 2 Inputs and 3 Outputs

See [AC Characteristics of 1 Input / 3 Output Models](#) for additional information.

Camera DC Power Characteristics

DC Operating Characteristics		
Input Voltage	+10 Volts minimum	
Input Power Consumption	@ +12 Volt Supply	3.99 Watts typical
Input Power Consumption	@ +24 Volt Supply	3.96 Watts typical
Input Power Consumption	@ +48 Volt Supply	4.22 Watts typical

Absolute Maximum DC Power Supply Range before Possible Device Failure		
Input Voltage	–58 Volt DC	+58 Volts DC

I/O Mating Connector Specifications & Sources

For users wishing to build their own custom I/O cabling, the following product information is provided to expedite your cable solutions. Samtec web information for the discrete connector and a cable assembly with retention clips follows the table.

MFG	Part #	Description	Data Sheet
Samtec	ISDF-05-D ISDF-05-D-M (see image below)	Discrete Connector (see example below)	https://www.samtec.com/products/isdf
Samtec	SFSD-05-[WG]-G-[AL]-DR-[E2O] WG : Wire Gauge AL : Assembled Length E2O : End 2 Option	Discrete Cable Assembly (see example below)	https://www.samtec.com/products/sfsd
ISDF-05-D-M Connector Availability On-Line			
North-America (specific country can be selected)		http://www.newark.com/samtec/isdf-05-d-m/connector-housing-receptacle-10/dp/06R6184	
Europe (specific country can be selected)		http://uk.farnell.com/samtec/isdf-05-d-m/receptacle-1-27mm-crimp-10way/dp/2308547?ost=ISDF-05-D-M	
Asia-Pacific (specific country can be selected)		http://sg.element14.com/samtec/isdf-05-d-m/receptacle-1-27mm-crimp-10way/dp/2308547?ost=ISDF-05-D-M	
Important: Samtec ISDF-05-D-S is not compatible with Genie Nano			

Samtec ISDF-05-D-M mating connector for customer built cables w/retention clips “.050” Tiger Eye™ Discrete Wire Socket Housing”

ISDF-05-D-M

Description	Value
Series	ISDF
No. of Positions	-05
Row	-D - Double Row
End Options	-M - Metal Retention L
Part Number	ISDF-05-D-M

3D Preview
2D View
Download
Help



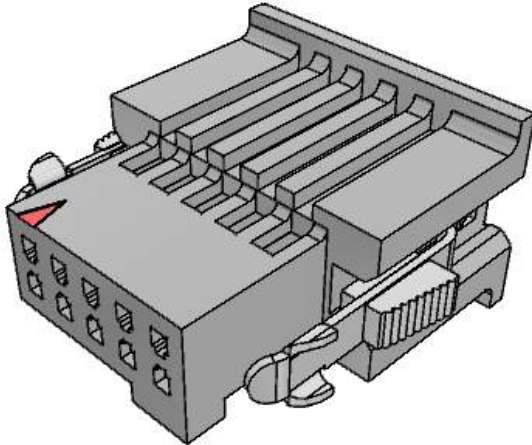

**Samtec connector-cable assembly SFSD-05-28-H-03.00-SR w/retention clips
 “.050” Tiger Eye™ Double Row Discrete Wire Cable Assembly, Socket”**

Description	Value
Series	SFSD
No. of Positions	-05
Wire Gauge	-28 AWG
Wire Color Code	All Black Wire
Plating Options	-H - 30µ" Heavy Gold
Assembly Length	3.00 INCH
End Option	-SR - Single Ended wit
Notch Option	Not Available
Part Number	SFSD-05-28-H-03.00-SR
Cable Type Option	PVC Cable

3D Preview
2D View
Download
Help

Power over Ethernet (PoE) Support

- The Genie Nano requires a PoE Class 0 or Class 2 (or greater) power source for the network if not using a separate external power source connected to pins 1 & 2 of the camera’s I/O Connector.
- To use PoE, the camera network setup requires a powered computer NIC supporting PoE, or a PoE capable Ethernet switch, or an Ethernet power injector.
- **Important:** Connect power via the I/O connector or PoE, but not both. Although Nano has protection, differences in ground levels may cause operational issues or electrical faults.
- If both supplies are connected and active, the Nano will use the I/O power supply connector. But as stated, ground differences may cause camera faults or failure.
- **Important:** When using PoE, the camera’s I/O pin 1 (Camera Power – Ground) must not be connected to I/O pin 3 (General Input Common Ground).

Input Signals Electrical Specifications

External Inputs Block Diagram

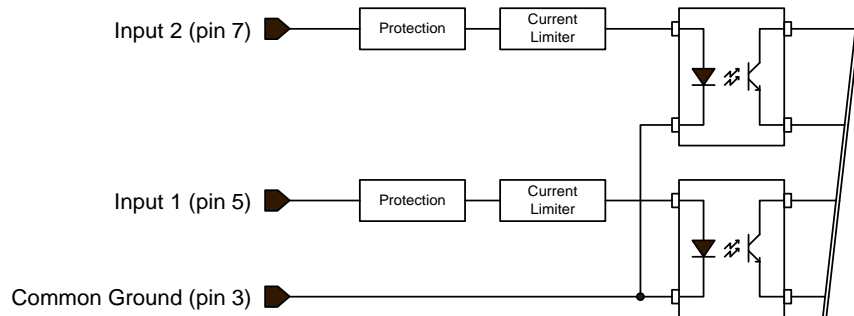

External Input Details

- Opto-coupled with internal current limit.
- Single input trigger threshold level (TTL standard: $<0.8V$ =Logical LOW, $>2.4V$ =Logical HIGH. See [lineDetectionLevel](#) feature).
- Used as trigger acquisition event, counter or timestamp event, or integration control.
- User programmable debounce time from 0 to 255 μ s in 1 μ s steps.
- Source signal requirements:
 - Single-ended driver meeting TTL, 12V, or 24V standards (see table below)
 - If using a differential signal driver, only one input can be used due to the shared input common (see details below)

External Input DC Characteristics

Operating Specification	Minimum	Maximum
Input Voltage	+3 V	+36 V
Input Current	7 mA	10.1 mA
Input logic Low		0.8 V
Input logic High	2.4 V	

Absolute Maximum Range before Possible Device Failure

Absolute Ratings	Minimum	Maximum
Input Voltage	-36 Volts	+36 Volts

External Input AC Timing Characteristics

Conditions	Description	Min	Unit
Input Pulse 0V – 3V	Input Pulse width High	1.3	μs
	Input Pulse width Low	1.7	μs
	Max Frequency	315	KHz
Input Pulse 0V – 5V	Input Pulse width High	0.6	μs
	Input Pulse width Low	2	μs
	Max Frequency	247	KHz
Input Pulse 0V -12V	Input Pulse width High	0.39	μs
	Input Pulse width Low	3	μs
	Max Frequency	160	KHz
Input Pulse 0V – 24V	Input Pulse width High	0.39	μs
	Input Pulse width Low	4.9	μs
	Max Frequency	103	KHz

External Inputs: Using TTL/LVTTL Drivers

- External Input maximum current is limited by the Nano circuits to a maximum of 10mA.

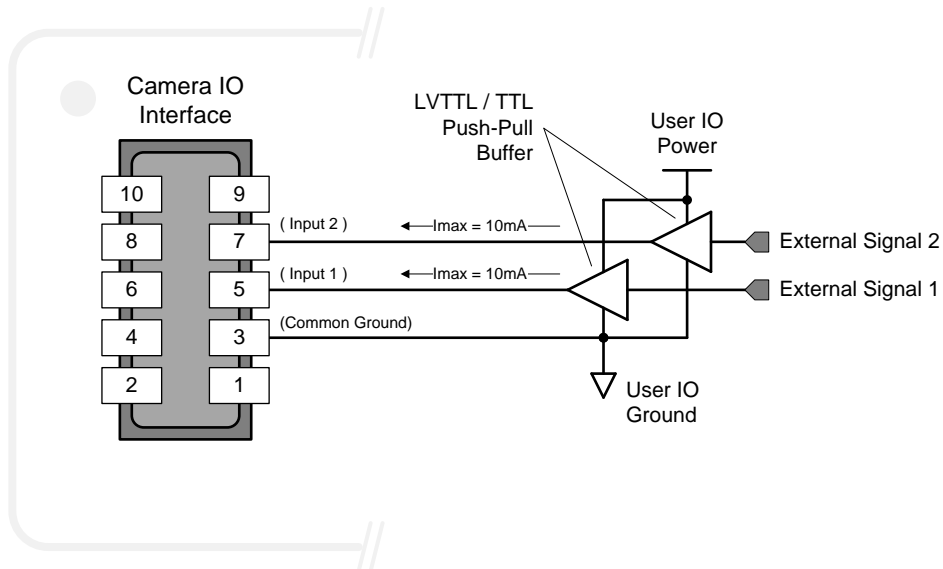

External Inputs: Using Common Collector NPN Drivers

- External Input maximum current is limited by the Nano circuits to a maximum of 10mA.

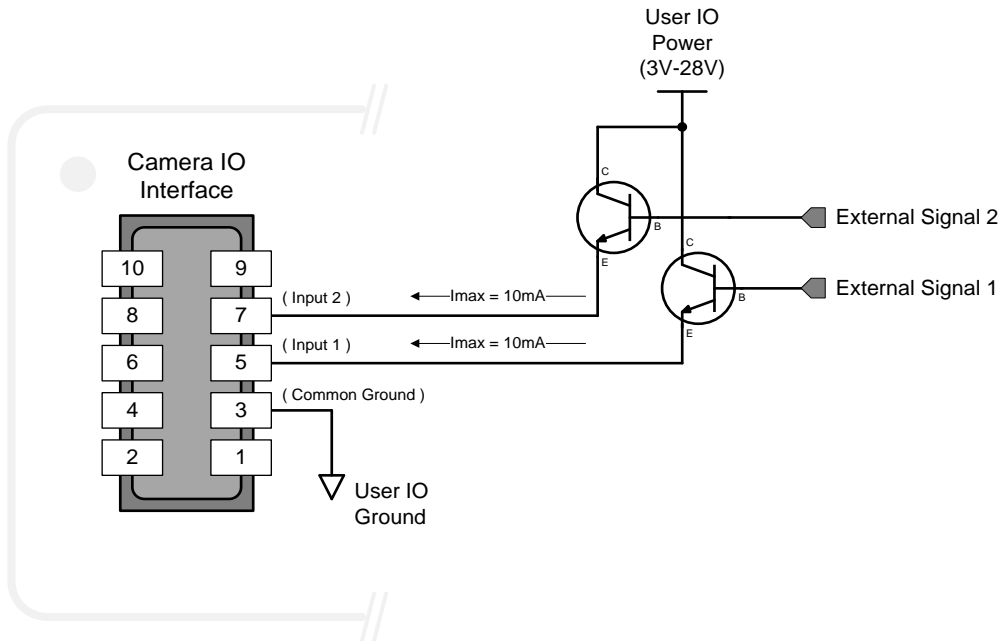

External Inputs: Using Common Emitter NPN Driver

- External Input maximum current is limited by the Nano circuits to a maximum of 10mA.
- Warning: Only one External Signal can be used (input 1 or input 2).

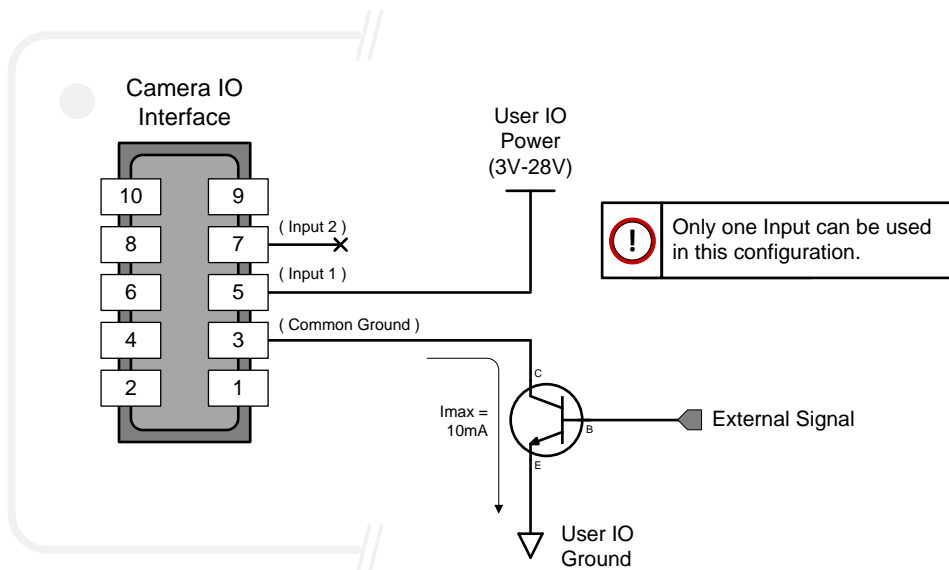

External Inputs: Using a Balanced Driver

- Warning: Only one External Signal can be used (input 1 or input 2).

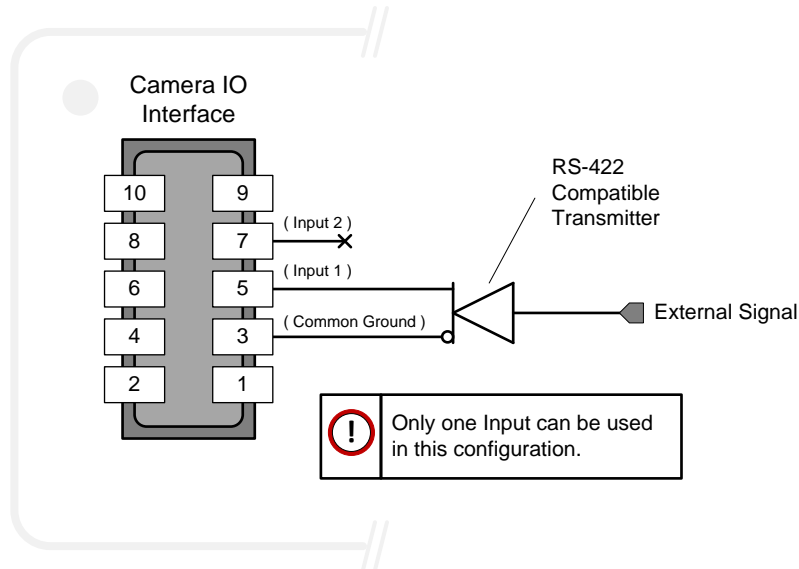

Output Signals Electrical Specifications

External Outputs Block Diagram

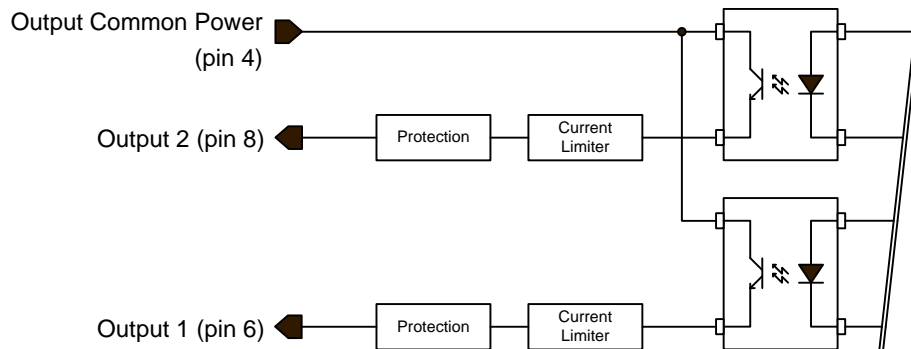

External Output Details and DC Characteristics

- Programmable output mode such as strobe, event notification, etc (see [outputLineSource](#) feature)
- Outputs are open on power-up with the default factory settings
- A software reset will not reset the outputs to the open state if the outputs are closed
- A user setup configured to load on boot will not reset the outputs to the open state if the outputs are closed
- No output signal glitch on power-up or polarity reversal
- **Typical** Operating Common Power Voltage Range: +3V to 28Vdc at 24mA
- **Maximum** Common Power Voltage Range : ±30Vdc
- **Maximum** Output Current: 36mA

External Output AC Timing Characteristics

The graphic below defines the test conditions used to measure the Nano external output AC characteristics, as detailed in the table that follows.

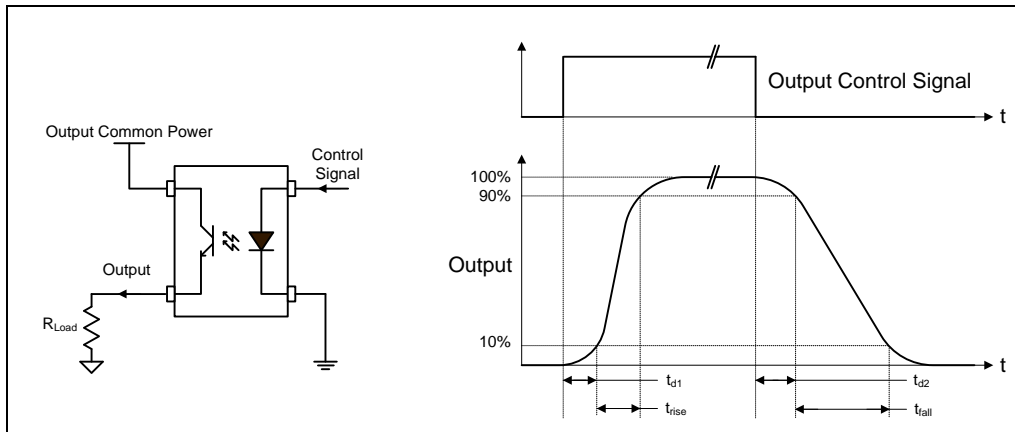

Opto-coupled Output: AC Characteristics at an internal FPGA temperature of 83C

Note: All measurements subject to some rounding.

Output Common Power	Output Current	R _{load} Test	t _{d1} (μs) Leading Delay	t _{rise} (μs) Rise Time	t _{d2} (μs) Trailing Delay	t _{fall} (μs) Fall Time
3V	8 mA	250 ohm	0.47	2.9	11.4	26.6
	16 mA	124 ohm	0.47	4.7	4.3	19.5
5V	8 mA	514 ohm	4.66	2.6	13.3	25.3
	16 mA	236 ohm	0.5	7.0	4.4	17.9
	21 mA	73 ohm	0.45	4.4	3.1	10.7
12V	8 mA	1.4K ohm	0.62	2.0	18.1	24.9
	16 mA	677 ohm	0.54	4.8	7.5	19.9
	24 mA	316 ohm	0.5	3.5	3.8	11.5
24V	8 mA	2.88K ohm	0.62	2.1	18.9	39.9
	16 mA	1.42K ohm	0.63	4.7	10.9	27.1
	24 mA	810 ohm	0.79	4.9	5.2	17.4

AC characteristics for optional models denoted by "G3-GM2..." or G3-GC2..." part numbers is found in addendum – [AC Characteristics of 1 Input / 3 Output Models](#).

External Outputs: Using External TTL/LVTTL Drivers

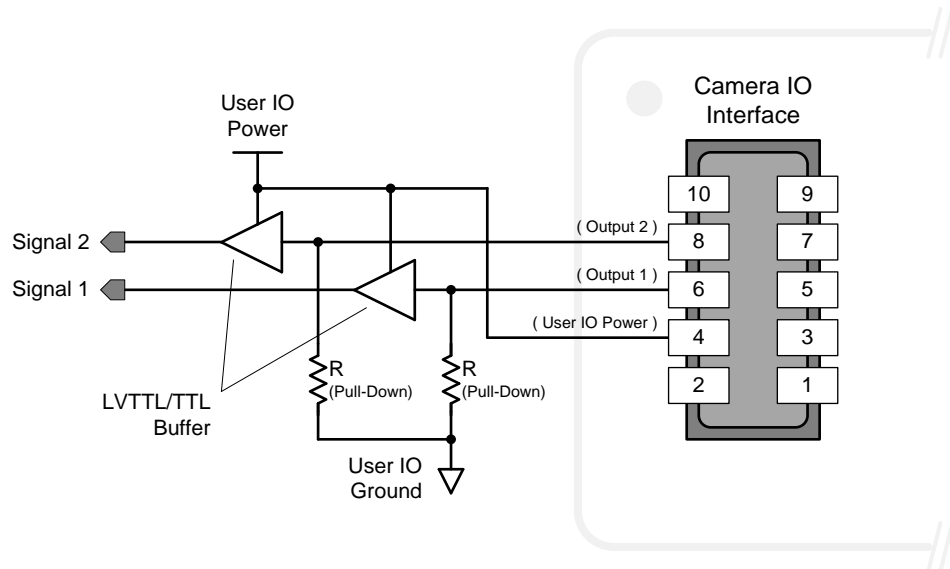

External Outputs: Using External LED Indicators

- Two external LEDs can be connected in the Common Cathode configuration.

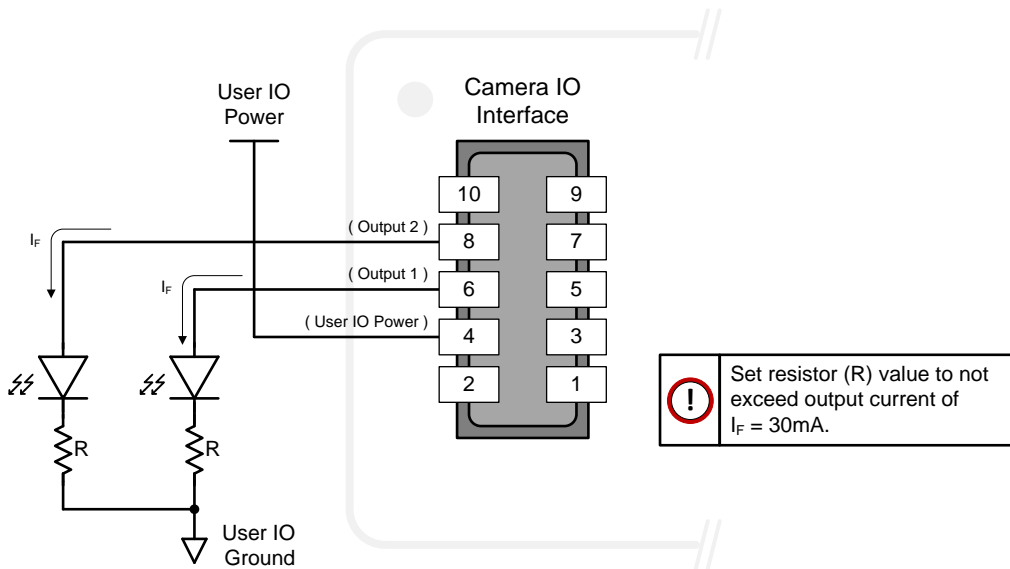

- Alternatively one external LED can be connected in the Common Anode configuration.

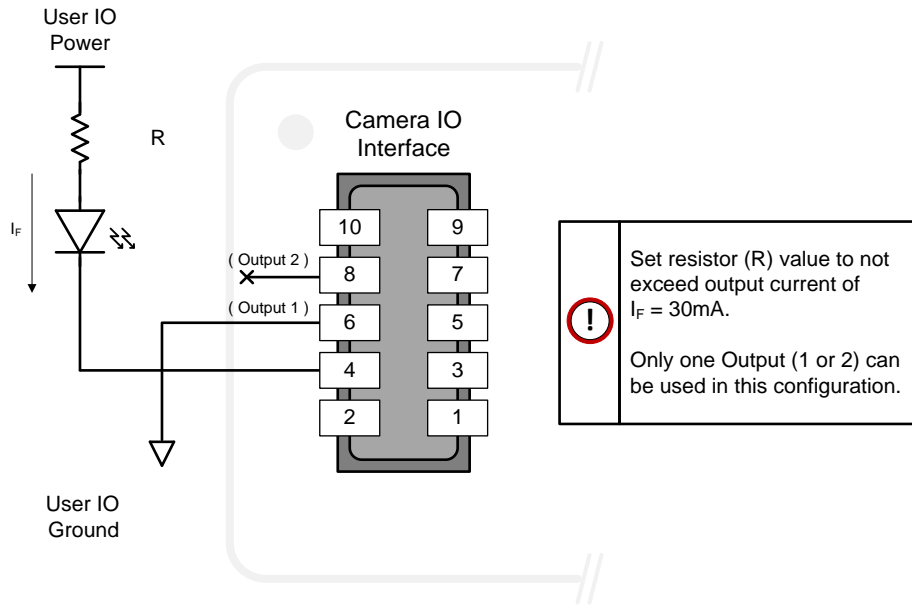

Using Nano Outputs to drive other Nano Inputs

- A synchronization method where one Nano camera signals other Nano cameras.
- Note: One Nano output can drive a maximum of three slave cameras per GPIO line.

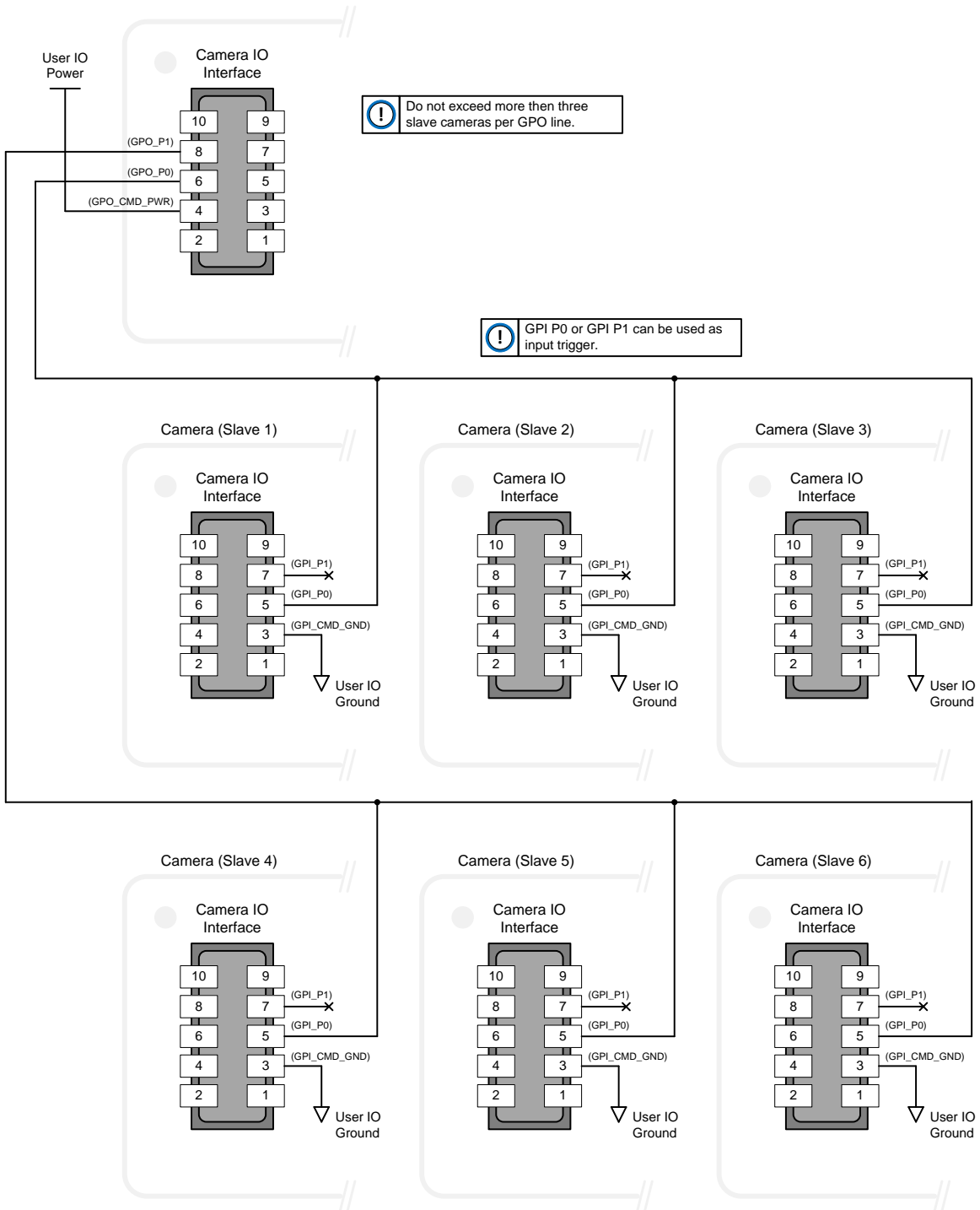

Computer Requirements for Nano Cameras

The following information is a guide to computer and networking equipment required to support the Nano camera at maximum performance. The Nano camera series complies with the current Ipv4 Internet Protocol, therefore current Gigabit Ethernet (GigE) equipment should provide trouble free performance.

Host PC System

- Refer to your GigE-Vision compliant SDK for computer requirements.

Recommended Network Adapters

- GigE network adapter (either add on card or on motherboard). The Intel PRO/1000 MT adapter is an example of a high performance NIC. Typically a system will need an Ethernet GigE adapter to supplement the single NIC on the motherboard.
- PCI Express adapters will outperform PCI adapters.
- Network adapters that support Jumbo Frames will minimize CPU utilization.
- **Important:** 10/100 Mb Ethernet is not supported by the Genie Nano series of cameras. The Genie Nano Status LED will show that it acquired an IP address (solid Blue) but the Nano will not respond or function at these slower connections.

Ethernet Switch Requirements

When there is more than one device on the same network or a camera-to-PC separation greater than 100 meters, an Ethernet (Gigabit) switch is required. Since the Genie Nano GigE camera complies with the Internet Protocol, it should work with all standard Ethernet switches. However, switches offer a range of functions and performance grades, so care must be taken to choose the right switch for a particular application.

Note that in multi-camera setups using a Gigabit Ethernet switch, the Device Link Throughput may need to be reduced so that each camera can equally share the available bandwidth. This feature can be verified via CamExpert using the [GigE Vision Transport Layer Control](#).

IEEE 802.3x Pause Frame Flow Control

Ethernet Switches supporting Full-duplex IEEE 802.3x Pause Frame Flow Control must be used in situations where multiple cameras may be triggered simultaneously. In such a case the NIC maximum bandwidth would be exceeded if there was no mechanism to temporarily hold back data from cameras. Nano cameras support the IEEE 802.3x pause frame flow control protocol automatically so that images from many cameras can be transmitted through the switch to the NIC efficiently, without data loss. As a working example, one such switch tested at Teledyne DALSA is the NETGEAR GS716T.



Important: The maximum frame rate possible from a large number of Nano cameras which are simultaneously triggered will depend on the Nano model, frame size, and network details.

Note: Some Ethernet Switches may produce more Pause Frame requests than expected when Jumbo Frames is enabled. Setting the Ethernet Packet Size to the default of 1500, may minimize Pause Requests from such a switch and improve overall transfer bandwidth.

Ethernet to Fiber-Optic Interface Requirements

In cases of camera-to-PC separations of more than 100 meters but an Ethernet switch is not desired, a fiber-optic media converter can be used. The FlexPoint GX from Omnitron Systems (www.omnitron-systems.com) converts GigE to fiber transmission and vice versa. It supports multimode (MM) fiber over distances of up to 220 m (720 ft.) and single-mode (SM) fiber up to 65 km (40 mi.) with SC, MT-RJ, or LC connector types.

Important: The inclusion in this manual of GigE to fiber-optic converters does not guarantee they will meet specific application requirements or performance. The user must evaluate any supplemental Ethernet equipment.

EC & FCC Declarations of Conformity

Models: M/C1920, M/C1940



EC & FCC DECLARATION OF CONFORMITY

We :
Teledyne DALSA inc.
880 Rue McCaffrey
St -Laurent, Québec
Canada H4T 2C7

Declare under sole legal responsibility that the following products conform to the protection requirements of council directive 2004/108/EC (2014/30/EU after April 2016) on the approximation of the laws of member states relating to electromagnetic compatibility and are CE-marked accordingly:

Genie Nano M1920/C1920/M1940/C1940

The products to which this declaration relates are in conformity with the following relevant harmonized standards, the reference numbers of which have been published in the Official Journal of the European Communities:

EN55032 (2012)	Electromagnetic compatibility of multimedia equipment — Emission requirements
EN55011 (2009) with A1(2010)	Industrial, scientific and medical equipment — Radio-frequency disturbance characteristics — Limits and methods of measurement
EN 61326-1 (2013)	Electrical equipment for measurement, control and laboratory use — EMC requirements — Part 1: General requirements
EN 55024 (2010)	Information technology equipment — Immunity characteristics — Limits and methods of measurement

Further declare under our sole legal responsibility that the product listed also conforms to the following international standards:

CFR 47	part 15 (2008), subpart B, for a class A product. Limits for digital devices
ICES-003	Information Technology Equipment (ITE) — Limits and Methods of Measurement
CISPR 11	Industrial, scientific and medical equipment - Radio-frequency disturbance characteristics - Limits and methods of measurement
CISPR 32	Electromagnetic compatibility of multimedia equipment - Emission requirements

Note: this product is intended to be a component of a larger system.

Waterloo, Canada
Location

2015-09-22
Date



Hank Helmond.
Director, Quality Assurance

THIS IS AN UNCONTROLLED COPY OF A CONTROLLED DOCUMENT PRINTED 2/19/2015 11:33 AM
The information contained herein is proprietary to TELEDYNE DALSA and is to be used solely for the purpose for which it is supplied. It shall not be disclosed in whole or in part, to any other party, without the express permission in writing by TELEDYNE DALSA.

Models: M/C2590, M/C1930, M/C1280, M/C800, M/C640



EC & FCC DECLARATION OF CONFORMITY

We :
 Teledyne DALSA inc.
 880 Rue McCaffrey
 St -Laurent, Québec
 Canada H4T 2C7

Declare under sole legal responsibility that the following products conform to the protection requirements of council directive 2004/108/EC (2014/30/EU after April 2016) on the approximation of the laws of member states relating to electromagnetic compatibility and are CE-marked accordingly:

Genie Nano
M0640/M0800/M1280/M1930/M2590
C0640/C0800/C1280/C1930/C2590

The products to which this declaration relates are in conformity with the following relevant harmonized standards, the reference numbers of which have been published in the Official Journal of the European Communities:

EN55032 (2012)	Electromagnetic compatibility of multimedia equipment — Emission requirements
EN55011 (2009) with A1(2010)	Industrial, scientific and medical equipment — Radio-frequency disturbance characteristics — Limits and methods of measurement
EN 61326-1 (2013)	Electrical equipment for measurement, control and laboratory use — EMC requirements — Part 1: General requirements
EN 55024 (2010)	Information technology equipment — Immunity characteristics — Limits and methods of measurement

Further declare under our sole legal responsibility that the product listed also conforms to the following international standards:

CFR 47	part 15 (2008), subpart B, for a class A product. Limits for digital devices
ICES-003	Information Technology Equipment (ITE) — Limits and Methods of Measurement
CISPR 11	Industrial, scientific and medical equipment - Radio-frequency disturbance characteristics - Limits and methods of measurement
CISPR 32	Electromagnetic compatibility of multimedia equipment - Emission requirements

Note: this product is intended to be a component of a larger system.

Waterloo, Canada 2016-01-29
 Location Date

Hank Helmond.
 Director, Quality Assurance

THIS IS AN UNCONTROLLED COPY OF A CONTROLLED DOCUMENT PRINTED 1/15/2016 11:33 AM
 The information contained herein is proprietary to TELEDYNE DALSA and is to be used solely for the purpose for which it is supplied. It shall not be disclosed in whole or in part, to any other party, without the express permission in writing by TELEDYNE DALSA.

Models: M/C2020, M/C2050, M/C2420, M/C2450



EC & FCC DECLARATION OF CONFORMITY

We :
 Teledyne DALSA inc.
 880 Rue McCaffrey
 St -Laurent, Québec
 Canada H4T 2C7

Declare under sole legal responsibility that the following products conform to the protection requirements of council directive 2004/108/EC (2014/30/EU after April 2016) on the approximation of the laws of member states relating to electromagnetic compatibility and are CE-marked accordingly:

Genie Nano M2020, M2050, M2420, M2450
Genie Nano C2020, C2050, C2420, C2450

The products to which this declaration relates are in conformity with the following relevant harmonized standards, the reference numbers of which have been published in the Official Journal of the European Communities:

EN55032 (2012)	Electromagnetic compatibility of multimedia equipment — Emission requirements
EN55011 (2009) with A1(2010)	Industrial, scientific and medical equipment — Radio-frequency disturbance characteristics — Limits and methods of measurement
EN 61326-1 (2013)	Electrical equipment for measurement, control and laboratory use — EMC requirements — Part 1: General requirements
EN 55024 (2010)	Information technology equipment — Immunity characteristics — Limits and methods of measurement

Further declare under our sole legal responsibility that the product listed also conforms to the following international standards:

CFR 47	part 15 (2008), subpart B, for a class A product. Limits for digital devices
ICES-003	Information Technology Equipment (ITE) — Limits and Methods of Measurement
CISPR 11	Industrial, scientific and medical equipment - Radio-frequency disturbance characteristics - Limits and methods of measurement
CISPR 32	Electromagnetic compatibility of multimedia equipment - Emission requirements

Note: this product is intended to be a component of a larger system.

Waterloo, Canada
 Location

2016-05-11
 Date



 Hank Helmond,
 Director, Quality Assurance

THIS IS AN UNCONTROLLED COPY OF A CONTROLLED DOCUMENT PRINTED 2/19/2015 11:33 AM
 The information contained herein is proprietary to TELEDYNE DALSA and is to be used solely for the purpose for which it is supplied. It shall not be disclosed in whole or in part, to any other party, without the express permission in writing by TELEDYNE DALSA.

Models: M/C4020, M/C4030, M/C4040, M/C4060



EC & FCC DECLARATION OF CONFORMITY

We :
 Teledyne DALSA inc.
 880 Rue McCaffrey
 St -Laurent, Québec
 Canada H4T 2C7

Declare under sole legal responsibility that the following products conform to the protection requirements of council directive 2004/108/EC (2014/30/EU after April 2016) on the approximation of the laws of member states relating to electromagnetic compatibility and are CE-marked accordingly:

Genie Nano M4020, M4040, M4030, M4060
Genie Nano C4020, C4040, C4030, C4060

The products to which this declaration relates are in conformity with the following relevant harmonized standards, the reference numbers of which have been published in the Official Journal of the European Communities:

EN55032 (2012)	Electromagnetic compatibility of multimedia equipment — Emission requirements
EN55011 (2009) with A1(2010)	Industrial, scientific and medical equipment — Radio-frequency disturbance characteristics — Limits and methods of measurement
EN 61326-1 (2013)	Electrical equipment for measurement, control and laboratory use — EMC requirements — Part 1: General requirements
EN 55024 (2010)	Information technology equipment — Immunity characteristics — Limits and methods of measurement

Further declare under our sole legal responsibility that the product listed also conforms to the following international standards:

CFR 47	part 15 (2008), subpart B, for a class A product. Limits for digital devices
ICES-003	Information Technology Equipment (ITE) — Limits and Methods of Measurement
CISPR 11	Industrial, scientific and medical equipment - Radio-frequency disturbance characteristics - Limits and methods of measurement
CISPR 32	Electromagnetic compatibility of multimedia equipment - Emission requirements

Note: this product is intended to be a component of a larger system.

Waterloo, Canada
 Location

2017-01-23
 Date



 Hank Helmond,
 Director, Quality Assurance

THIS IS AN UNCONTROLLED COPY OF A CONTROLLED DOCUMENT PRINTED 1/23/2017 11:33 AM
 The information contained herein is proprietary to TELEDYNE DALSA and is to be used solely for the purpose for which it is supplied. It shall not be disclosed in whole or in part, to any other party, without the express permission in writing by TELEDYNE DALSA.

Models: M/C5100, M/C4090



EC & FCC DECLARATION OF CONFORMITY

We :
 Teledyne DALSA inc.
 880 Rue McCaffrey
 St -Laurent, Québec
 Canada H4T 2C7

Declare under sole legal responsibility that the following products conform to the protection requirements of council directive 2004/108/EC (2014/30/EU after April 2016) on the approximation of the laws of member states relating to electromagnetic compatibility and are CE-marked accordingly:

Genie Nano M4090, M5100
Genie Nano C4090, C5100

The products to which this declaration relates are in conformity with the following relevant harmonized standards, the reference numbers of which have been published in the Official Journal of the European Communities:

EN55032 (2012)	Electromagnetic compatibility of multimedia equipment — Emission requirements
EN55011 (2009) with A1(2010)	Industrial, scientific and medical equipment — Radio-frequency disturbance characteristics — Limits and methods of measurement
EN 61326-1 (2013)	Electrical equipment for measurement, control and laboratory use — EMC requirements — Part 1: General requirements
EN 55024 (2010)	Information technology equipment — Immunity characteristics — Limits and methods of measurement

Further declare under our sole legal responsibility that the product listed also conforms to the following international standards:

CFR 47	part 15 (2008), subpart B, for a class A product. Limits for digital devices
ICES-003	Information Technology Equipment (ITE) — Limits and Methods of Measurement
CISPR 11	Industrial, scientific and medical equipment - Radio-frequency disturbance characteristics - Limits and methods of measurement
CISPR 32	Electromagnetic compatibility of multimedia equipment - Emission requirements

Note: this product is intended to be a component of a larger system.

Waterloo, Canada
 Location

2017-01-23
 Date



 Hank Helmond,
 Director, Quality Assurance

THIS IS AN UNCONTROLLED COPY OF A CONTROLLED DOCUMENT PRINTED 1/23/2017 11:33 AM
 The information contained herein is proprietary to TELEDYNE DALSA and is to be used solely for the purpose for which it is supplied. It shall not be disclosed in whole or in part, to any other party, without the express permission in writing by TELEDYNE DALSA.

Additional Reference Information

Choosing a Lens with the Correct Image Circle

Each Nano model requires a lens with an image circle specification to fully illuminate the sensor. The following section graphically shows the minimum lens image circle for each Nano model family along with alternative lens types. Brief information on other lens parameters to consider follows those sections.

Lens Options for Models 'M/C1940' & 'M/C1920'

- The following figure shows the lens image circles relative to Genie Nano models using the Sony IMX174 and IMX249 sensors respectively.
- A typical 1" lens will fully illuminate these sensors while the use of a 2/3" lens will have some corner vignetting.
- Note the "horizontal blue dashed lines" defining the HD video format. These indicate setting the Image Format controls to Height=1080 with a Vertical Offset=60.

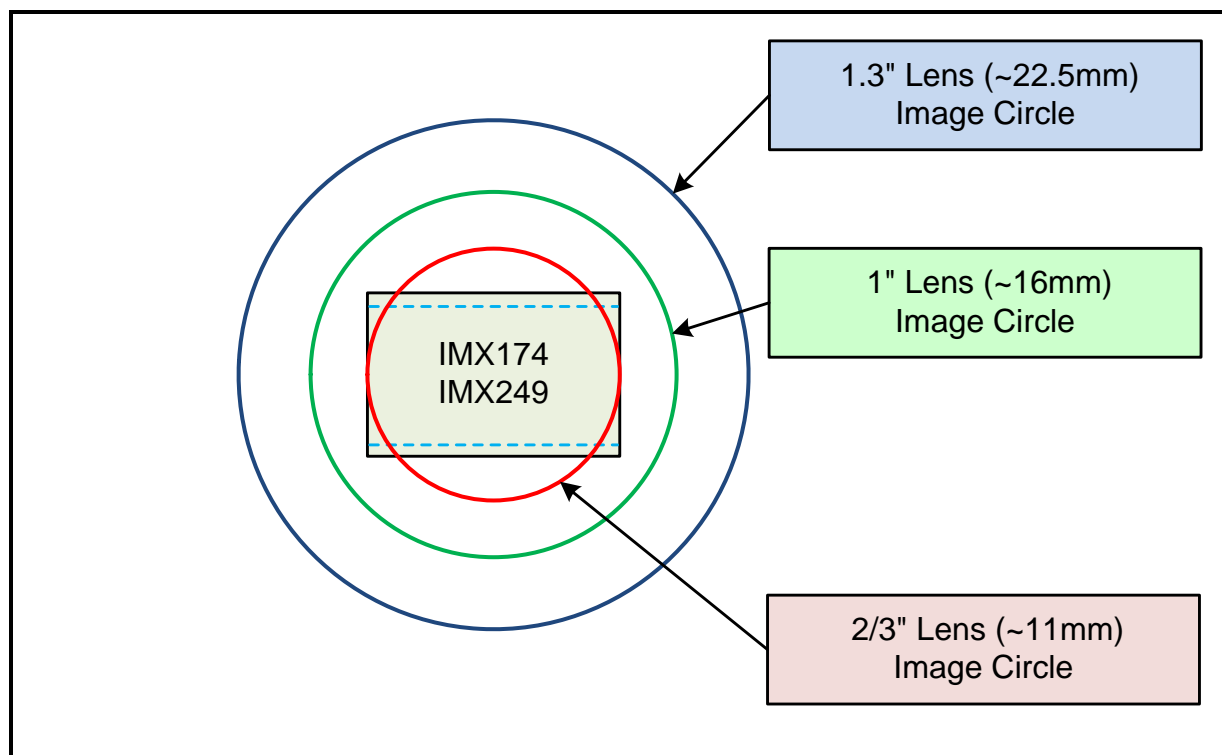

Lens Options for Models '2450/2420' & '2050/2020'

- The following figure shows the lens image circles relative to Genie Nano models using the Sony IMX250/264 and IMX252/265 sensors, in color or monochrome versions.
- A typical 2/3" lens will fully illuminate these sensors. A smaller 1/1.8" lens could be used with Models 2050/2020.

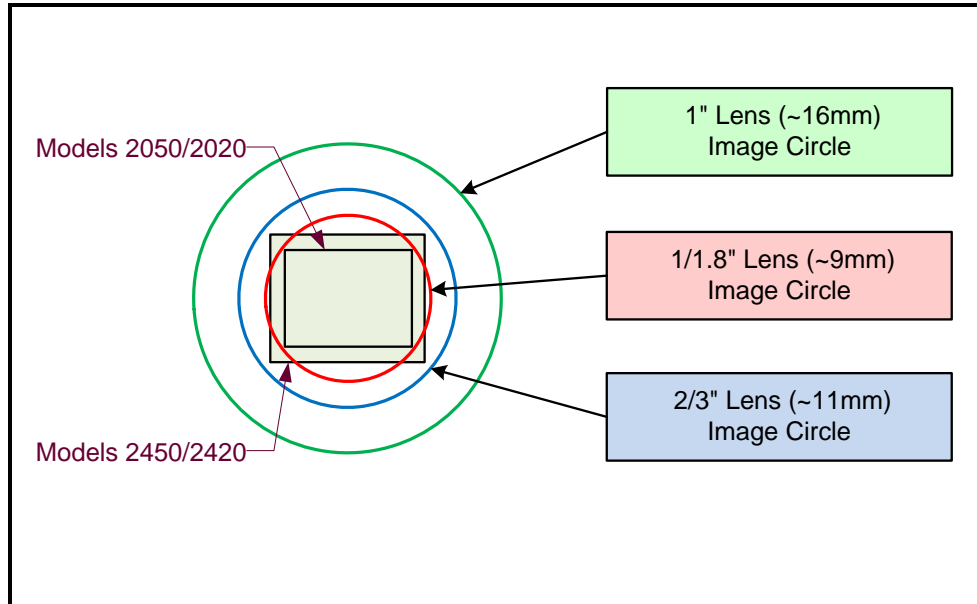

Lens Options for Models '4060/4040/4030/4020'

- The following figure shows the lens image circles relative to Genie Nano models using the Sony IMX255 (models 4060), IMX253 (models 4040), IMX267 (models 4030), and IMX304 (models 4020) sensors.
- A typical 1.1" lens will illuminate both sensors models while the 1" lens should only be used with models 4060 & 4030 to avoid image vignetting.

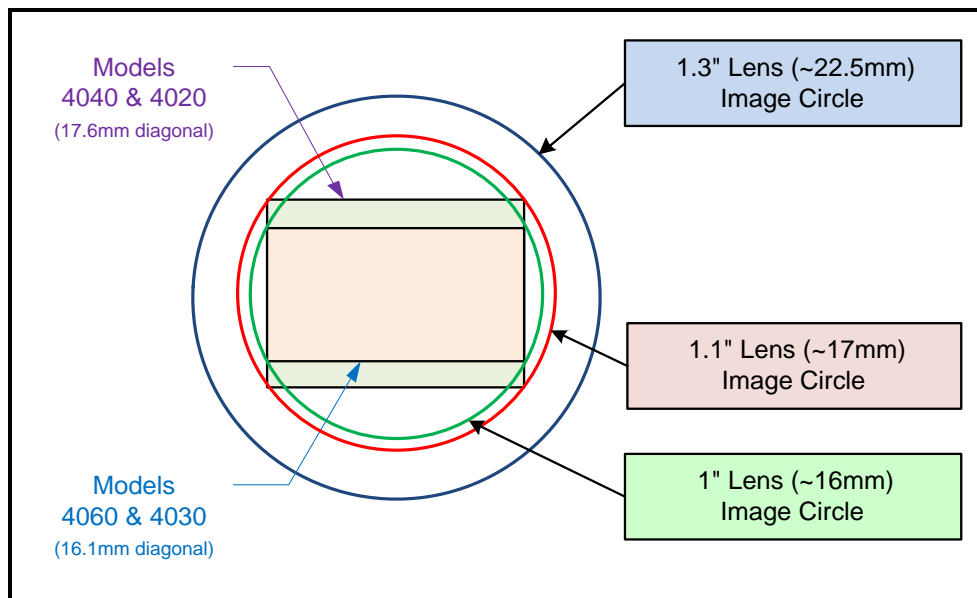

Lens Options for Models 'M/C1450'

- The following figure shows the lens image circles relative to Genie Nano models using the Sony IMX273 sensor.
- A typical 1/3" lens will almost fully illuminate this sensor with just a small amount of vignetting in the corners. A 1/2" lens exceeds the required image circle.

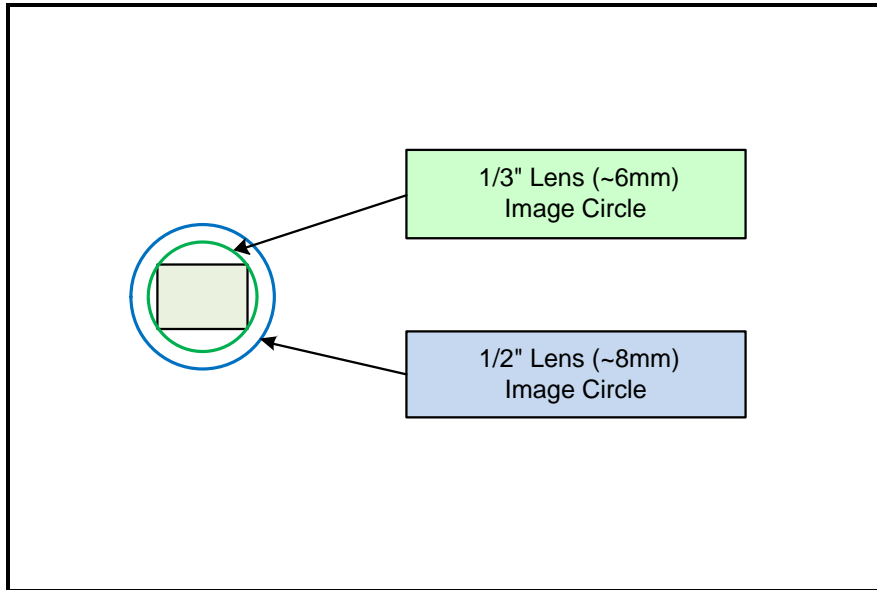

Lens Options for XL Models 'M/C 5100' and 'M/C 4090'

- The following figure shows the lens image circles relative to Genie NanoXL models using the OnSemi Python 25K and Python 16K sensors.
- These NanoXL models have a M42 screw mount where M42 lens or F-mount lens (via an adapter) need to have image circles exceeding the diameter of either of these larger sensors.

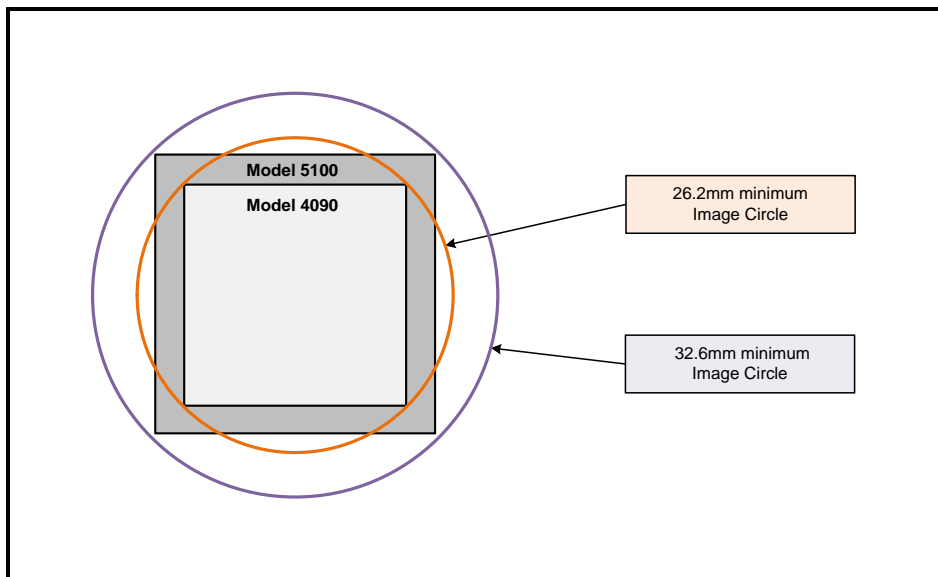

Lens Options for Model 'C4900'

- The following figure shows the lens image circles relative to Genie Nano model using the OnSemi AR1820HS sensor.

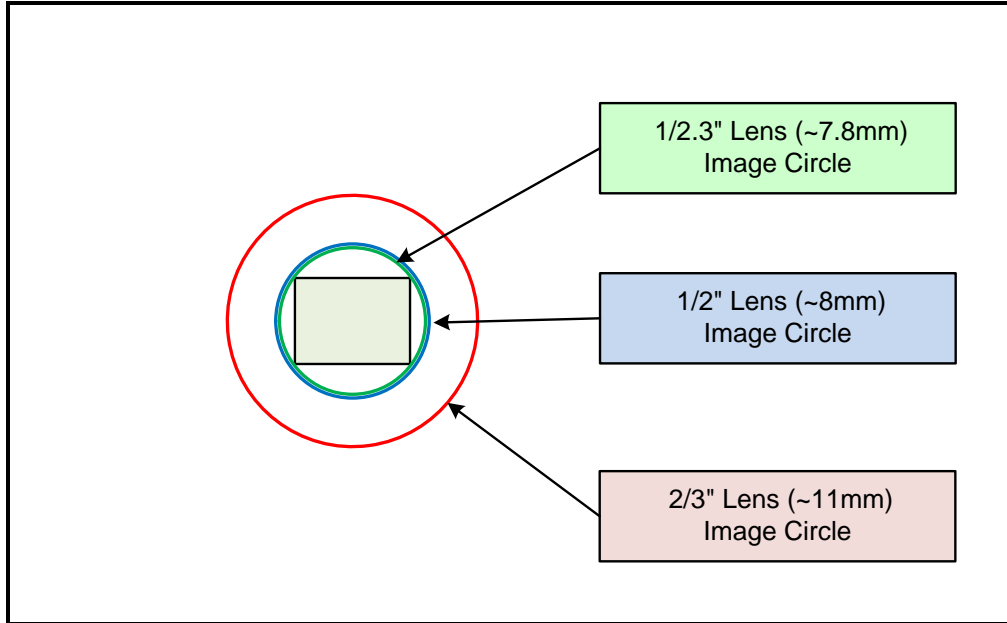

Lens Options for Models 'M/C2590' & 'M/C 2540'

- The following figure shows the lens image circles relative to Genie Nano models using the OnSemi Python5000 sensor.
- A typical 1" lens will fully illuminate these sensors.

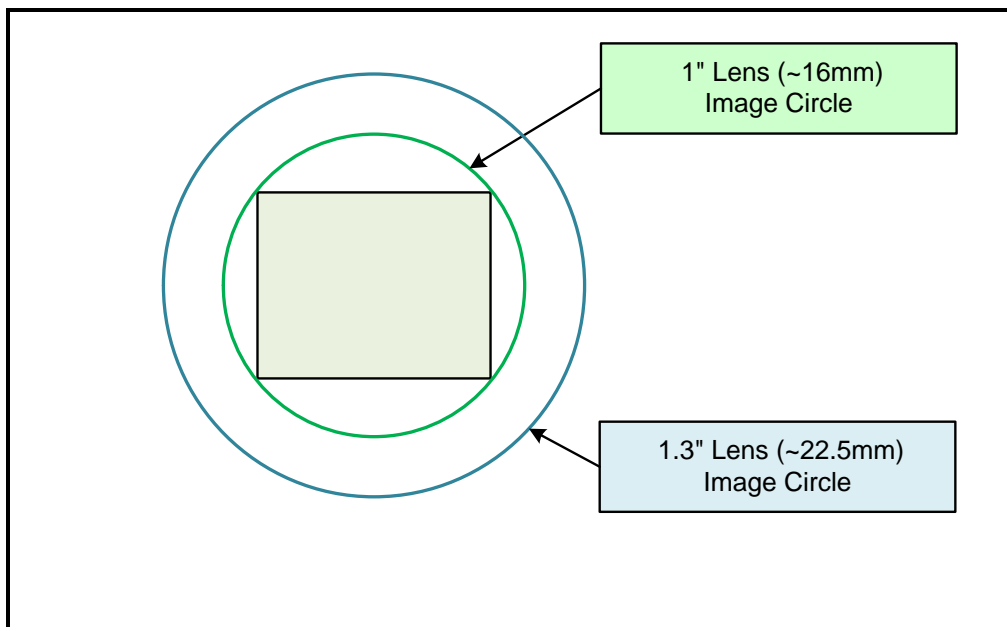

Lens Options for Models 'M/C1930'

- The following figure shows the lens image circles relative to Genie Nano models using the OnSemi Python2000 sensor.
- A typical 2/3" lens will fully illuminate these sensors.

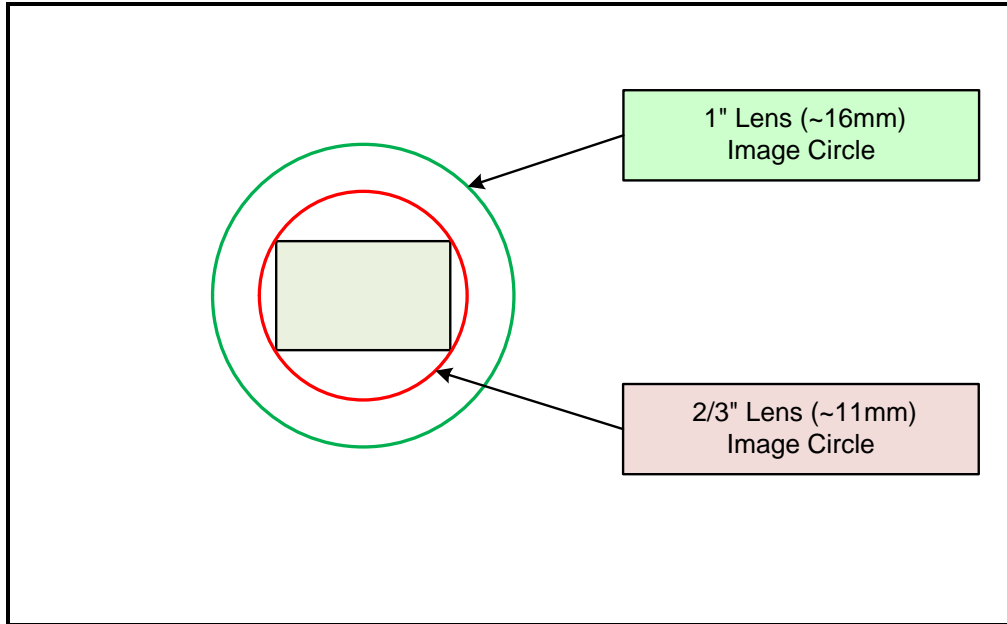

Lens Options for Models 'M/C1280' & 'M/C1240'

- The following figure shows the lens image circles relative to Genie Nano models using the OnSemi Python1300 sensor.
- A typical 1/2" lens will fully illuminate these sensors.

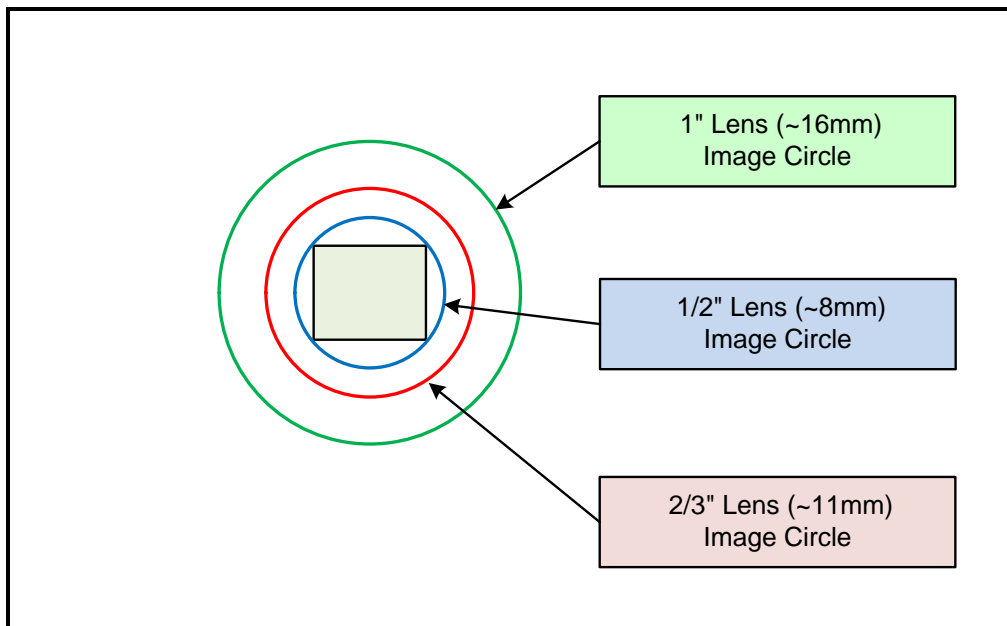

Lens Options for Models 'M/C800'

- The following figure shows the lens image circles relative to Genie Nano models using the OnSemi Python500 sensor.
- A typical 1/3" lens will fully illuminate these sensors.

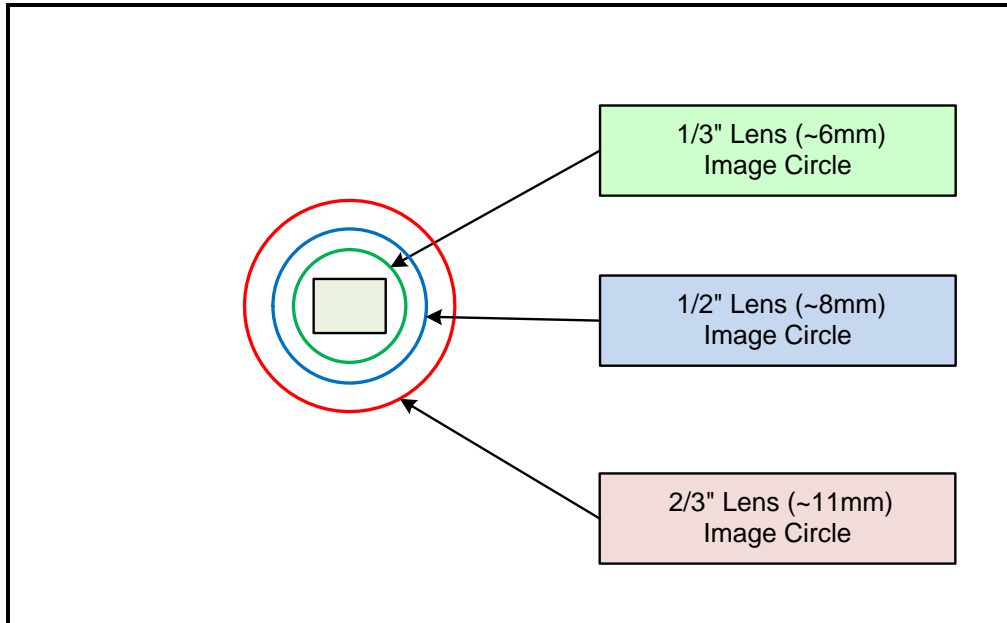

Lens Options for Models 'M/C700'

- The following figure shows the lens image circles relative to Genie Nano models using the Sony IMX287 sensor.
- A typical 1/2" lens will fully illuminate this sensor while a 1/3" lens would have some corner vignetting.

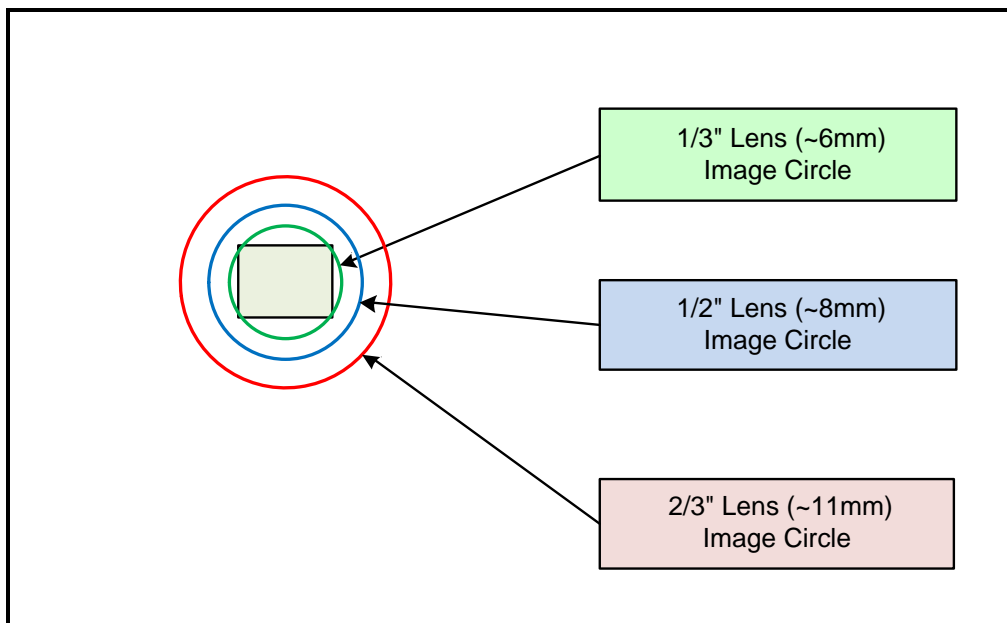

Lens Options for Models 'M/C640'

- The following figure shows the lens image circles relative to Genie Nano models using the OnSemi Python300 sensor.
- A typical ¼" lens will fully illuminate these sensors.

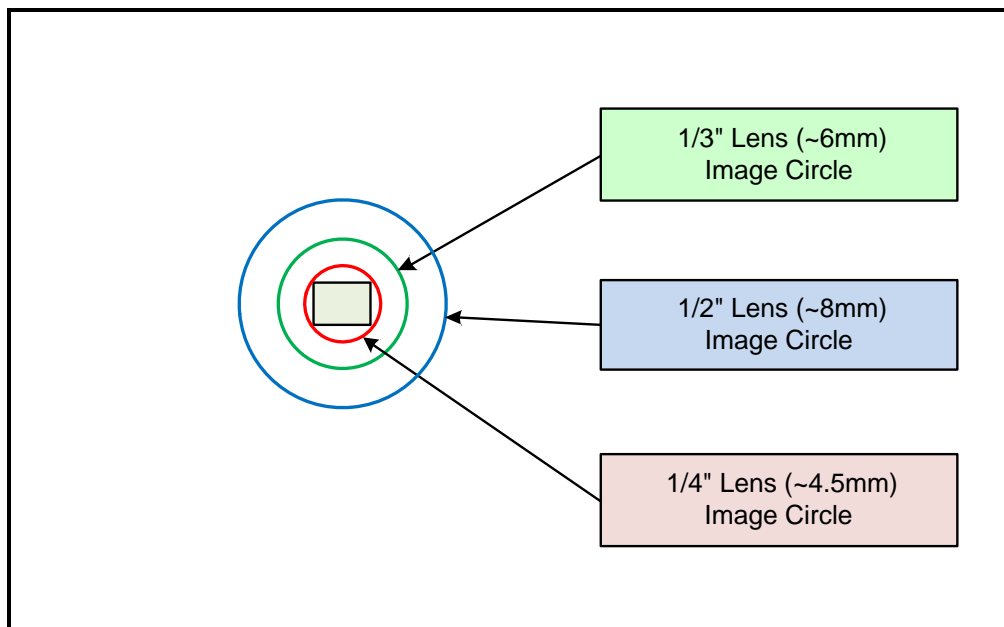

Additional Lens Parameters (application specific)

There are other lens parameters that are chosen to meet the needs of the vision application. These parameters are independent of the Nano model (assuming that the Lens Mount and Lens Sensor Size parameters are correct, as previously covered in this section). A vision system integrator or lens specialist should be consulted when choosing lenses since there is a trade-off between the best lenses and cost. An abridged list of lens parameters follows – all of which need to be matched to the application.

- **Focal Length:** Defines the focus point of light from infinity. This parameter is related to the Nano mount (C or CS mount). See Genie Nano Specifications — Back Focal Distance.
- **Field of View:** A lens is designed to image objects at some limited distance range, at some positive or negative magnification. This defines the field of view.
- **F-Number (aperture):** The lens aperture defines the amount of light that can pass. Lenses may have fixed or variable apertures. Additionally the lens aperture affects Depth of Field which defines the distance range which is in focus when the lens is focus at some specific distance.
- **Image Resolution and Distortion:** A general definition of image quality. A lens with poor resolution seems to never be in focus when used to image fine details.
- **Aberrations (defect, chromatic, spherical):** Aberrations are specific types of lens faults affecting resolution and distortion. Lens surface defects or glass faults distort all light or specific colors. Aberrations are typically more visible when imaging fine details.
- **Spatial Distortions:** Describes non-linear lens distortions across the field of view. Such distortion limits the accuracy of measurements made with that lens.

Optical Considerations

This section provides an overview to illumination, light sources, filters, lens modeling, and lens magnification. Each of these components contribute to the successful design of an imaging solution.

Illumination

The amount and wavelengths of light required to capture useful images depend on the particular application. Factors include the nature, speed, and spectral characteristics of objects being imaged, exposure times, light source characteristics, environmental and acquisition system specifics, and more. The Teledyne DALSA Web site, <http://mv.dalsa.com/>, provides an introduction to this potentially complicated issue. Click on Knowledge Center and then select Application Notes and Technology Primers. Review the sections of interest.

It is often more important to consider exposure than illumination. The total amount of energy (which is related to the total number of photons reaching the sensor) is more important than the rate at which it arrives. For example, $5\mu\text{J}/\text{cm}^2$ can be achieved by exposing $5\text{mW}/\text{cm}^2$ for 1ms just the same as exposing an intensity of $5\text{W}/\text{cm}^2$ for $1\mu\text{s}$.

Light Sources

Keep these guidelines in mind when selecting and setting up light source:

- LED light sources are relatively inexpensive, provide a uniform field, and longer life span compared to other light sources. However, they also require a camera with excellent sensitivity.
- Halogen light sources generally provide very little blue relative to infrared light (IR).
- Fiber-optic light distribution systems generally transmit very little blue relative to IR.
- Some light sources age such that over their life span they produce less light. This aging may not be uniform—a light source may produce progressively less light in some areas of the spectrum but not others.

IR Cut-off Filters

Genie Nano cameras are responsive to near infrared (IR) wavelengths. To prevent infrared from distorting the color balance of visible light acquisitions, use a “hot mirror” or IR cut-off filter that transmits visible wavelengths but does not transmit near infrared wavelengths and above.

Genie Nano color cameras have a spectral response that extends into near IR wavelengths (as defined for each sensor model in the sensor specification descriptions). Images captured will have washed out color if the sensor response is not limited to the visible light band.

Nano Models with Built-in IR Cut-off Filters

Choose Nano color cameras with built-in IR Cut-off Filters for an optimized solution. The following graphic shows these models having an IR filter with a specified cut-off of about 646nm.

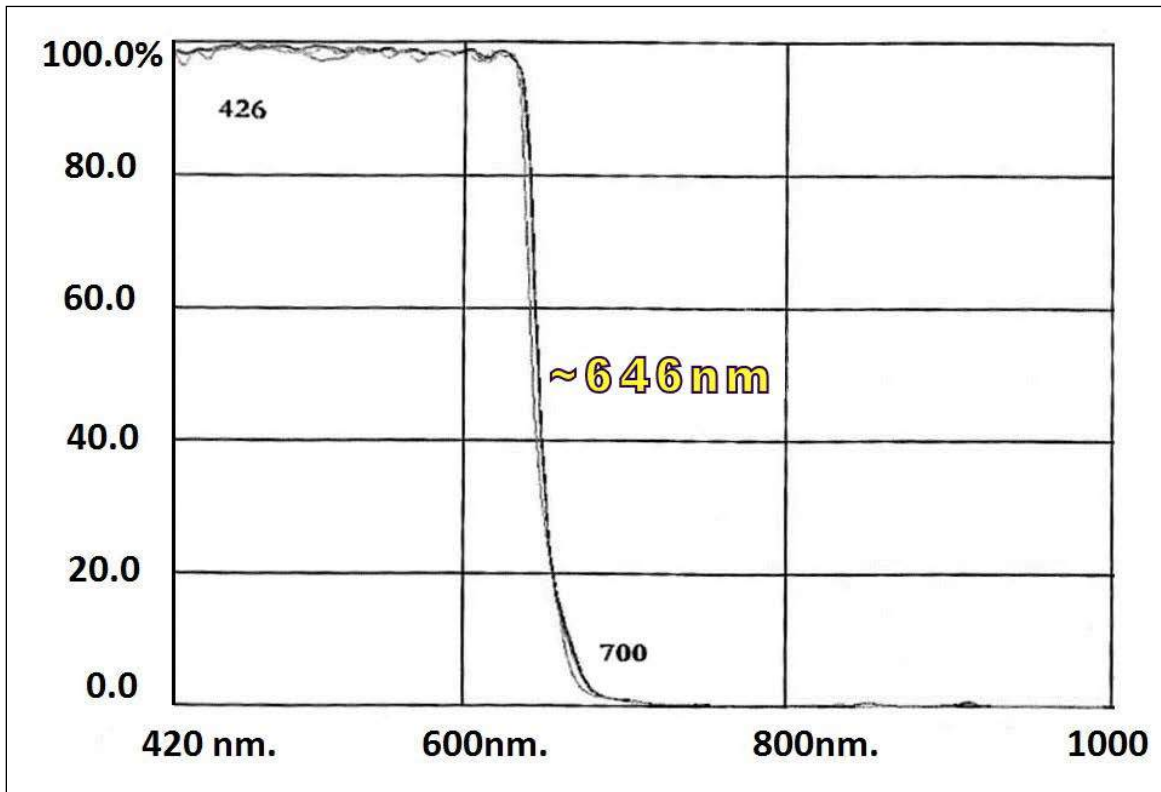

Guidelines for Choosing IR Cut-off Filters

The following graphic, using a color sensor response spectrum, shows the transmission response of typical filters designed for CMOS sensor cameras. When selecting an IR cut-off filter, choose a near infrared blocking specification of ~650nm. Filters that block at 700nm or longer wavelengths, designed for CCD cameras, are not recommended for Genie Nano color cameras.

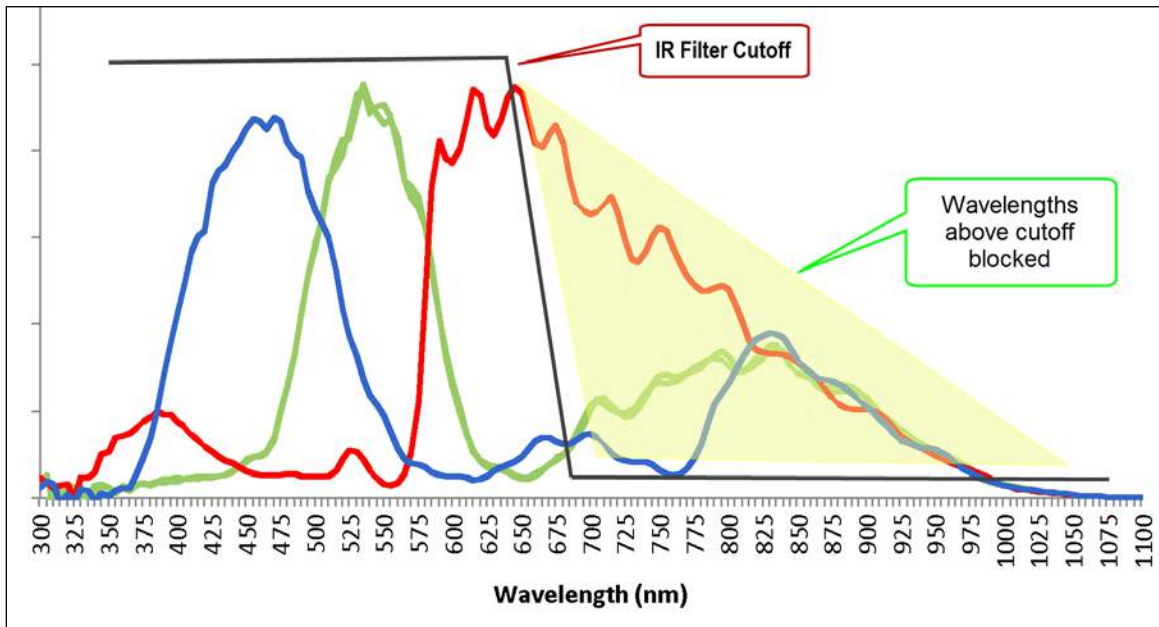

Back Focal Variance when using any Filter

Inserting a filter between a lens and sensor changes the back focal point of the lens used. A variable focus lens simply needs to be adjusted, but in the case of a fixed focus lens, the changed focal point needs correction.

The following simplified illustration describes this but omits any discussion of the Optics, Physics, and the math behind the refraction of light through glass filter media.

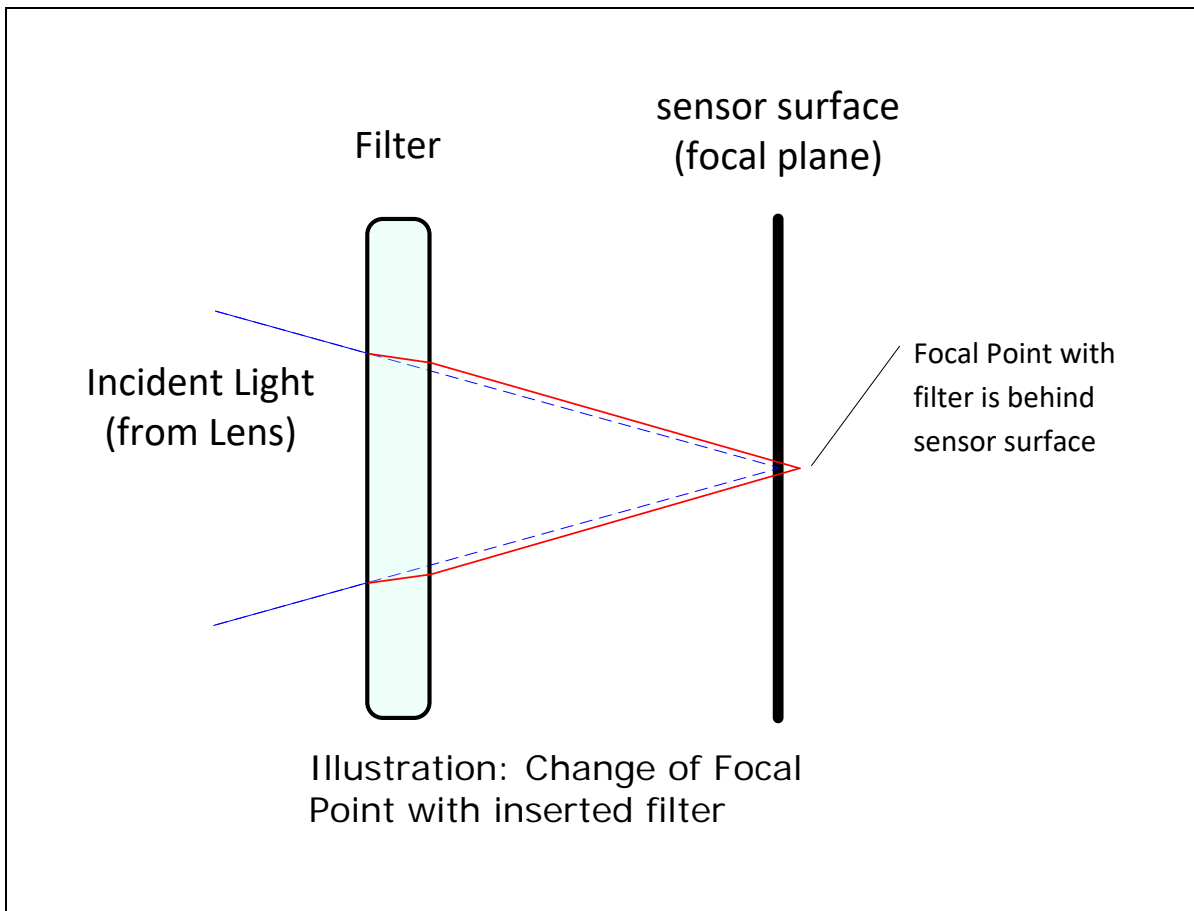

In this example when a glass filter is inserted between the lens and the camera sensor, the focal point is now about 1/3 of the filter thickness behind the sensor plane. Genie Nano filters are specified as 1mm thick.

Genie Nano models with factory installed filters automatically compensate for the focal point variance by having the sensor PCB mounted deeper within the camera body.

For Nano models normally shipped without filters, when a filter is installed a fixed focus lens requires a 1/3mm C-mount shim (spacer) added to move the lens focal point back to the sensor surface. Such shims are available from filter and lens suppliers. Alternatively use a variable focus lens and secure its focus ring after adjustment.

For users interested in installing their own choice of filters, please refer to application note:

G3-AN0001 – Installing Custom Filters into Genie Nano.pdf

available here <http://www.teledynedalsa.com/imaging/knowledge-center/appnotes/>

Lens Modeling

Any lens surrounded by air can be modeled for camera purposes using three primary points: the first and second principal points and the second focal point. The primary points for a lens should be available from the lens data sheet or from the lens manufacturer. Primed quantities denote characteristics of the image side of the lens. That is, h is the object height and h' is the image height.

The focal point is the point at which the image of an infinitely distant object is brought to focus. The effective focal length (f') is the distance from the second principal point to the second focal point. The back focal length (BFL) is the distance from the image side of the lens surface to the second focal point. The object distance (OD) is the distance from the first principal point to the object.

Primary Points in a Lens System

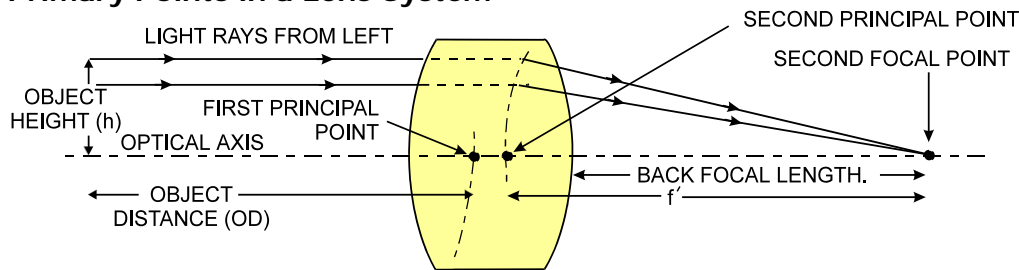

Magnification and Resolution

The magnification of a lens is the ratio of the image size to the object size:

$m = \frac{h'}{h}$	Where m is the magnification, h' is the image height (pixel size) and h is the object height (desired object resolution size).
--------------------	--

By similar triangles, the magnification is alternatively given by:

$m = \frac{f'}{OD}$

These equations can be combined to give their most useful form:

$\frac{h'}{h} = \frac{f'}{OD}$	This is the governing equation for many object and image plane parameters.
--------------------------------	--

Example: An acquisition system has a 512 x 512 element, 10 μ m pixel pitch area scan camera, a lens with an effective focal length of 45mm, and requires that 100 μ m in the object space correspond to each pixel in the image sensor. Using the preceding equation, the object distance must be 450mm (0.450m).

$\frac{10\mu m}{100\mu m} = \frac{45mm}{OD}$	$OD = 450mm(0.450m)$
--	----------------------

Sensor Handling Instructions

This section reviews proper procedures for handling, cleaning, or storing the Genie Nano camera. Specifically the Genie Nano sensor needs to be kept clean and away from static discharge to maintain design performance.

Electrostatic Discharge and the Sensor

Cameras sensors containing integrated electronics are susceptible to damage from electrostatic discharge (ESD).

Electrostatic charge introduced to the sensor window surface can induce charge buildup on the underside of the window that cannot be readily dissipated by the dry nitrogen gas in the sensor package cavity. With charge buildup, problems such as higher image lag or a highly non-uniform response may occur. The charge normally dissipates within 24 hours and the sensor returns to normal operation.



Important: Charge buildup will affect the camera's flat-field correction calibration. To avoid an erroneous calibration, ensure that you perform flat-field correction only after a charge buildup has dissipated over 24 hours.

Protecting Against Dust, Oil and Scratches

The sensor window is part of the optical path and should be handled like other optical components, with extreme care.

Dust can obscure pixels, producing dark patches on the sensor response. Dust is most visible when the illumination is collimated. The dark patches shift position as the angle of illumination changes. Dust is normally not visible when the sensor is positioned at the exit port of an integrating sphere, where the illumination is diffuse.

Dust can normally be removed by blowing the window surface using a compressed air blower, unless the dust particles are being held by an electrostatic charge, in which case either an ionized air blower or wet cleaning is necessary.

Oil is usually introduced during handling. Touching the surface of the window barehanded will leave oily residues. Using rubber finger cots and rubber gloves can prevent oil contamination. However, the friction between the rubber and the window may produce electrostatic charge that may damage the sensor.

Scratches can be caused by improper handling, cleaning or storage of the camera. When handling or storing the Nano camera without a lens, always install the C-mount protective cap. Scratches diffract incident illumination. When exposed to uniform illumination, a sensor with a scratched window will normally have brighter pixels adjacent to darker pixels. The location of these pixels changes with the angle of illumination.

Cleaning the Sensor Window

Even with careful handling, the sensor window may need cleaning. The following steps describe various cleaning techniques to clean minor dust particles to accidental finger touches.

- Use compressed air to blow off loose particles. This step alone is usually sufficient to clean the sensor window. Avoid moving or shaking the compressed air container and use short bursts of air while moving the camera in the air stream. Agitating the container will cause condensation to form in the air stream. Long air bursts will chill the sensor window causing more condensation. Condensation, even when left to dry naturally, will deposit more particles on the sensor.
- When compressed air cannot clean the sensor, Teledyne DALSA recommends using lint-free ESD-safe cloth wipers that do not contain particles that can scratch the window. The Anticon Gold 9"x 9" wiper made by Milliken is both ESD safe and suitable for class 100 environments. Another ESD acceptable wiper is the TX4025 from Texwipe.
- An alternative to ESD-safe cloth wipers is Transplex swabs that have desirable ESD properties. There are several varieties available from Texwipe. Do not use regular cotton swabs, since these can introduce static charge to the window surface.
- Wipe the window carefully and slowly when using these products.

Ruggedized Cable Accessories

Teledyne DALSA provides optional I/O cable assemblies for Genie Nano. Users wishing to build their I/O cabling by starting from available cable packages should consider these popular assemblies described below. Contact Sales for pricing and delivery.

Users also may order cable assembly quantities directly from Alysium-Tech or Components Express. In such cases use the manufacturer's part number shown on the cable assembly engineering drawing.

Cable Manufactures Contact Information

For Information contact: <i>(see their web site for worldwide offices)</i>	Alysium-Tech 101 Montgomery Street, Suite 2050 San Francisco, CA 94104 Phone: 415 248 7807 Fax: 415 248 7800 https://www.alysium.com/
--	---

For Information contact: <i>(see their web site for worldwide offices)</i>	Components Express, Inc. (CEI) 10330 Argonne Woods Drive, Suite 100 Woodridge, IL 60517-4995 Phone: 630-257-0605 / 800.578.6695 (outside Illinois) Fax: 630-257-0603 http://www.componentsexpress.com/
--	---

Cable Assembly G3-AIOC-BLUNT1M

ALYSIUM
EVOLUTIONARY INTERCONNECTS

DRAWING REF: **A65-3210**
IO Industrial Assembly
REVISION: 00 (WON: 161207) Initial Issue

Length (in meter), As per Customer Requirements

(29.2) (16.9) (30)

#1 Mating Face View

xx.xM XYZ

4 CABLE LABEL DETAIL
Micro traceable for "Date Code, Romm"
xx.xM XYZ
Specified Cable Length
Week
Year

UNLESS OTHERWISE SPECIFIED
ASSY LENGTH TOLERANCE
 $< 150\text{mm} = \pm 10$
 $\geq 150\text{mm}$ and $\leq 250\text{mm} = \pm 15$
 $\geq 250\text{mm}$ and $\leq 500\text{mm} = \pm 20$
 $\geq 500\text{mm}$ and $\leq 1000\text{mm} = \pm 30$
 $\geq 1000\text{mm}$ and $\leq 5000\text{mm} = \pm 50$
 $> 5000\text{mm}$ and above = ± 100

BILL OF MATERIALS

Item	Description
1	10P(1.27) DRsl (DCT)
2	Samtech (SFM Series Pitch 0.050" 10P Dual Row)
3	TBA - 10C#30 Cable
4	Processed End - Flat Cut Cable Label
5	Heat Seal PE Bag

WIRING DIAGRAM

1	BLACK
2	RED
3	BROWN
4	ORANGE
5	YELLOW
6	GREEN
7	BLUE
8	VIOLET
9	GREY
10	SHIELD

PACKAGING DETAIL

RoHS COMPLIANT

This document is the property of Alysium-Tech. It must not be copied or otherwise disclosed without prior written consent.

Cable Assembly G3-AIOC-BLUNT2M

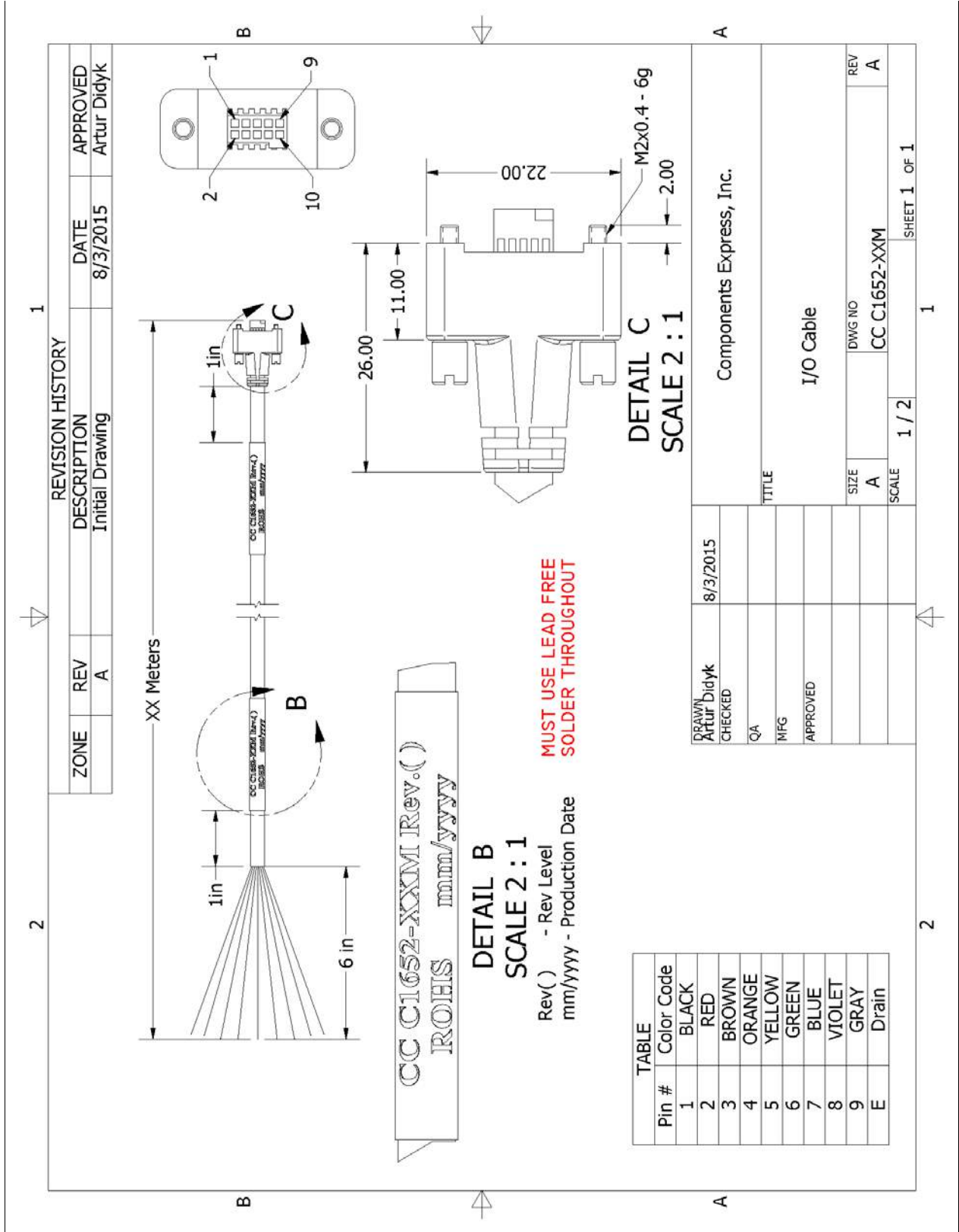



Cable Assembly G3-AIOC-BRKOUT2M

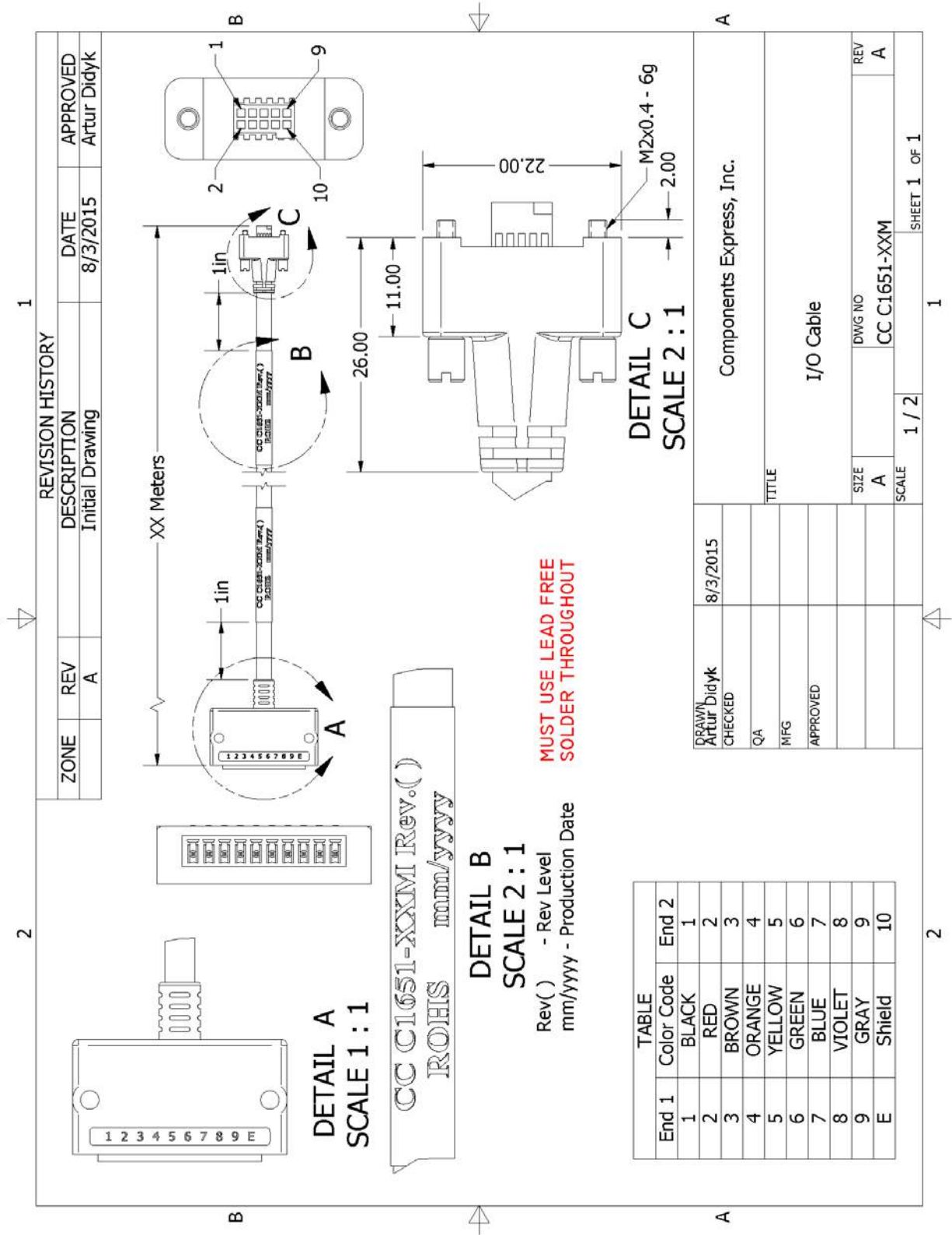



Nano Generic Power Supply with no I/O

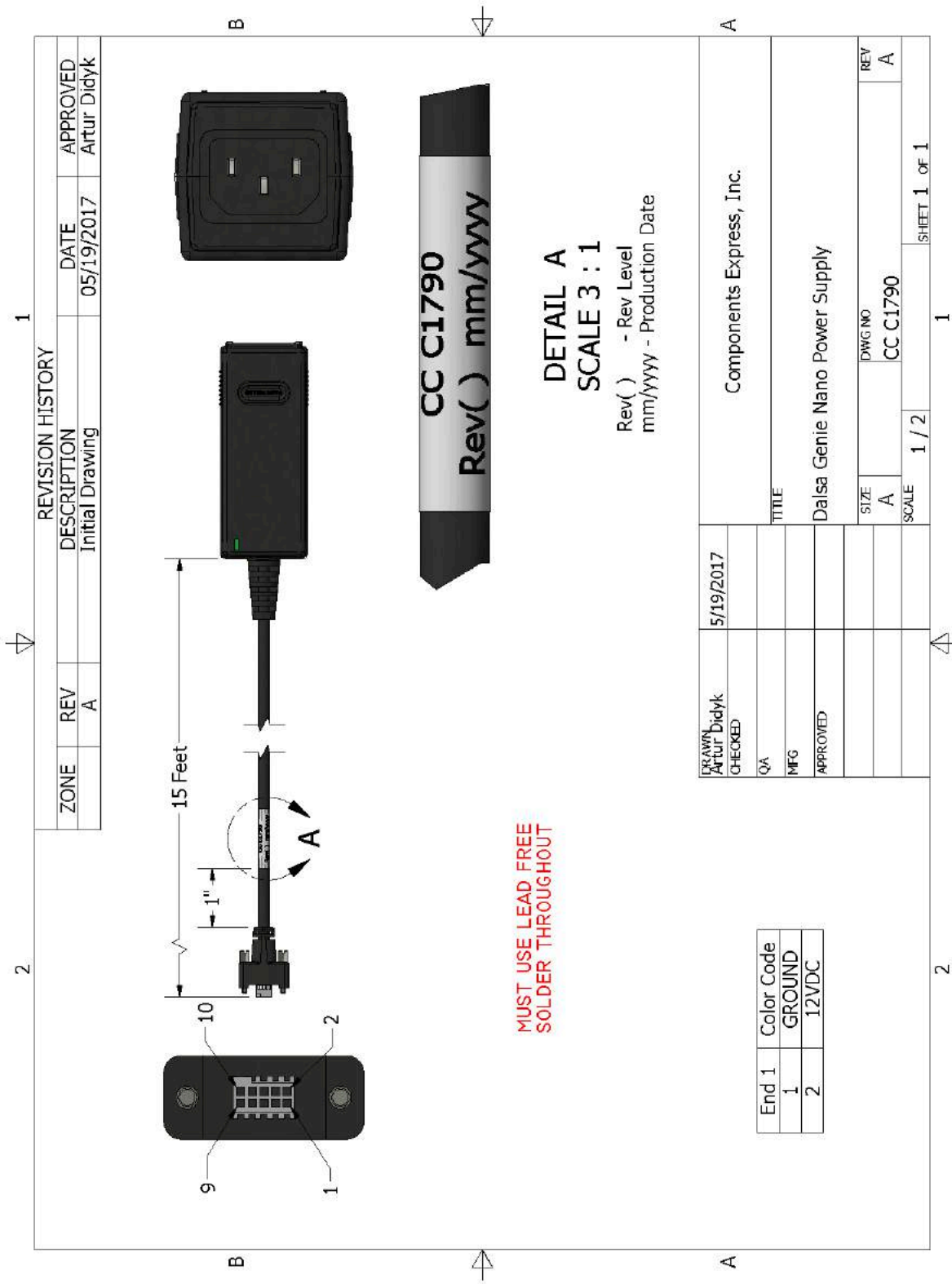

REVISION HISTORY				
ZONE	REV	DESCRIPTION	DATE	APPROVED
	A	Initial Drawing	05/19/2017	Artur Didyk

DRAWN Artur Didyk	5/19/2017	TITLE Dalsa Genie Nano Power Supply	
CHECKED		COMPONENTS EXPRESS, INC.	
QA			
MFG			
APPROVED			
		SIZE A	DWG NO CC C1790
		SCALE 1 / 2	REV A
		SHEET 1 OF 1	

End 1	Color Code
1	GROUND
2	12VDC

Components Express Right-Angle Cable Assemblies

These cable assemblies can be acquired directly from our partner [Components Express](#). In such cases use the manufacturer's part number shown on the cable assembly engineering drawing.

Cable Assembly: Right-Angle I/O Bunt End

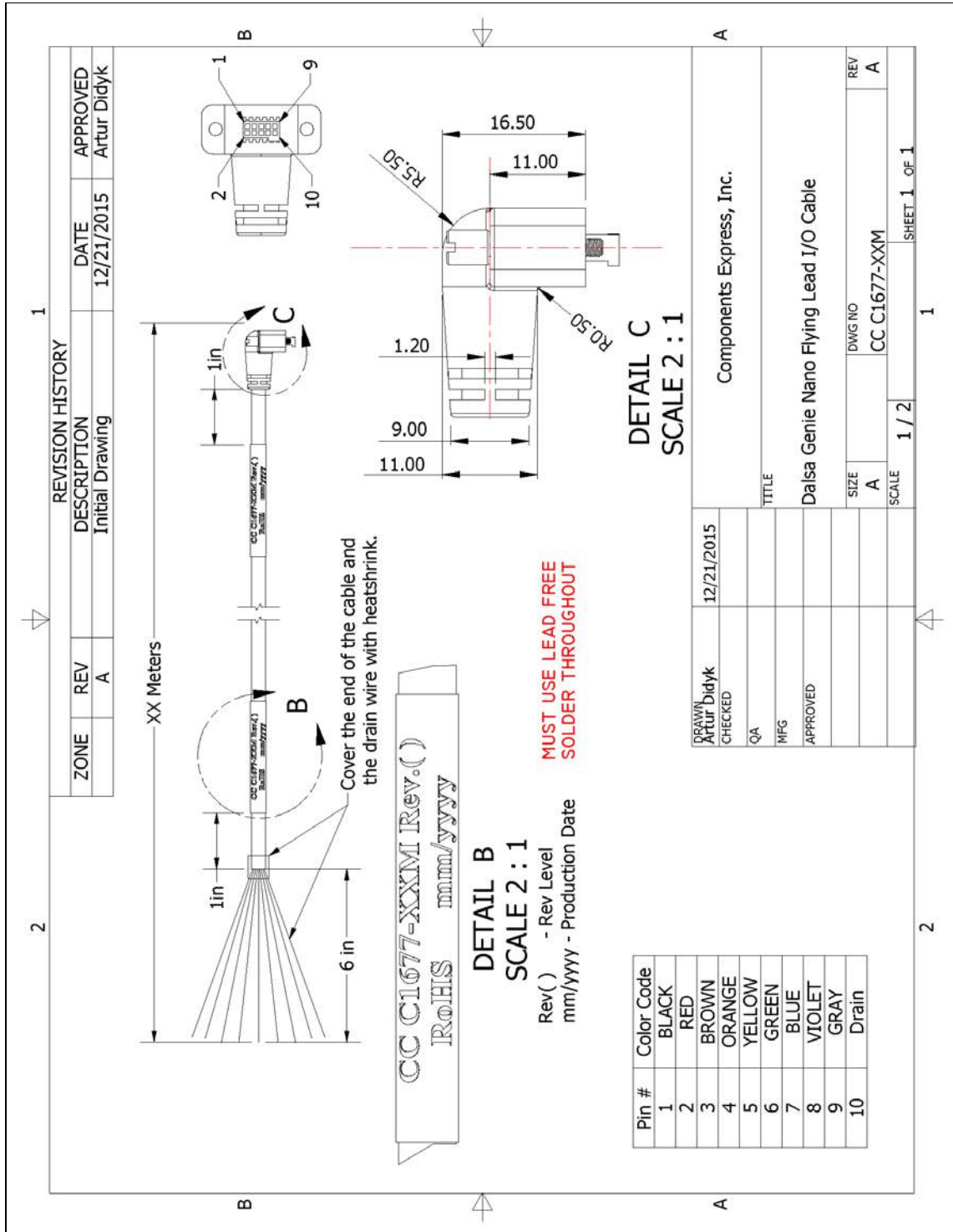

Cable Assembly: Right-Angle I/O to Euro Block

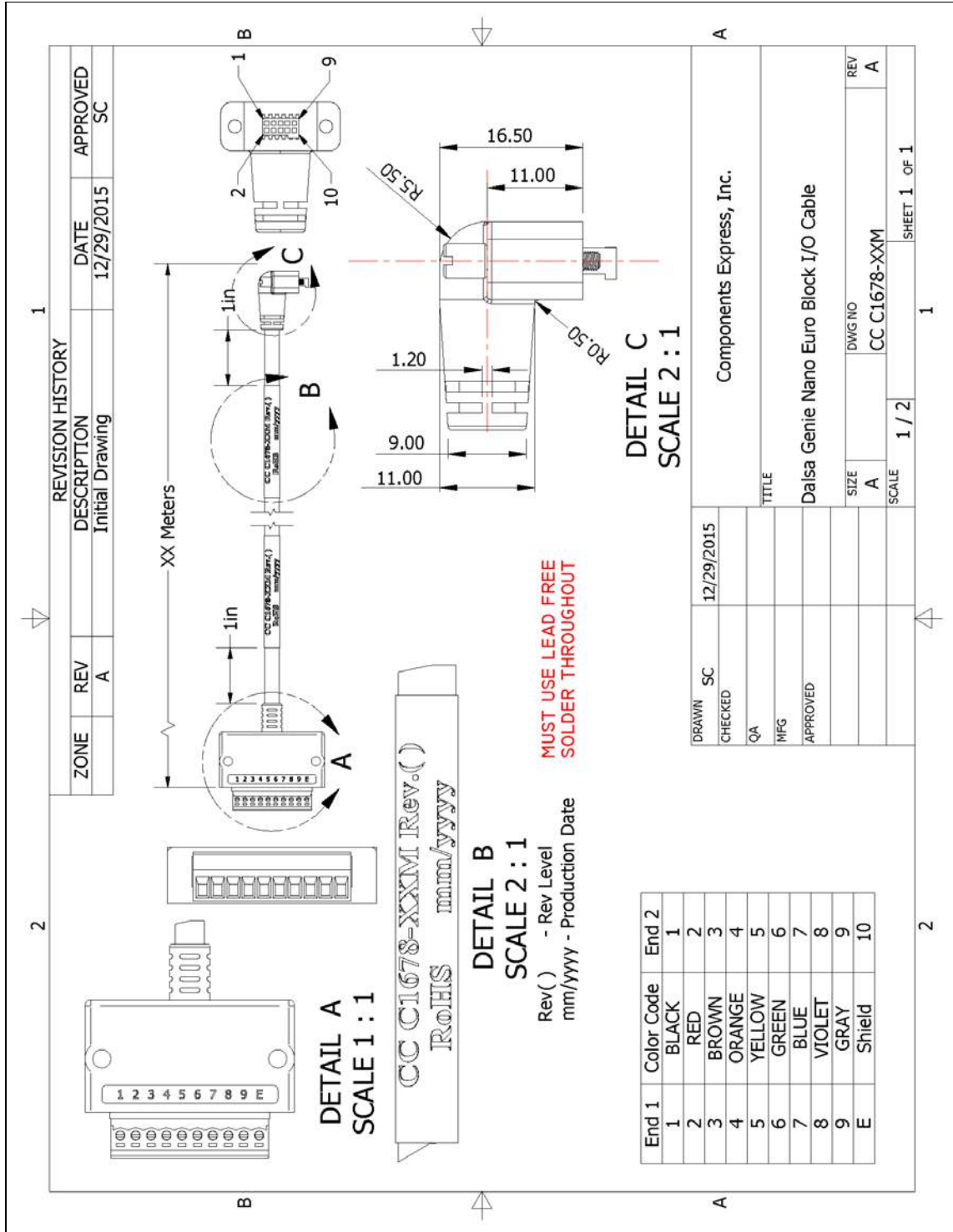

Ruggedized RJ45 Ethernet Cables

Components Express Inc. has available industrial RJ45 CAT6 cables that on one end have a molded shroud assembly with top/bottom thumbscrews, while the other end is a standard RJ45 (one example shown below). These cables are recommended when Nano is installed in a high vibration environment. All Nano versions support this secure Ethernet cable. Review their catalog for all available versions of vertical thumbscrew RJ45 cable sets.



All cables made in U.S.A. – all cables RoHS compliant.	CAT6 certified (tested for near end / far end crosstalk and return loss). IGE-3M (3meters) IGE-10M (10meters) IGE-25M (25meters) IGE-50M (50meters) IGE-100M (100meters)
---	--

Cable Assembly: Right-Angle Ethernet

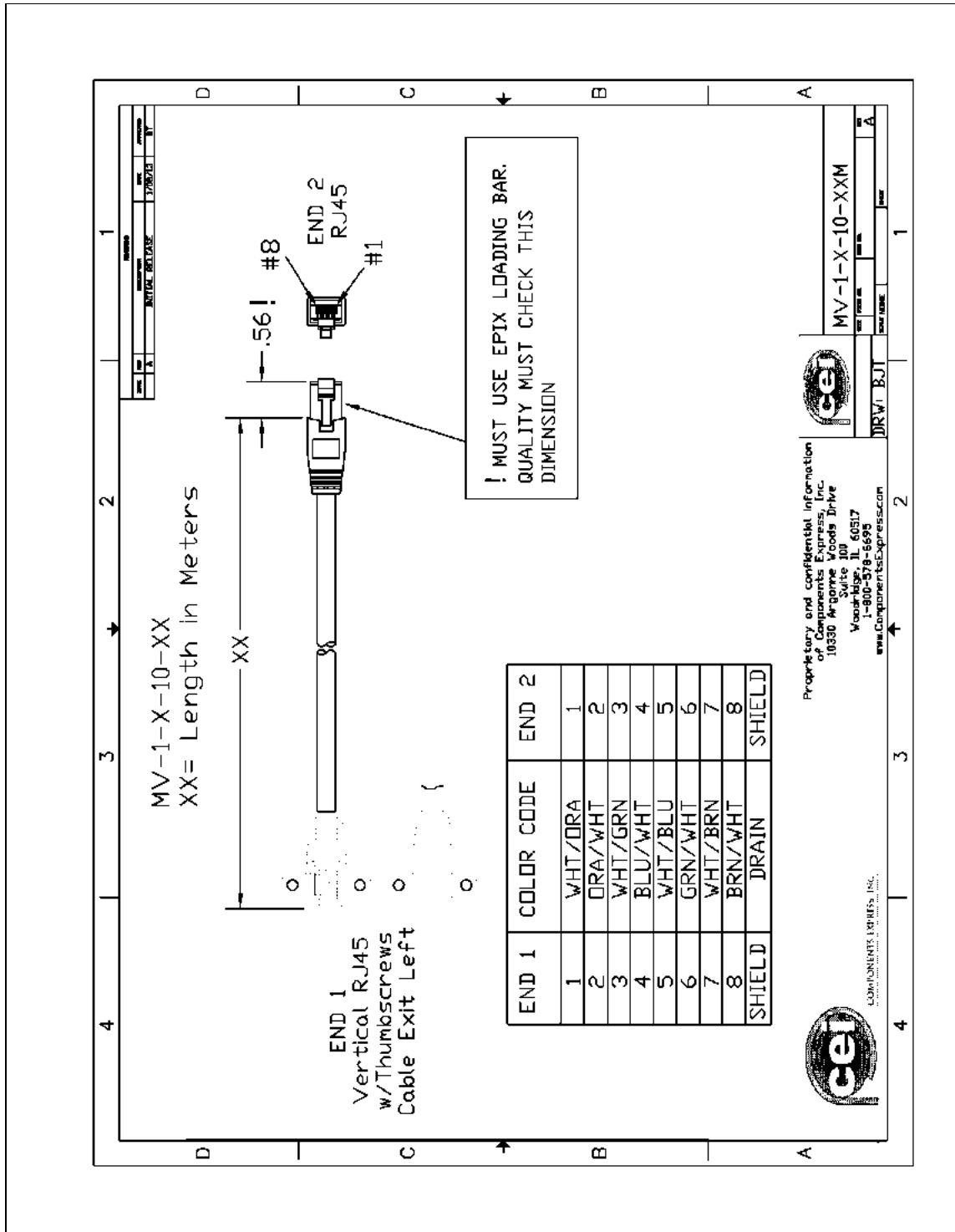

Right-Angle Cable-Set (Mounted)

Photos show the Components Express Right-Angle combo package (**CC C1679-xxM**) consisting of a Right-Angle Ethernet cable, Right-Angle I/O to Euro Block, and power supply (not shown).





Troubleshooting

Overview

In rare cases an installation may fail or there are problems in controlling and using the Nano camera. This section highlights issues or conditions which may cause installation problems and additionally provides information on computers and network adapters which have caused problems with Nano. Emphasis is on the user to perform diagnostics with the tools provided and methods are described to correct the problem.

The GigE Server status provides visual information on possible Nano problems. The three states are shown in the following table. Descriptions of possible conditions causing an installation or operational problem follow. Note that even a Nano installation with no networking issue may still require optimization to perform to specification.

	Device Not Available	Device IP Error	Device Available
GigE Server Tray Icon:			
Note: It will take a few seconds for the GigE Server to refresh its state after any change.	A red X will remain over the GigE server tray icon when the Nano device is not found. This indicates a network issue where there is no communication with Nano. Or in the simplest case , the Nano is not connected.	The GigE server tray icon shows a warning when a device is connected but there is some type of IP error.	The GigE server tray icon when the Nano device is found. The Nano has obtained an IP address and there are no network issues. Optimization may still be required to maximize performance.

Important: 10/100 Mb Ethernet is not supported by the Genie Nano series of cameras. The Genie Nano status LED will show that it acquired an IP address (solid Blue) but the Nano will not respond or function at these slower connections.

Problem Type Summary

Nano problems are either installation types where the Nano is not found on the network or setup errors where the Nano device is found but not controllable. Additionally a Nano may be properly installed but network optimization is required for maximum performance. The following links jump to various topics in this troubleshooting section.



Device Not Available

A red X over the GigE server tray icon indicates that the Nano device is not found. This indicates either a major camera fault or condition such as disconnected power, or a network issue where there is no communication.

- Review the section Using Nano to verify required installation steps.
- Refer to the Teledyne DALSA Network Imaging manual to review networking details.

- In multiple NIC systems where the NIC for the Nano is using LLA mode, ensure that no other NIC is in or switches to LLA mode. It is preferable that the Teledyne DALSA DHCP server is enabled on the NIC used with the Nano instead of using LLA mode, which prevents errors associated with multiple NIC ports.
- Verify that your NIC is running the latest driver available from the manufacturer.



Device IP Error

The GigE server tray icon shows a warning with IP errors. Review the following topics on network IP problems to identify and correct the condition.

Please refer to the Teledyne DALSA Network Imaging Package manual for information on the Teledyne DALSA Network Configuration tool and network optimization for GigE Vision cameras and devices.

Multiple Camera Issues

- When using multiple cameras with a computer with multiple NIC ports, confirm each Nano has been assigned an IP address by checking the GigE server.
- To reduce network traffic in configured problem free systems, use the Network Configuration tool to stop camera discovery broadcasts. Refer to the Teledyne DALSA Network Imaging manual.
- When using multiple cameras connected to an VLAN Ethernet switch, confirm that all cameras are on the same subnet setup on that switch. See the Teledyne DALSA Network Imaging package manual for more information. .
- If a Nano camera installed with other GigE Vision cameras cannot connect properly with the NIC or has acquisition timeout errors, there may be a conflict with the third party camera's filter driver. In some cases third party filter drivers modify the NIC properties such that the Teledyne DALSA Sopera Network Imaging Driver does not install. Verify such a case by uninstalling the third party driver and installing the Nano package again.
- Verify that your NIC is running the latest driver available from the manufacturer.



Device Available but with Operational Issues

A properly installed Nano with no network issues may still not perform optimally. Operational issues concerning cabling, Ethernet switches, multiple cameras, and camera exposure are discussed in the following sections:

Always Important

- Why should Nano firmware be updated? See Firmware Updates.
- Power Failure during a Firmware Update—Now What?
- Cabling and Communication Issues
- See Preventing Operational Faults due to ESD to avoid random packet loss, random camera resets, and random loss of Ethernet connections.

No Timeout messages

- I can use CamExpert to grab but the image is corrupted with bad data. See Grab has Random Bad Data or Noise.
- I can use CamExpert to grab (with no error message) but there is no image (display window stays black). See Acquisition Error without Timeout Messages.
- I can use CamExpert to grab (with no error message) but the frame rate is lower than expected. See Camera acquisition is good but frame rate is lower than expected.

- There is no image but the frame rate is as expected.
See Camera is functional, frame rate is as expected, but image is black.

Other problems

- Unexpected or missing 'Trigger Events'. See Random Invalid Trigger Events.
- Dropped packets or lost frames when using newer CPU system. See [Preventing Dropped Packets by adjusting Power Options](#).

Verifying Network Parameters

Teledyne DALSA provides the Network Configuration tool to verify and configure network devices and the Nano network parameters. See section Network Configuration Tool of the Teledyne DALSA Network Imaging manual, if there were any problems with the automatic Nano software installation.

Before Contacting Technical Support

Carefully review the issues described in this Troubleshooting section. To aid Teledyne DALSA personnel when support is required, the following should be included with the request for support.

- From the Start menu, go to **Programs • Dalsa • Sopera LT • Tools** and run the **Log Viewer** program. From its File menu click on **Save Messages** to generate a log text file.
- Report the version of Genie Nano Framework and Sopera version used.

Device Available with Operational Issues

This section considers issues with cabling, Ethernet switches, multiple cameras, and camera exposure. All information concerning the Teledyne DALSA Network Configuration Tool and other networking considerations, is available in the **Teledyne DALSA Network Imaging manual**.

Firmware Updates

As a general rule any Nano installation must include the firmware update procedure (see File Access Control Category). Nano camera firmware that does not match a newer version of installed Nano Framework software is likely to have unpredictable behavior.

Problems might be:

- Nano is not found by the device discovery process.
- Nano is found by the Sopera GigE Server but an application such as CamExpert does not see the camera.
- A Nano that had a fault with a firmware update will automatically recover by booting with the previous firmware version.



Important: New Nano cameras installed in previously deployed systems are fully backward compatible with the older vision application.

Power Failure during a Firmware Update—Now What?

Don't panic! There is far greater chance that the host computer OS is damaged during a power failure than any permanent problems with the Nano. When electrical power returns and the host computer system has started, follow this procedure.

- Connect power to the Nano. The Nano processor knows that the firmware update failed.
- The Genie Nano will boot with the previous version of firmware and will operate normally.
- The [Nano Self Status](#) (deviceBISTStatus) will return that the last firmware update failed.
- Perform the firmware update procedure (see File Access Control Category) again.

Cabling and Communication Issues

With only two cables connected to Nano, possible cabling issues are limited.

Power supply problems:

- If the Nano status LED is off, the DC supply power is not connected or faulty. Verify the power supply voltage.

Communication Problems:

- Use a shielded cable where the connector shell electrically connects the Nano chassis to the power supply earth ground. This can eliminate trigger issues in a high EMI environment.
- Check that the Ethernet cable is clipped both to the Nano and the NIC or switch on the other end.
- Verify the Ethernet cabling. Poor cables will cause connections to auto-configure at lower speeds.
- Use a secured Ethernet cable when the Nano is in a high vibration environment. See Ruggedized RJ45 Ethernet Cables.
- Check the Ethernet status LEDs on the NIC used with the camera. The Link Status indicator is on and the activity LED should flash with network messages.
- Verify that the Ethernet cable is CAT5e or CAT6. This is very important with long cable lengths.
- When using very long cables, up to the maximum specified length of 100m for gigabit Ethernet, different NIC hardware and EMI conditions can affect the quality of transmission.
- Minimum recommended Ethernet cable length is 3 feet (1 meter).
- Use the Log Viewer tool (see point below) to check on packet resend conditions.
- Run the Sapera Log Viewer: **Start•Programs•Teledyne DALSA•Sapera LT•Tools•Log Viewer**. Start the Nano acquisition program, such as CamExpert. There should not be any "packet resend" messages, else this indicates a control or video transmission problem due to poor connections or extremely high EMI environments.

Acquisition Error without Timeout Messages

Streaming video problems range from total loss of image data to occasional loss of random video data packets. The following section describes conditions identified by Teledyne DALSA engineering while working with Nano in various computers and setups. See the Teledyne DALSA Network Imaging manual for information on network optimizations.

Grab has Random Bad Data or Noise

The problem is seen as random noise and missing sections of video data from the acquisition. All configuration parameters seem correct and the Ethernet cable is secure. The following image shows an example of this type of bad acquisition while testing a Genie installation with CamExpert.



- This problem has been seen with network adapters that do not support jumbo frames but still report a false maximum packet frame size.
- Test for a good acquisition by reducing the camera packet size used. Set the value to the default value of 1500 to verify acquisition before trying a higher value.
- Other marginal NIC boards or ports can cause problems with packet transfers. Try alternative NIC adapters.

Review other reasons for such acquisition errors as described in the **Teledyne DALSA Network Imaging Module for Sopera LT** manual.

No camera exposure when expected

- Verify by using the camera in free-running mode. Do not use external trigger mode when testing a camera setup.
- If using free-running mode, verify that the exposure period is set to the maximum possible for the set frame rate.
- Load the factory default from the Power-up Configuration in CamExpert. This will reset the camera to its nominal acquisition rate.

Camera acquisition is good but frame rate is lower than expected

- While running CamExpert and grabbing in free run mode, check the GigE Vision Transport Layer Control to verify and possibly increase the Interpacket Delay. In multi-camera setups using a Gigabit Ethernet switch, the Device Link Throughput may need to be reduced so that each camera can equally share the available bandwidth.
- While running CamExpert and grabbing in free-run mode at the maximum frame rate, start the **Sapera Monitor** tool from the Sapera Tools installed with Sapera.
- Make sure the **Memory Overflow** event monitor is enabled.
- Continue grabbing from the Nano at maximum frame rate. If any memory overflow events are counted, then the Nano internal buffer could not be transmitted on time and was discarded. Such a condition may occur with large frame color or high frame rate Nano cameras.
- Note that the Sapera CamExpert tool has limits to the maximum frame rate possible due to CamExpert generating an interrupt for each acquired frame. The Sapera Grab Demo may be better suited for testing at higher frame rates.
- Verify that network parameters are optimal as described in the Teledyne DALSA Network Imaging Module manual. Ensure the host computer is not executing other network intensive tasks. Try a different Gigabit NIC.
- Note that a changed acquisition frame rate becomes active only when the acquisition is stopped and then restarted.
- If using an external trigger, verify the trigger source rate and Nano parameters such as trigger to exposure delay.
- USB to Ethernet adapters are not recommended nor guaranteed. Even in cases where the camera seems to be connected and transferring images, reports of random disconnections are common. If the user wishes to try such an interface, limit this to just one high quality unit, never more. Multiple units have not worked in a machine vision environment.

Camera is functional, frame rate is as expected, but image is black

- Verify that the lens iris is open.
- Aim the Nano at a bright light source.
- Check that the programmed exposure duration is not too short or set it to maximum. See Sensor Control Category.
- Using CamExpert set the Nano to output its Internal Pattern Generator. This step is typically done for any camera installation to quickly verify the Nano and its software package. See Internal Test Pattern Generator for information on using CamExpert to select internal patterns from Nano.

Model C4900 Column Noise in Saturated Areas

Model C4900 cameras used in high temperature environments and exposed to light many times brighter than the pixel saturation threshold, might exhibit sensor artifacts visible as dark column noise in the saturated areas.

This is not a camera fault but just a sensor limitation, which varies from one camera to another. The image below shows an example of these artifacts in a lighting setup which over saturates the whole sensor.

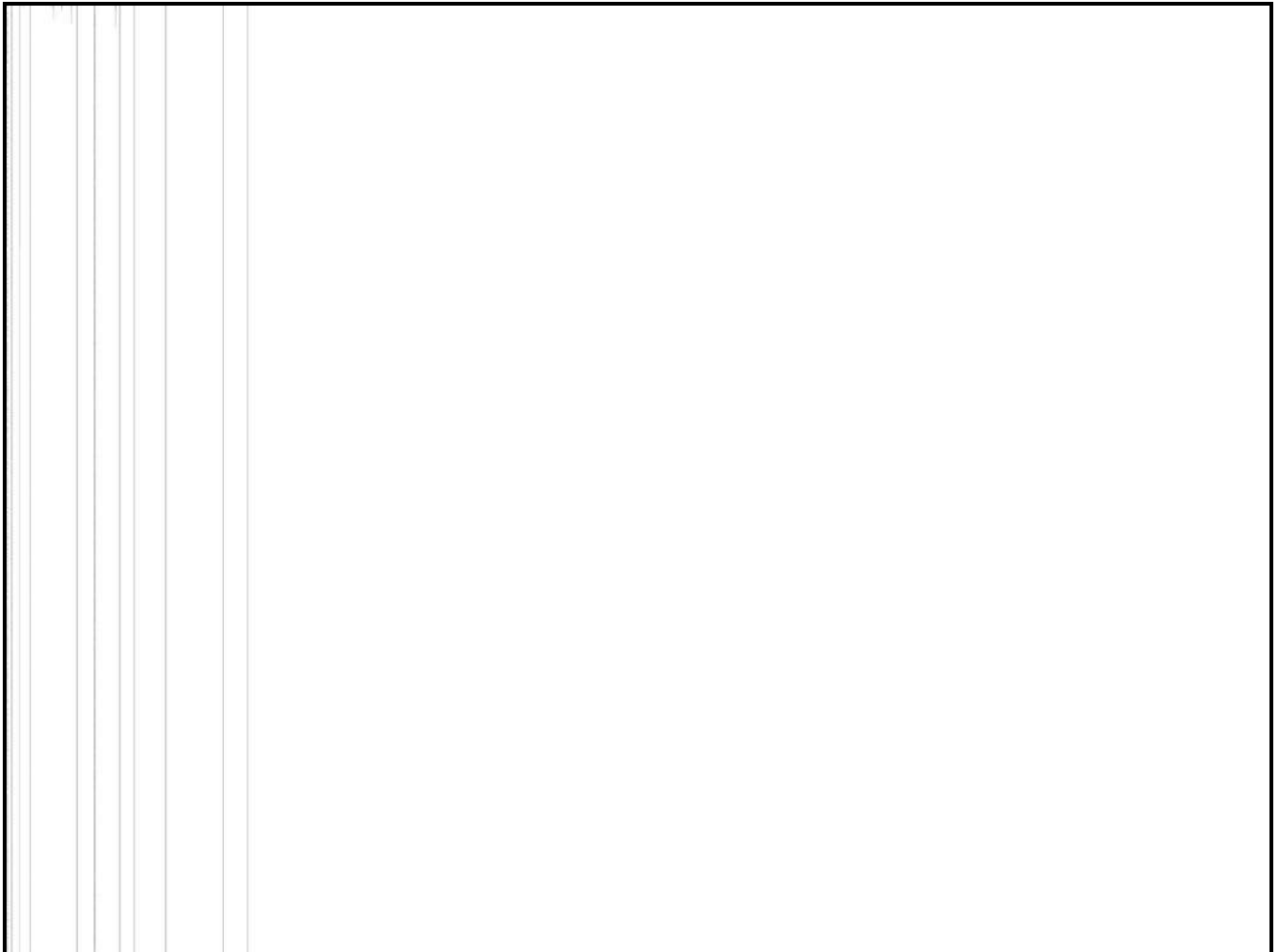

Other Problems or Issues

This section describes problems that do not fit any of the categories above. Typically these are issues found in the field under specific or unusual conditions.

Preventing Dropped Packets by adjusting Power Options

New computers using new generation CPU chips such as Intel Skylake require adjustments to the default Power Options to avoid possible dropped packets or frames.

- Open Control Panel – Power Options and select advanced settings, as shown below.
- Scroll down to the Processor Power Management control and change the Minimum Processor State to 100%.
- Disable the Sleep and Hibernate options to ensure continuous system operation.

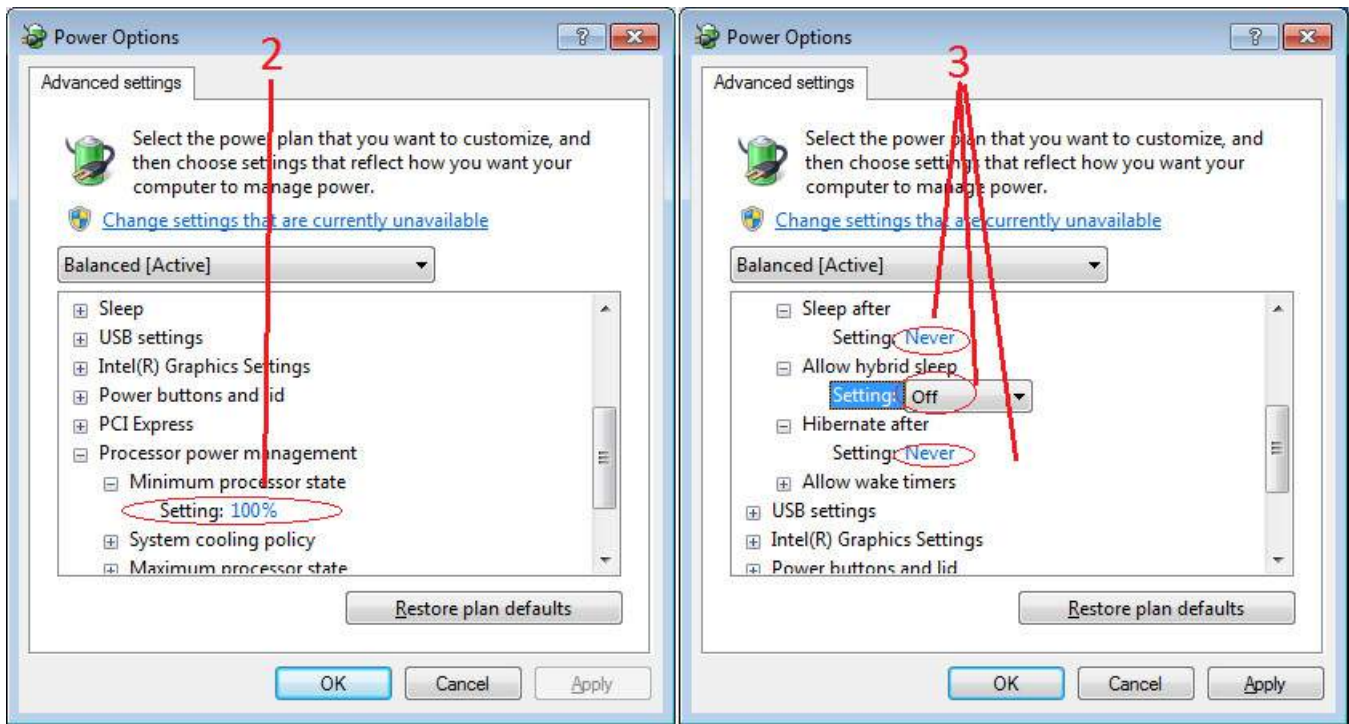

Random Invalid Trigger Events

- Do not change the exposure time while grabbing, else an Invalid Trigger Event may be generated. This applies to any exposure mode or trigger source. The Invalid Trigger Event is not catastrophic and only indicates the loss of a video frame. Stopping acquisitions first will avoid this error.
- Version 1.00 firmware may not correctly generate Invalid Trigger Events when triggers are received early (i.e. within the trigger exclusion period). All trigger management issues will be resolved with firmware 1.01.

Minimum Sapera Version Required

Save User Configuration Failed: An unusual error that occurred with no other Nano control problem. The solution is to verify the minimum Sapera version used with the Nano Framework. The Genie Nano requires Sapera version 8.00 or later.

Issues with uninstalling Cognex VisionPro with Sapera LT CamExpert

When the Cognex VisionPro package is uninstalled, the Genie Nano becomes not available within CamExpert due to the Cognex uninstaller removing GigE Vision components. This forces a Genie Nano user to reinstall the Network Imaging package (or execute a repair within Sapera LT).

Cognex VisionPro remains a useable third party product except for their uninstaller fault. Genie Nano users just need to account for this issue until resolved by Cognex.

Addendums

This section provides supplemental information about alternative Nano specifications pertaining to various models or legacy firmware revisions. For purchasing information and lead times of optional Nano models that are not part of the typical production cycle, contact Teledyne DALSA Sales.

AC Characteristics of 1 Input / 3 Output Models

Optional Nano models denoted by part numbers "G3-GM2..." or G3-GC2..." have output signal AC characteristics as defined in the following table. Input characteristics remain equal to standard Nano models.

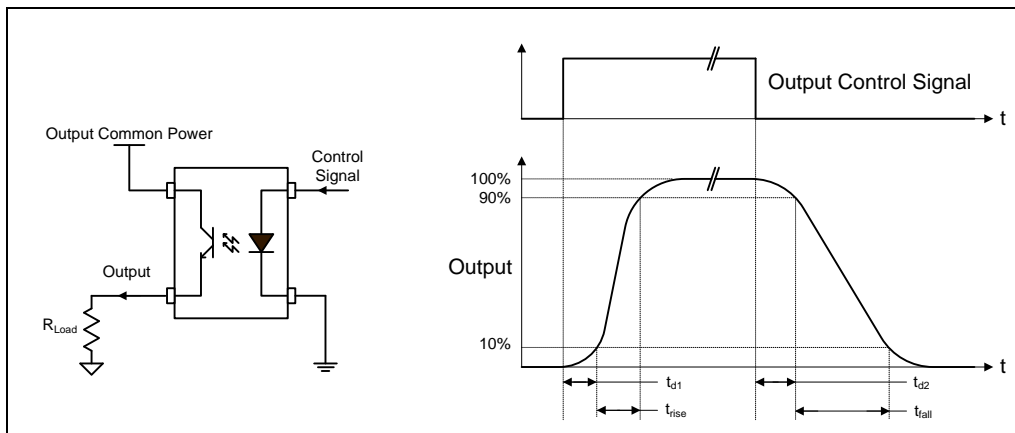

Opto-coupled Output: AC Characteristics at an internal FPGA temperature of 83C

Note: All measurements subject to some rounding.

Output Common Power	Output Current	R _{load} Test	Teledyne DALSA ₁ (μs) Leading Delay	t _{rise} (μs) Rise Time	Teledyne DALSA ₂ (μs) Trailing Delay	t _{fall} (μs) Fall Time
3V	8 mA	250 ohm	0.5	3.4	8.5	13.4
	16 mA	43 ohm	0.48	5.2	2.7	7.1
5V	8 mA	500 ohm	0.56	2.9	10.3	14.6
	16 mA	170 ohm	0.52	4.9	3.3	7.4
	21 mA	6.5 ohm	0.44	3.4	2.4	4.4
12V	8 mA	1.4K ohm	0.64	2.4	13.7	16.3
	16 mA	625 ohm	0.61	5.4	5.2	11.1
	24 mA	206 ohm	0.52	3.0	2.7	4.7
24V	8 mA	2.87K ohm	0.69	2.5	15.2	24.2
	16 mA	1.35K ohm	0.69	4.7	6.2	14.4
	24 mA	700 ohm	0.65	4.6	9.7	9.4

Defective Pixel Replacement (Method 4)

Important: The algorithms used exclusively with Nano firmware versions 1.00 to 1.06 are now identified as Method 4, as described in this addendum. Nano firmware 1.07 and later implements algorithms now identified as Method 3 and which are described in the image processing category.

The Pixel Replacement algorithm (Method 4) is based on a predefined bad pixel map (as an XML file), either supplied by the factory (file loaded as “Factory Map”) or generated by the user (file uploaded as “User Map 1”). The number of bad pixel entries is limited and varies dependent on the Nano model. The following XML code sample forms the template for the user to build bad pixel maps for any of their Nano cameras.

Note: Identifying bad pixels is left to the user’s discretion, but Teledyne DALSA technical support can provide guidance.

Example User Defective Pixel Map XML File

The following example shows the required components of the defective pixel map file. Each bad pixel position (relative to the image origin which is the upper left corner), must be identified by the XML statement:

```
<DefectivePixel OffsetX="number" OffsetY="number"/>
```

The pixel format (whether 8, 10, 12-bit) is handled transparently, thus requires no special consideration by the user.

This example XML listing has four “bad” pixels identified (maximum number of entries is model dependent). The Algorithm descriptions that follow define the rules used by the Nano firmware to replace an identified bad pixel.

```
<?xml version="1.0" encoding="UTF-8" ?>
<!--Example User Defective Pixel Map →
<!--      maximum 512 coordinates →
<!--filename: NanoExampleBadPixels.xml →

<Coordinates>

<DefectivePixel OffsetX="100" OffsetY="0"/>
<DefectivePixel OffsetX="28" OffsetY="345"/>
<DefectivePixel OffsetX="468" OffsetY="50"/>
<DefectivePixel OffsetX="800" OffsetY="600"/>

</Coordinates>
```

An sample editable defective pixel map replacement file will be available to download with Nano firmware files.

Monochrome Defective Pixel Replacement Algorithm Description

The replacement algorithm follows a few basic rules as defined below, which in general provides satisfactory results. There is no embedded intelligence to adapt the rules to avoid replacing a bad pixel with possibly other bad data.

Monochrome Sensors (case 1: single bad pixel)

- A bad even pixel is replaced by the good odd pixel of the same pixel pair.
- A bad odd pixel is replaced by the good even pixel of the same pixel pair.

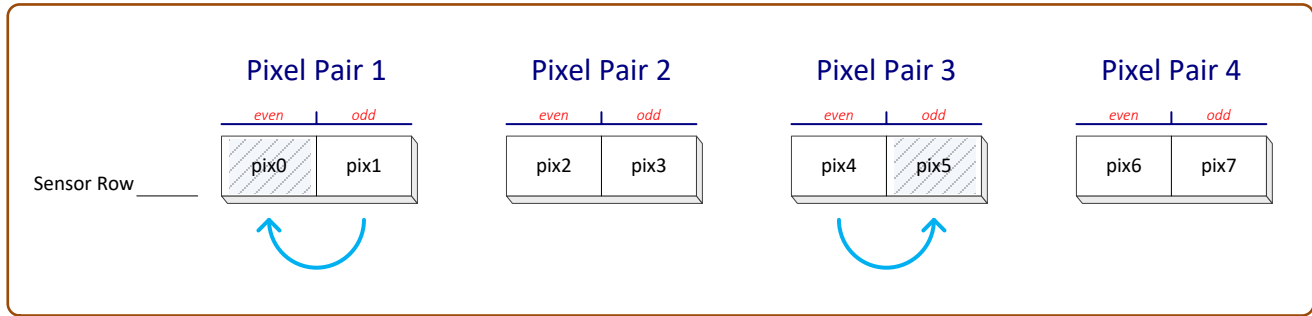

Monochrome Sensors (case 2: bad pixel pair)

- When a pixel pair has both even and odd pixels marked as bad, the even pixel is replaced by the preceding odd pixel and the odd pixel is replaced by the following even pixel (even if it is marked as a bad pixel).

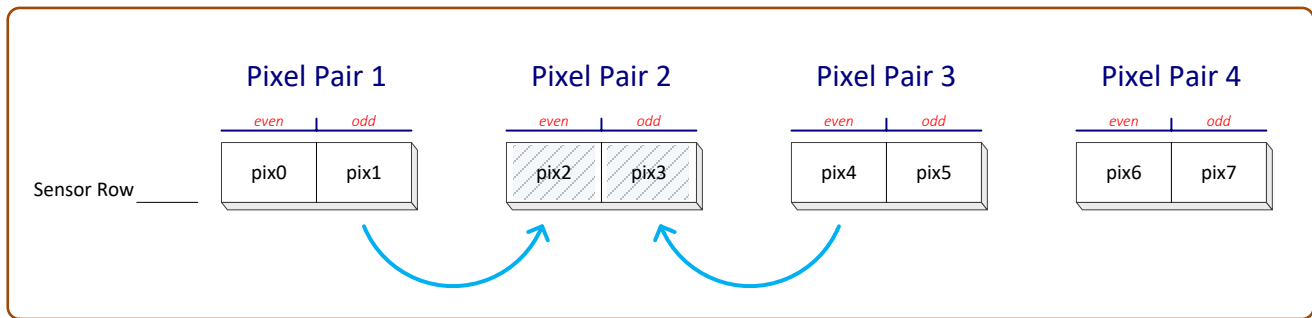

Monochrome Sensors (case 3: bad pixel pairs at boundaries)

- When the first pixel pair of the first image row has both even and odd pixels marked as bad, the even pixel is replaced by indeterminate data from the preceding memory location. The bad odd pixel is replaced by the following even pixel (even if it is also marked as a bad pixel).

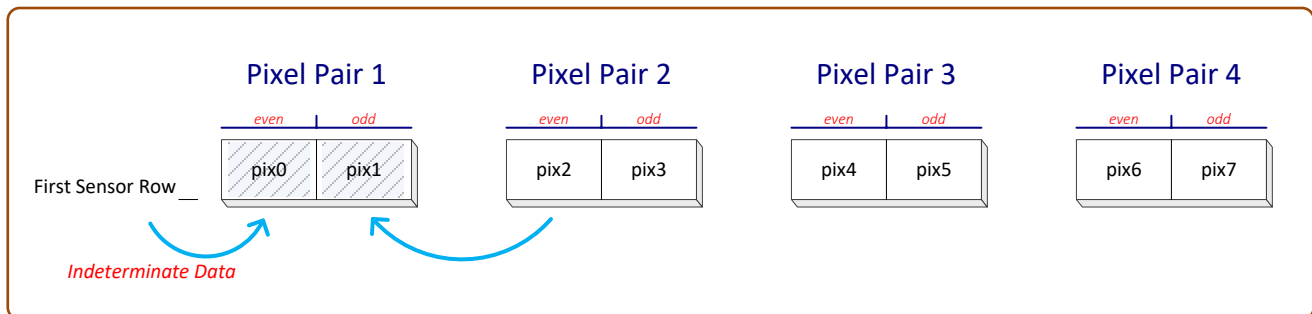

- When the first pixel pair of an image row has both even and odd pixels marked as bad, the even pixel is replaced by pixel from the preceding row's last pixel. The bad odd pixel is replaced by the following even pixel (even if it is also marked as a bad pixel).

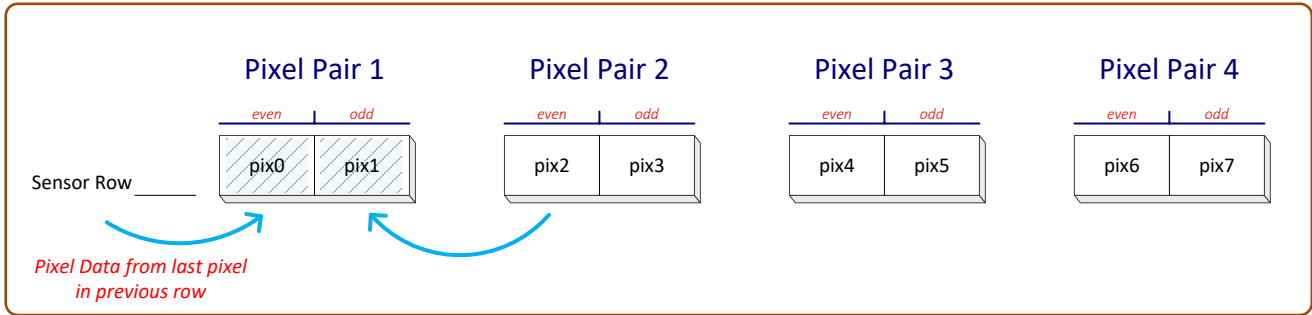

- When a row's last pixel pair has both even and odd pixels marked as bad, the even pixel is replaced by preceding odd pixel and the odd pixel is replaced by the following even pixel which is the following row's first pixel (even if it is also marked as a bad pixel).

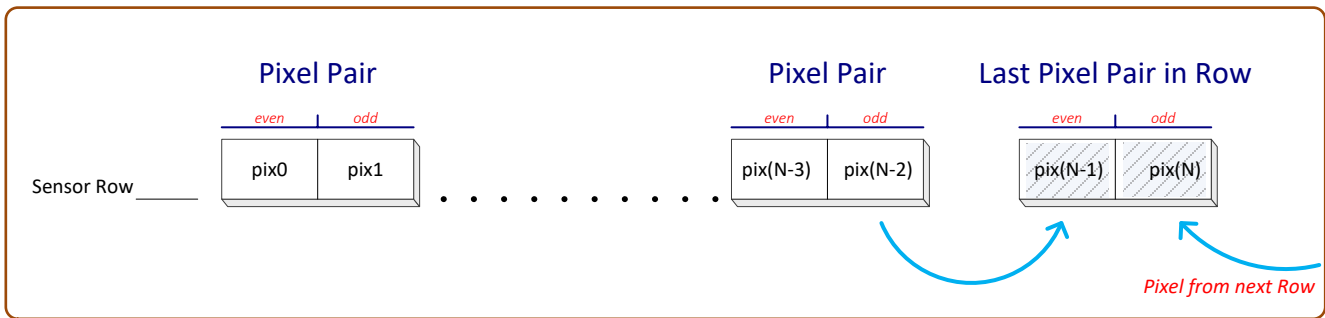

- When the sensor's last row's last pixel pair has both even and odd pixels marked as bad, the even pixel is replaced by preceding odd pixel and the bad odd pixel is replaced by indeterminate data in the following memory location.

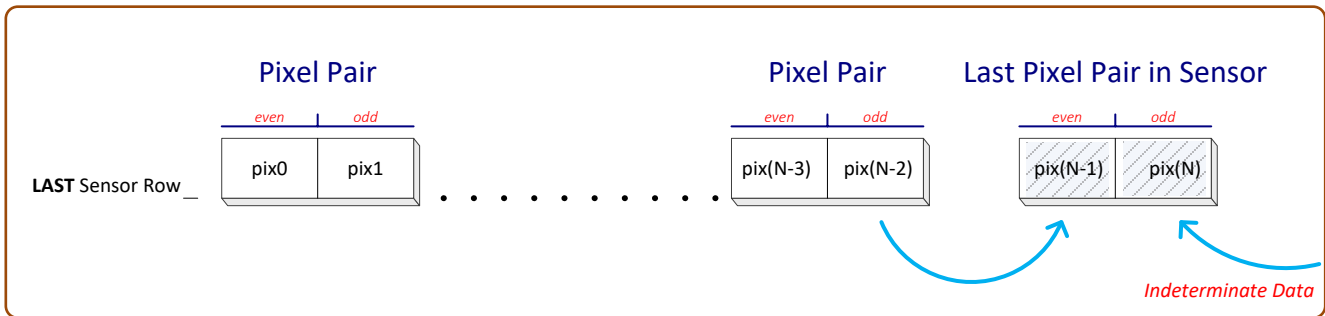

Color Defective Pixel Replacement Algorithm Description

The replacement algorithm rules for Bayer color sensors is similar to the monochrome rules with the exception that replacement pixels of the same color as the bad are used. The two replacement cases below describe general color pixel replacements.

Again there is no embedded intelligence to adapt the rules to avoid replacing a bad pixel with possibly other bad data, but in general these rules provide satisfactory results.

Color Sensors (case 1: single bad pixel)

- A bad even pixel is replaced by the previous even pixel.
- A bad odd pixel is replaced by the following odd pixel.

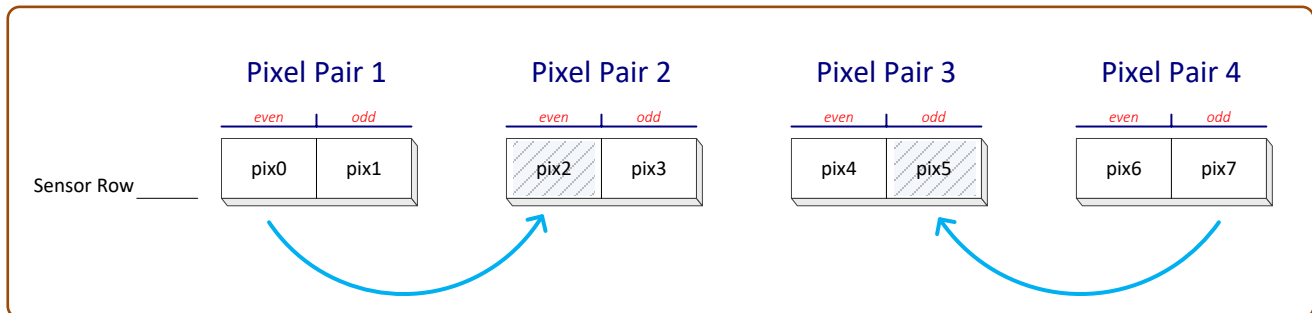

Color Sensors (case 2: bad pixels at line ends)

- If the line's first pixel is bad then the following even pixel (same color) is used as the replacement pixel.
- If the line's last pixel is bad then the preceding odd pixel (same color) is used as the replacement pixel.

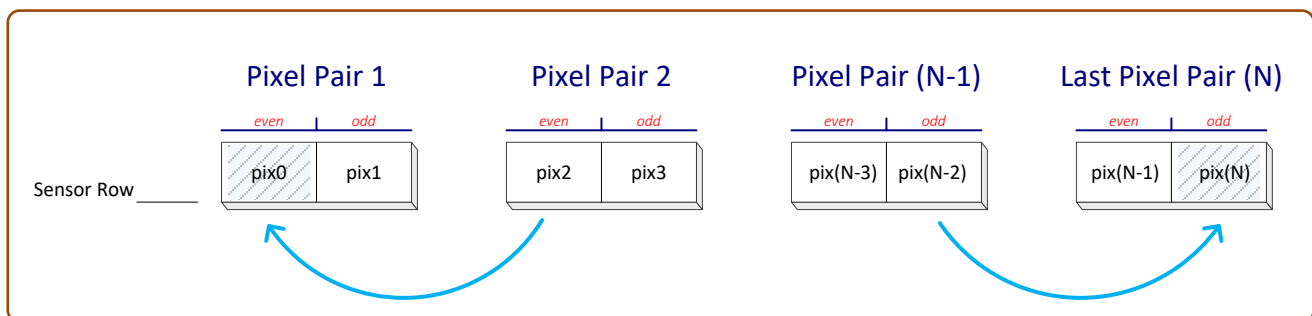

Revision History

Revision	Date	Major Change Description
R:0001	September 15, 2015	Initial release
R:0002	September 17, 2015	Additional I/O technical specifications, etc.
R:0003	September 18, 2015	Additional information on optional accessories, etc.
R:0004	September 23, 2015	Added "EC & FCC Declaration of Conformity" (models M/C1920 & M/C1940), etc.
R:0005	October 1, 2015	Correction to S/N spec. Expansion of TriggerOverlap feature.
R:0006	November 11, 2015	Addition of Cycling, Flip and Metadata features. Additional I/O details on interfacing and operational specifications. Updates to various specifications.
R:0007	January 21, 2016	Addition of OnSemi sensor models with their unique features and specifications.
R:0008	February 22, 2016	Addition of OnSemi sensor models 2M and 5M.
R:0009	March 29, 2016	Additional features and functionality (LUT, Action Commands, PTP support, Modulo Timestamp acquisition control).
R:0010	April 29, 2016	Addition of 4 Sony monochrome sensor models 5.1M and 3.2M w/two sensitivities
R:0011	June 10, 2016	Addition of 4 Sony color sensor models 5.1M and 3.2M w/two sensitivities
R:0012	July 8, 2016	Driver 1.04 adds Auto Brightness, White Balance, Pixel Replacement, etc. features to various camera models.
R:0013	November 3, 2016	Driver 1.05 adds various color model features, plus addition of 4 Sony sensor (Mono/Color) models with 9m and 12M sensors. Optional hardware model with "3 outputs / 1 Input" introduced.
R:0014	January 30, 2017	Addition of low cost Sony sensor Nano models 8.9M and 12M. Addition of NanoXL models using OnSemi 25M and 16M sensors.
R:0015	May 4, 2017	Driver 1.06 adds a few features and improvements. Improvements to information specific to individual models. Introduction of the OnSemi low cost 18M model (with rolling shutter).
R:0016	July 11, 2017	Improvements to information specific to various individual models. Expansions of specification tables to separate firmware versions for readability. Corrections to various model specifications.
R:0017	August 1, 2017	Improvements and corrections to I/O mating connector details and other Hyperlinks.
R:0018	November 7, 2017	Driver 1.07 adds various features. Addition of new models with OnSemi P3 sensors. Addition of Defective Pixel Replacement algorithm Method 3 replacing Method 4.
R:0019	December 4, 2017	Improved camera model specifications. 'Open Source Software Licenses' statement added to camera firmware overview.
R:0020	March 7, 2018	Addition of new models and improved reference information. Release of 1.07.

Contact Information

Sales Information

Visit our web site:	https://pyramidimaging.com
Email:	info@pyramidimaging.com

Address
Pyramid Imaging 945 E. 11th Ave Tampa, FL 33605 Tel: (813) 984-0125 Fax (866) 874-90521

Index

1

10-pin connector, 225

3

3 output models, 279

A

AC Timing Characteristics, 231, 234
Action Command, 191
Action controls, 190
administrator, 88
AdobeRGB, 143
Advanced Processing controls, 135
alternative Nano models, 279
artifacts, 105
Auto Gain, 112
auto image intensity, 111
auto-brightness, 111

B

back focal length, 256
back focal variation, 221
bad pixel map, 139, 280
Bayer output, 105
best clock source, 200
Binning, 178
binning modes, 178
body depth variation, 221

C

Cable options, 16
camera configuration, 98
camera interfacing tool, 92
camera state LED, 84
CamExpert parameters, 90
chuck data – binning, 183
Cognex uninstaller, 278
Color controls, 141, 145
column artifacts, 105
command jitter, 118
Communication problems, 273
Components Express, 265
Components Express Inc., 267
controlling event, 118
counter/timer controls, 128
Cycling Constraints, 155
Cycling controls, 147

cycling preset, 152
cycling setup, 152
cycling timing, 153

D

debounce circuit, 119
defective pixel map file, 139, 280
development platform, 17
device discovery, 90
DHCP, 85
diagnostic LED, 82
dimension, 221
Dust problems, 257

E

effective focal length, 256
electrostatic discharge, 86
embedded processing, 138
ESD, 257
ESD testing, 86
Ethernet cable length, 82
Ethernet switch, 239
event controls, 192
event notification, 233
exposure convergence, 112
exposure duration, 106
exposure period, 274
Extended Unique Identifier, 200
external trigger, 274

F

fast frame rate, 162
Fast Readout Mode artifacts, 105
fiber-optic light sources, 253
file uploads-Linux, 88
firewall exceptions, 87
firmware update, 87
flash memory, 216
flow control protocol, 239
focal point, 256
format controls, 156
Frame Trigger modes, 118

G

gain, 103, 104
gamma adjustments, 138
GenICam Specification, 17, 87
Genie identifier, 90
GigE server tray icon, 89, 270, 271
GigE to fiber-opti, 239
GigE Vision compliant, 85
GigE Vision Host controls, 212
GigE Vision Specification, 10, 17
GigEMetaDataDemo, 184
Global Reset Release, 76

H

halogen light sources, 253
HD video format, 245
heat management, 224
heat transfer, 224
high EMI, 273
high frame rate, 162
horizontal and vertical binning, 178
horizontal crop, 172
hot mirror, 253
HTML help, 17

I

I/O cable assemblies, 258
I/O cable options, 227
I/O cabling, 228
I/O connector, 225
I/O controls, 109, 113
I/O signals, 83
IEEE 1588, 200
IEEE 802.3x, 239
image circles, 245, 246
image exposures, 118
image inversion, 176
Image Lost Event, 188
ImageLost, 189
industrial RJ-45, 267
infrared filters, 253
internal buffer, 188
internal memory, 18
internal pattern, 275
ionized air blower, 257
IP configuration, 82
IP configuration protocol, 83, 85
IR cut-off, 254
IR cut-off filter, 253
IR filter, 143

L

LED light sources, 253
LED states, 84
lens parameters, 252
light source aging, 253
line signals, 119
Link-Local Address, 85
Log Viewer tool, 273
long cable lengths, 273
low-light sensitivity, 178
Luminance, 142, 144
LUT controls, 135
LUT size, 138
LUT table, 138

M

MAC address, 91

Metadata, 180
Metadata controls, 180
Modulation Transfer Function, 76
MTBF, 22
Multiple ROI, 172

N

Nano connectors, 83
Nano rear view, 83
Network Configurations, 85
NIC optimization, 90

O

object distance, 256
operational status, 84
optimize network, 212
opto-coupled outputs, 127

P

packet resend buffer, 211
packet resend conditions, 273
Pause Frame Flow Control, 239
PAUSE Frame support, 82
PDF, 17
Persistent IP, 85
PoE Class 0, 229
power failure during update, 273
Power Over Ethernet, 10
power-up state, 98
Precision Time Protocol, 200
Pre-Processing, 105
procedures for handling, 257
PTP Boundary Clock, 200
PTP Mode, 200

Q

quick start, 81

R

reducing bandwidth, 174
Reliability, 218
Responsivity, 252
retention latches, 225
RGB gain, 143
RGB-Output Design, 141
Right-Angle Cable, 269
RJ45 Ethernet, 225
ROI modes, 172
rolling shutter sensor, 18, 76

S

Sapera LT User's manual, 88
Sapera version, 17

SapLut file, 138
Saturation, 142, 144
screw locks, 225
secure Ethernet cable, 267
secured Ethernet cable, 273
sensor cleaning, 258
sensor controls, 99
Sensor gain, 103
sensor integration period, 106
sensor tolerance, 224
signal debounce circuit, 119
Software Platforms, 17
software triggers, 118
Sony Pregius, 9
spatial resolution, 178
sRGB, 143
status LED, 84
status LED sequence, 84
subnet, 89
synchronous exposure, 106

T

T2IR, 218
T2IR monitoring, 218
Temperature Management, 224
temporal distortion, 76
test pattern generator, 179
third party filter driver, 271
threshold processes, 138
Timestamp Modulo, 201
transfer controls, 186
Transfer Queue, 189
transport layer controls, 206
Trigger-to-Image Reliability, 218
TurboDrive, 9
TurboDrive enable, 212
TurboDrive support, 9
TurboDrive Technology Support, 19

U

Updates, 10
upload files, 212
user defined name, 91
User Map 1, 139, 280
User Name, 91

V

vertical and horizontal cropping, 162
vertical cropping, 162
view metadata, 184
vignetting, 245, 246, 247, 248, 249, 250, 251
visibility attribute, 93

W

White Balance, 142

workstation, 88

X

XML device file, 17