

5 MP 1/1.2"

GM5HR123521MCN

www.GoyoLenses.com

Info@GoyoLenses.com

1-630-566-0580

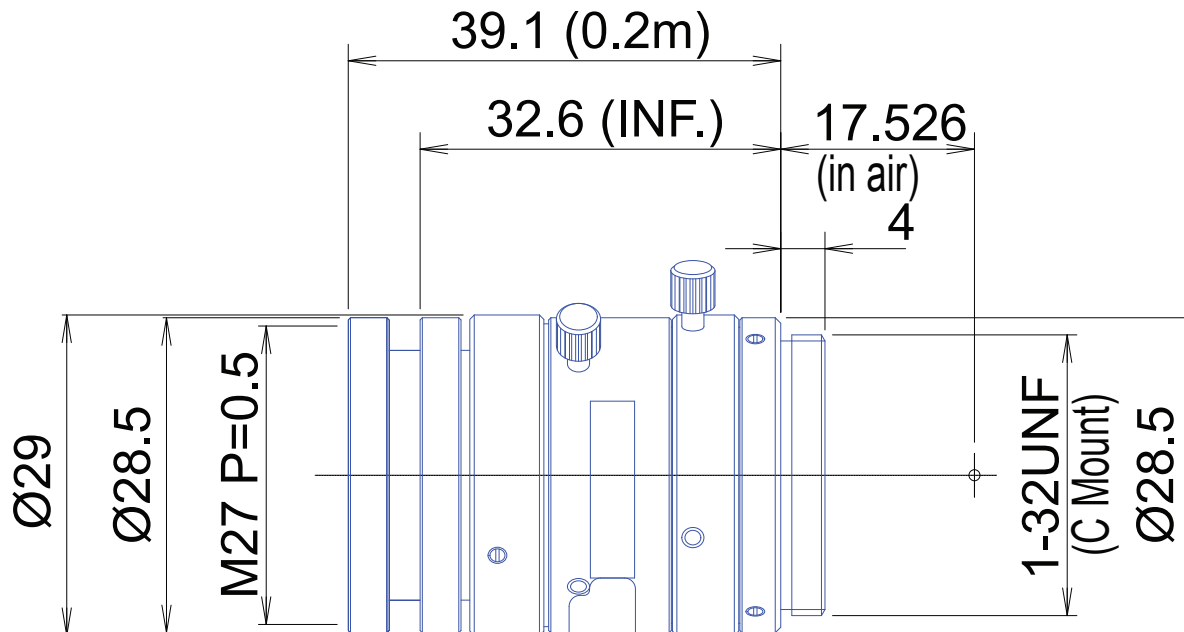

Part No.	GM5HR123521MCN
Focal Length	35mm
Iris Range	f/2.1 - 16
Lens Format	1/1.2"
MOD	200mm
Mount	C
Filter Thread	M27 x P0.5
Angle of View	17.3° x 13.1°
Weight	60g
Dimension (DxL)	Ø29 x 40



945 East 11th Avenue

Tampa, FL 33605

Phone: (813) 984-0125

Contact: Sales@pyramidimaging.com

<https://pyramidimaging.com>